



# HISTORIC DISTRICT COMMISSION APPLICATION FOR WORK APPROVAL

City of Detroit - Planning & Development Department  
2 Woodward Avenue, Suite 808  
Detroit, Michigan 48226

<b>APPLICATION ID</b>
HDC2025-00068

## PROPERTY INFORMATION

<b>ADDRESS(ES):</b> 708 PALLISTER
<b>HISTORIC DISTRICT:</b> New Center Area

**SCOPE OF WORK: (Check ALL that apply)**

- |   |  |  |   |  |                                |
|---|--|--|---|--|--------------------------------|
| <input checked="" type="checkbox"/> Windows/<br>Doors | <input checked="" type="checkbox"/> Walls/<br>Siding | <input checked="" type="checkbox"/> Painting | <input type="checkbox"/> Roof/Gutters/<br>Chimney | <input checked="" type="checkbox"/> Porch/Deck/Balcony   | <input type="checkbox"/> Other |
| <input checked="" type="checkbox"/> Demolition        | <input type="checkbox"/> Signage                     | <input type="checkbox"/> New<br>Building     | <input type="checkbox"/> Addition                 | <input checked="" type="checkbox"/> Site Improvements<br>(landscape, trees, fences,<br>patios, etc.) |                                |

<b>BRIEF PROJECT DESCRIPTION:</b> exterior renovation to add dormers, new siding, front porch and rear deck, repair garage and new windows.
--

## APPLICANT IDENTIFICATION

<b>TYPE OF APPLICANT:</b> Architect/Engineer/Consultant			
<b>NAME:</b> Timothy Flintoff	<b>COMPANY NAME:</b> 4545 Architecture		
<b>ADDRESS:</b> 2761 E. Jefferson Ave, Ste 302	<b>CITY:</b> Detroit	<b>STATE:</b> MI	<b>ZIP:</b> 48207
<b>PHONE:</b> +1 (313) 450-4545	<b>EMAIL:</b> tim.flintoff@4545architecture.com		

## I AGREE TO AND AFFIRM THE FOLLOWING:

- I understand that the failure to upload all required documentation may result in extended review times for my project and/or a denied application.
- I understand that the review of this application by the Historic District Commission does not waive my responsibility to comply with any other applicable ordinances including obtaining appropriate permits (building, sign, etc.) or other department approvals prior to beginning the work.
- I hereby certify that the information on this application is true and correct. I certify that the proposed work is authorized by the owner of record and I have been authorized to make this application as the property owner(s) authorized agent.

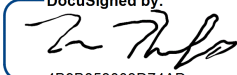
DocuSigned by:  
  
 4B98853003D74AD...

02/18/2025  
 DATE

SIGNATURE





**NOTE: Based on the scope of work, additional documentation may be required. See [www.detroitmi.gov/hdc](http://www.detroitmi.gov/hdc) for scope-specific requirements.**

**PROJECT DETAILS – TELL US ABOUT YOUR PROJECT**



**Instructions: Add project details using the text box in each section. If your details exceed the space provided, attach the details via the attachment icon for that section.**

<b>ePLANS PERMIT NUMBER:</b> <small>(only applicable if you've already applied for permits through ePLANS)</small>	NA
---	----

**GENERAL**

<p><b>1. DESCRIPTION OF EXISTING CONDITION</b>  <i>Please tell us about the current appearance and conditions of the areas you want to change. You may use a few sentences or attach a separate prepared document on the right. (For example, "existing roof on my garage is covered in gray asphalt shingles in poor condition.")</i></p>	
<p><b>2. PHOTOGRAPHS</b>  <i>Help us understand your project. Please attach photographs of all areas where work is proposed.</i></p>	
<p><b>3. DESCRIPTION OF PROJECT</b>  <i>In this box, tell us about what you want to do at the areas described above in box #1. (For example, Install new asphalt shingle roofing at garage.)</i></p>	
<p><b>4. DETAILED SCOPE OF WORK</b>  <i>In this box, please describe all steps necessary to complete the work described in box #3. (For example, "remove existing shingles, replace wood deck as necessary, replace wood eaves, install roof vents, replace rotted fascia boards, paint, clean worksite.")</i></p>	
<p><b>5. BROCHURES/CUT SHEETS</b>  <i>Please provide information on the products or materials you are proposing to install. For example, a brochure on the brand and color of the shingles proposed.</i></p>	

## ADDITIONAL DETAILS

<p><b>6. WINDOWS/DOORS</b> <i>Detailed photographs of window(s) and/or door(s) proposed for replacement showing the condition of the interior and exterior of the window(s) and/or door(s)</i></p>	
<p><b>7. DEMOLITION</b> <i>If demolition is proposed for reasons of structural failure or catastrophic damage, please provide illustrated report from structural engineer or licensed architect.</i></p>	
<p><b>8. SITE IMPROVEMENTS</b> <i>If site improvements are proposed, please provide any relevant site improvement plans pertaining to your project.</i></p>	



February 18, 2025

708 Pallister St.,  
Detroit, MI 48202

RE: 708 Pallister Exterior Renovations

### Project Narrative

708 Pallister is a single family home in the New Center Area historic district. It is located in the middle of the pedestrian-only block of Pallister St., between 3rd Ave. and Bethune Ct. The structure is two stories, with a traditional hip roof and covered porch entry, and an existing street-facing dormer; three new construction dormers have been added in the last year. It features painted horizontal wood siding on the first floor exterior, with painted wood shake above, on traditional wood framing. The street-facing south elevation also features a bay window on the first floor, adjacent to the existing covered porch. The structure is approximately 1557 GSF, plus an attic and basement. The property also has a detached, single-story 2 car garage that is approximately 500 GSF.

The existing front porch has had a painted brick veneer installed to match the existing foundation wall of the house, as well as a new street-facing masonry stair; the existing east-facing stair has been replaced. Two wrapped and painted wood posts have been installed, with plans to install a matching third post, in order to support the existing porch roof. Hip roofs previously built on two of the three new dormers will be removed and replaced with gable roofs to better align with the design of the existing street-facing dormer; they are to have matching overhangs and sloped soffits. Fascia and eave elements are to be painted wood, matching the existing color choices. The installed sliding windows on the new dormers are to be removed and replaced with the casement style which was previously approved by HDC (Anderson 100 series with simulated divided lites). A new casement window of the same style will be installed at the east dormer, which currently has no windows present. All dormers, including the original street-facing dormer, have had composite siding installed; this is to be removed and replaced with a wood shake siding, and painted to match the rest of the house (HDC approved C:4 "Yellowish White" with black wood trim).

A new window has been installed at the east elevation first floor. The installed inset composite trim is to be removed and replaced with a wood trim which sits atop the siding, similar to the trim of the original

# 4545 architecture

windows, with trim member sizing also to match. Further, this new window's inset trim has extended into an existing horizontal 'belt band' which visually separates the first and second stories. The 'belt band' is to be removed and replaced with a painted wood member in the same style that was previously present, extending the width of the elevation and the top of the new window.

At the east elevation second floor and the north elevation first floor, installed sliding windows will be removed and replaced Anderson 400 series casement windows with simulated divided lites in the style of the original windows, and painted black. Two glass block windows at the east elevation will be removed and reset in the same plane as the original basement windows, with appropriate window screens installed in front.

The installed patio door at the rear of the house will be removed and replaced with an aluminum-clad wood french door (Anderson E-series) with a 2-over-1 fractional divided lite configuration. All newly installed windows will have simulated divided lites installed to match the visual style of the previously present windows (see architectural drawings for specific configurations). The rear deck will have Trex composite decking and railing installed in order to be visually/materially distinct from the original house, while the front porch will have wood railing installed.

A heating/cooling unit was installed at the west elevation, along with an electric meter, in the approximately 4'-0" space between the house and existing fence. It is the project's intention to keep this here, as it is less visually present than elsewhere around the house.

PHOTO ELEVATIONS FOR REFERENCE ONLY. SEE ARCHITECTURAL ELEVATIONS FOR FINAL DESIGN DETAILS

ARCHITECT:

**4545** architecture

2781 E. JEFFERSON AVE  
STE 302  
DETROIT, MI 48207  
P. 313.454.4545  
TIM.FLINTOFF@4545ARCHITECTURE.COM

CONSULTANT:

Project :

**708 PALLISTER  
HDC RENOVATION**

Issued for :

**HDC SUBMIT 02/18/2025**



Drawn by :  
**ANJ**

Check by :  
**TFE**

Sheet Title :  
**EXTERIOR  
ELEVATION  
PHOTOS**

Project No. :  
**2024001**

Sheet No. :  
**A3.4**



**1** WEST ELEVATION - JANUARY 2024



**2** WEST ELEVATION - NOVEMBER 26, 2024

DO NOT SCALE DRAWINGS | ©2024 Timothy Flintoff Architect, PLLC



1 SOUTH ELEVATION - JANUARY 2024



3 SOUTH ELEVATION - NOVEMBER 26, 2024



2 NORTH ELEVATION - JANUARY 2024



4 NORTH ELEVATION - NOVEMBER 26, 2024

PHOTO ELEVATIONS FOR REFERENCE ONLY, SEE ARCHITECTURAL ELEVATIONS FOR FINAL DESIGN DETAILS

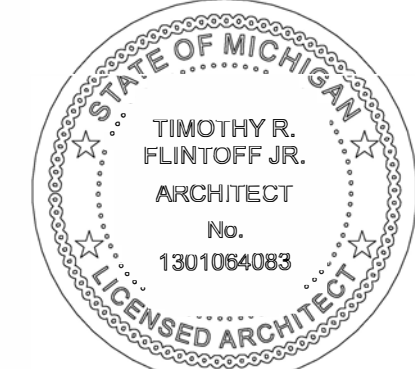
ARCHITECT: <b>4545</b> architecture 2781 E. JEFFERSON AVE STE 302 DETROIT, MI 48207 P. 313.454.4545 TIM.FLINTOFF@4545ARCHITECTURE.COM
CONSULTANT:
Project : <b>708 PALLISTER HDC RENOVATION</b>
Issued for : <b>HDC SUBMIT 02/18/2025</b>

Drawn by : <b>ANJ</b> Check by : <b>THE</b>
Sheet Title : <b>EXTERIOR ELEVATION PHOTOS</b>
Project No. : <b>2024001</b>
Sheet No. : <b>A3.2</b>

DO NOT SCALE DRAWINGS | ©2024 Timothy Flintoff Architect, PLLC

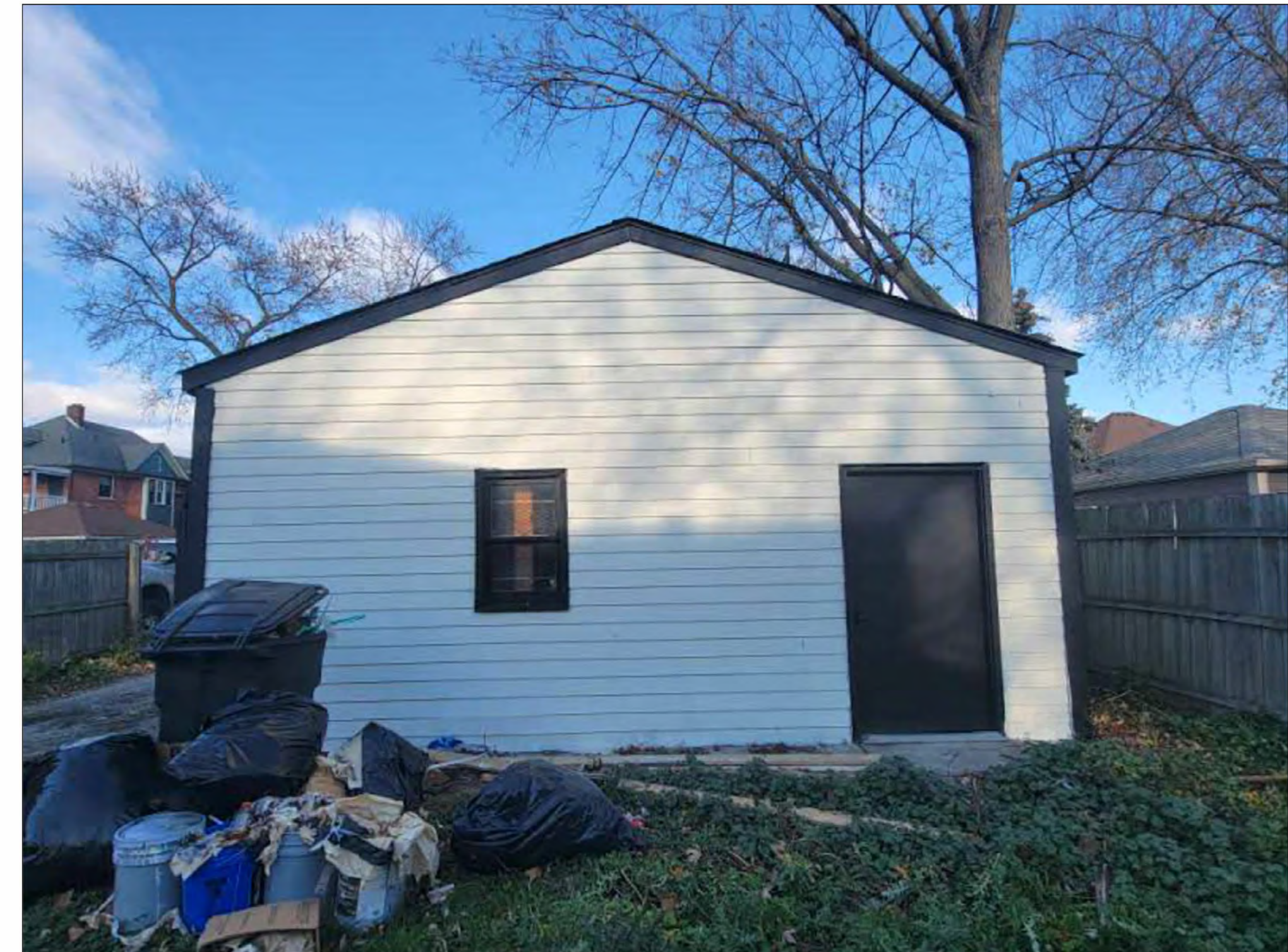

PATCH AND REPAIR AS REQ'D WITH IN-KIND MATERIALS; PAINT (COLORS TO MATCH HOUSE, SEE ELEVATIONS) (TYP.)  
REPLACE EXISTING EXTERIOR DOOR AND HARDWARE  
REPAIR AND PAINT EXISTING WINDOW

1 SOUTH ELEVATION - JANUARY 2024



2 SOUTH ELEVATION - NOVEMBER 26, 2024



PATCH AND REPAIR AS REQ'D WITH IN-KIND MATERIALS; PAINT (COLORS TO MATCH HOUSE, SEE ELEVATIONS) (TYP.)

3 NORTH ELEVATION - JANUARY 2024



4 NORTH ELEVATION - NOVEMBER 26, 2024

ARCHITECT:

4545 architecture

2781 E. JEFFERSON AVE  
STE 302  
DETROIT, MI 48207  
P. 313.454.4545  
TIM.FLINTOFF@4545ARCHITECTURE.COM

CONSULTANT:

Project :  
708 PALLISTER  
HDC RENOVATION

Issued for :  
HDC SUBMIT 02/18/2025



Drawn by :  
ANJ  
Check by :  
THE

Sheet Title :  
GARAGE  
ELEVATIONS AND  
ROOF PLAN

Project No. :  
2024001

Sheet No. :  
A3.5

DO NOT SCALE DRAWINGS | ©2024 Timothy Flintoff Architect, PLLC





PATCH AND REPAIR AS REQ'D WITH IN-KIND MATERIALS; PAINT (COLORS TO MATCH HOUSE, SEE ELEVATIONS) (TYP.)



1 WEST ELEVATION - JANUARY 2024

2 WEST ELEVATION - NOVEMBER 26, 2024



HANGER OR REPLACE ROOF JOISTS, SHEATHING, AND ICE/WATER BARRIER AS REQ'D; (WORK COMPLETED)

REPLACE EXISTING ROOF SHINGLES WITH CERTAINTED LANDMARK PRO ASPHALT ROOF SHINGLES IN CINDER BLACK (WORK COMPLETED)

3 ROOF - JANUARY 2024



ARCHITECT:

4545 architecture

2781 E. JEFFERSON AVE  
STE 302  
DETROIT, MI 48207  
P. 313.454.4545  
TIM.FLINTOFF@4545ARCHITECTURE.COM

CONSULTANT:

Project :

708 PALLISTER  
HDC RENOVATION

Issued for :

HDC SUBMIT 02/18/2025

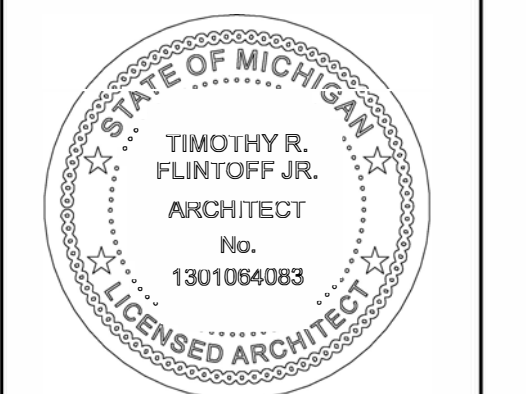

Drawn by :  
ANJ

Check by :  
THE

Sheet Title :  
GARAGE  
ELEVATIONS AND  
ROOF PLAN

Project No. :  
2024001

Sheet No. :

A3.6

PHOTO ELEVATIONS FOR REFERENCE ONLY. SEE ARCHITECTURAL ELEVATIONS FOR FINAL DESIGN DETAILS



1 EAST ELEVATION - JANUARY 2024



3 EAST ELEVATION - NOVEMBER 26, 2024



4 EAST ELEVATION - NOVEMBER 26, 2024



2 EAST ELEVATION - JANUARY 2024



5 EAST ELEVATION - NOVEMBER 26, 2024

ARCHITECT:

4545 architecture

2781 E. JEFFERSON AVE  
STE 302  
DETROIT, MI 48207  
P. 313.454.4545  
TIM.FLINTOFF@4545ARCHITECTURE.COM

CONSULTANT:

Project :

708 PALLISTER  
HDC RENOVATION

Issued for :

HDC SUBMIT 02/18/2025



Drawn by :  
ANJ

Check by :  
TFE

Sheet Title :  
EXTERIOR  
ELEVATION  
PHOTOS

Project No. :  
2024001

Sheet No. :

A3.3

DO NOT SCALE DRAWINGS | ©2024 Timothy Flintoff Architect, PLLC



## PREMIUM HIGH-PERFORMANCE DECKING & FASCIA

Trex Transcend® decking and Trex® Fascia are wood thermoplastic composite lumber (WTCL) boards with an integrated shell that covers the boards on the top surface and sides. The integrated shell consists of a proprietary surface formulation that produces a natural, wood-like grain pattern finish. An alternative to naturally durable hardwood lumber, Transcend Decking and Fascia are ICC-ES SAVE-certified to be a minimum of 95.4% recycled content by weight.

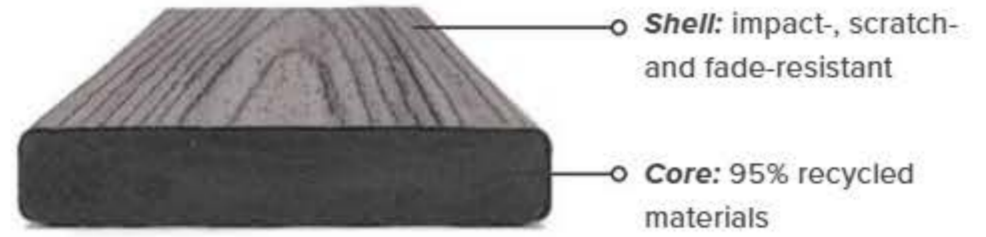

### DECKING

### FASCIA



1" Grooved edge



1" Square edge



2" Square edge



8" or 12" Widths

FEATURES	DECKING BOARDS		FASCIA BOARDS	
	1" x 6"	2" x 6"	8"	12"
Actual Dimensions - Standard	.94" x 5.5"	1.3" x 5.5"	.56" x 7.25"	.56" x 11.375"
Actual Dimensions - Metric	24 mm x 140 mm	33 mm x 140 mm	14 mm x 184 mm	14 mm x 288 mm
Available Lengths - Standard	12', 16', 20'	12', 16', 20'	12'	12'
Available Lengths - Metric	365 cm, 487 cm, 609 cm	365 cm, 487 cm, 609 cm	365 cm	365 cm
Grooved Edge	X			
Square Edge	X	X	X	X
Transcend Lineage*	X		X	X
Transcend Tropicals	X	X	X	X
Transcend Earth Tones	X		X	X
Weight per Lineal Foot	2.4 lbs	3.6 lbs	2.0 lbs	3.3 lbs

\*Transcend® Lineage™ square edge profiles are not available in 12' lengths

**PHYSICAL & MECHANICAL PROPERTIES**

TEST	TEST METHOD	VALUE
Flame Spread	ASTM E 84	Class B
Thermal Expansion	ASTM D 1037	1.9 × 10 <sup>-5</sup> in/in/°F
Moisture Absorption	ASTM D 1037	< 1%
Screw Head Pull-Through	ASTM D1761	161 lbf/screw*
Fungus Resistance	ASTM D1413	Rating – no decay
Termite Resistance	AWPAE1-72	Rating = 9.6

\*Fastener used in testing: #8 x 2.5" approved Stainless Steel Screw

**COLORS**

Lineage (neutral multi-tonal)



Tropicals (vibrant multi-tonal)



Earth Tones (monochromatic)



**FASTENERS**



**Trex Hideaway® Hidden Fastening System**

Self-gapping, glass-filled nylon fastener with 304 grade stainless steel, sharp point screw for wood framing.

Other approved fasteners include, color-matched composite deck screw, matching composite plug with composite screw, color-coordinated fascia screw and uncoated stainless steel fascia screw.

For a full list of approved fasteners, download our Installation Guide at [trex.com/literature](https://www.trex.com/literature)



**RAIL KITS**



*Rail & Square Composite Baluster Kit*



*Rail & Round Aluminum Baluster Kit*



*Cocktail Rail & Round Aluminum Baluster Kit*

COMPONENT	RAIL & SQUARE COMPOSITE BALUSTER KIT	RAIL & ROUND ALUMINUM BALUSTER KIT	COCKTAIL RAIL & ROUND ALUMINUM BALUSTER KIT*
Top Rail	Crown	Crown	Universal
Bottom Rail	Universal	Universal	Universal
Heights	36" (914 mm) 42" (106 cm)	36" (914 mm) 42" (106 cm)	36" (914 mm)
Lengths	67.5" (171 cm) 91.5" (232 cm)	67.5" (171 cm) 91.5" (232 cm)	67.5" (171 cm) 91.5" (232 cm)
Applications	Horizontal, Stair	Horizontal, Stair	Horizontal, Stair
Colors	WT, BK, VL	WT, BK, VL (round aluminum balusters come in BK)	WT (round aluminum balusters come in BK)

\*A cocktail rail allows for a Trex Transcend® or Trex Select® deck board to be installed on top of a Universal top/bottom rail. All deck boards sold separately.

**COLORS**

Composite



Aluminum

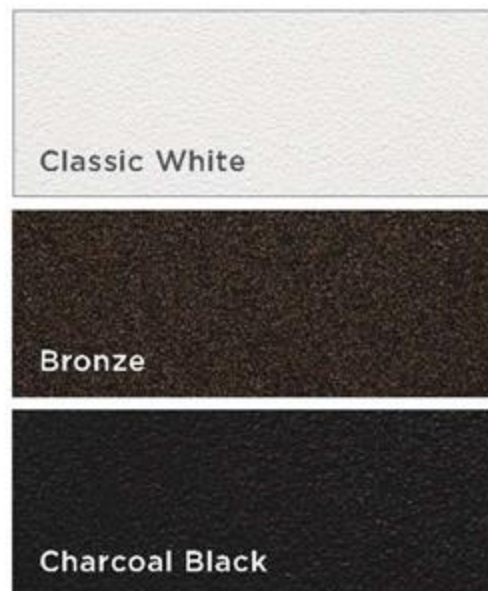

**CODE REQUIREMENTS**

Trex Transcend Railing meets both IRC and IBC designated requirements in accordance with ICC-ES AC174 and ASTM D7032. Refer to Code Compliance Report CCRR-0132 for specific details.

**HARDWARE**

**Mounting Hardware for Cut Rails**

The perfect solution for any installation that requires making two railing sections from one kit.

Includes 2 Crown top rail gaskets, 4 Universal top/bottom rail gaskets, 4 RSB rail brackets, 8 rail-to-bracket fasteners and 8 rail-to-post fasteners.



**QUESTIONS?**

Connect with our pro services team at 1-800-BUY-TREX or [customer@trex.com](mailto:customer@trex.com)



# HYDRA

**DESCRIPTION:** Paver **TEXTURE:** Smooth

## Pallet Overview

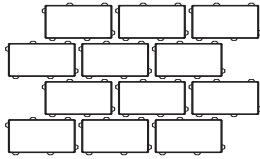

## Specifications per pallet



96 units / pallet

	Imperial	Metric
Product dimension (L x W x H)	11 13/16 x 7 7/8 x 3 15/16	300 x 200 x 100
Cubing	62 ft <sup>3</sup>	5.76 m <sup>3</sup>
Approx. Weight	2 811 lbs	1 275 kg
Number of rows	8	
Coverage per row	7.75 ft <sup>2</sup>	0.72 m <sup>2</sup>
Lin. coverage per row	11.80 lin. ft	3.60 lin. m



Smooth  
Chestnut Brown

Smooth  
Grey

Smooth  
Shale Grey

Smooth  
Onyx Black

## Laying Patterns Options

01 | Linear

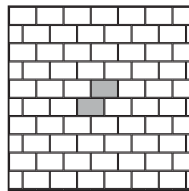

Patterns are for design inspiration only. The installer is responsible to calculate & purchase the correct amount of material.

## NOTES

See page 6 for icons description.  
See page 19 for more information about applications.  
See page 20 and 97 for more technical information.

**JOINT WIDTH:** 1/2" ( 13 mm)  
**% OF SURFACE OPENING:** 8.3 %  
**INFILTRATION RATE:** 605 in./hr (15 345 mm/hr)

## CHARACTERISTICS

- Clamp or Mechanical tool available for machine installation. Check with your local Techo-Bloc representative for more information.
- 6000 to 8000 sq. ft can be installed per day with mechanical installation and a team of 5 persons
- LEED® Projects.
- Reduces stormwater runoff to municipal sewers.
- Eliminates the need for retention basins and optimizes the use of land.





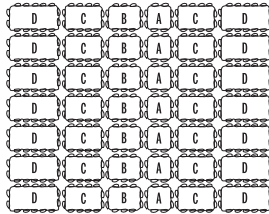

# VILLAGIO

DESCRIPTION: Paver TEXTURE: Beveled

## Pallet Overview



## Specifications per pallet

		Imperial	Metric
<b>A</b>		Product dimension (L x W x H) <b>A</b> 5 1/8" x 5 1/8" x 2 3/8"	130 x 130 x 60
	77 units / pallet	Product dimension (L x W x H) <b>B</b> 6 5/16" x 5 1/8" x 2 3/8"	160 x 130 x 60
<b>B</b>		Product dimension (L x W x H) <b>C</b> 7 5/16" x 5 1/8" x 2 3/8"	185 x 130 x 60
	77 units / pallet	Product dimension (L x W x H) <b>D</b> 8 7/16" x 5 1/8" x 2 3/8"	215 x 130 x 60
<b>C</b>		Cubing	117 ft <sup>2</sup> / 10.88 m <sup>2</sup>
	154 units / pallet	Approx. Weight	2 960 lbs / 1 342 kg
<b>D</b>		Number of rows	11
	154 units / pallet	Coverage per row	10.64 ft <sup>2</sup> / 0.99 m <sup>2</sup>
		Lin. coverage per row	24.94 lin. ft / 7.61 lin. m

## Laying Patterns Options

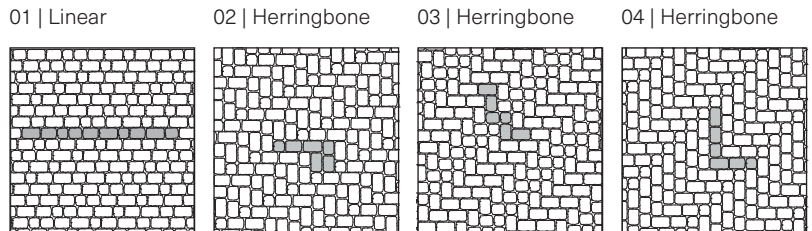

Patterns are for design inspiration only. The installer is responsible to calculate & purchase the correct amount of material.

## NOTES

See page 6 for icons description.  
 See page 19 for more information about applications.  
 See page 56 to 58 for more technical information. When used in a permeable pavement application, see page 93 to 97 for more technical information.

**JOINT WIDTH:** 3/8" to 5/8" (9 to 15 mm)  
**% OF SURFACE OPENING:** 8.0 %  
**INFILTRATION RATE:** 896 in./hr (22 750 mm/hr)  
 The Villagio paver allows for gentle curves and winding pathways, eliminating the need for cuts.



# WOODWRIGHT® DOUBLE-HUNG FULL-FRAME WINDOWS

- Tables of Sizes ..... 50-56
- Specifications ..... 54-61
- Custom Sizes ..... 62
- Grille Patterns ..... 63
- Window Details ..... 63-64
- Joining Details ..... 65
- Combination Designs ..... 181
- Product Performance ..... 197

**CUSTOM SIZING**  
in 1/8" (3) increments 

Dimensions in parentheses are in millimeters.



# WOODWRIGHT® DOUBLE-HUNG FULL-FRAME WINDOWS



## 400 SERIES

### FEATURES

#### FRAME

**A** Perma-Shield® exterior cladding protects the frame – beautifully. Best of all, it's low maintenance and never needs painting.\*

**B** For exceptional long-lasting performance, sill members are constructed with a wood core and a Fibrex® material exterior.

**C** Natural wood stops are available in pine, maple, oak and prefinished white. Wood jamb liners add beauty and authenticity to the window interior.

**D** A factory-applied rigid vinyl flange on the head, sill and sides of the outer frame helps secure the unit to the structure.

**E** Multiple weatherstrip systems help provide a barrier against wind, rain and dust. The combination of spring-tension vinyl, rigid vinyl and flexible bulb weatherstrip is efficient and effective.

**F** For units with white exterior color, the exterior jamb liner is white. For all other units, the exterior jamb liner is gray.

#### SASH

**G** Balancers in the sash enable contractors to screw through the jamb during installation without interfering with the window's operation.

#### Wood Jamb Liner

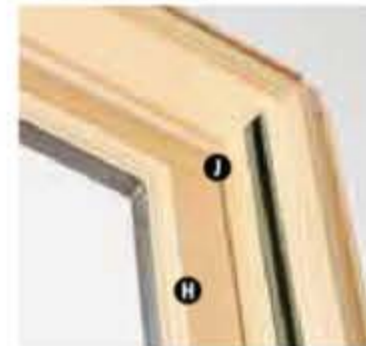

**H** Natural wood sash interior with classic chamfer detailing. Available in pine, maple, oak or prefinished white.

**I** Low-maintenance sash exterior provides long-lasting protection and performance. Sash exteriors on most units include Fibrex material.

**J** Sash joints simulate the look of traditional mortise-and-tenon construction inside and out.

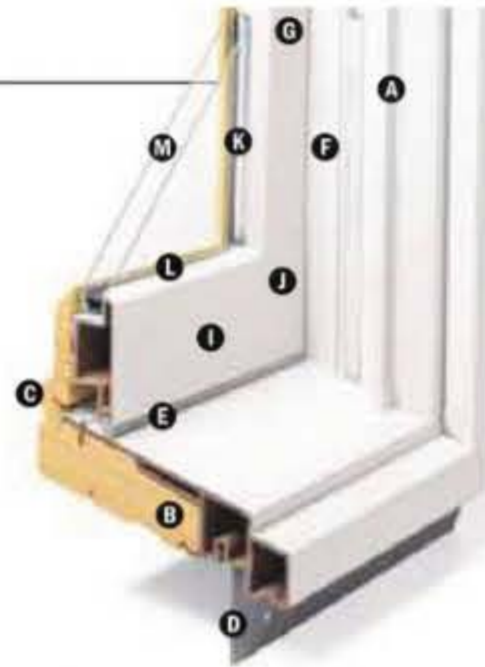

#### GLASS

**K** In addition to stainless steel glass spacers, black or white glass spacers are now available to allow the spacer to blend in with the unit color.

**L** Silicone bed glazing provides superior weathertightness and durability.

**M** High-Performance options include:

- Low-E4® glass
- Low-E4 HeatLock® glass
- Low-E4 SmartSun™ glass
- Low-E4 SmartSun HeatLock glass
- Low-E4 Sun glass

Tempered and other glass options are available. Contact your Andersen supplier.

A removable translucent film helps shield the glass from damage during delivery and construction, and simplifies finishing at the job site.

#### Patterned Glass

Patterned glass options are available. See page 12 for more details.

#### HARDWARE



Standard lock and keeper design provides an easy tilt-to-clean feature integrated into the lock.

### EXTERIOR & INTERIOR OPTIONS

#### EXTERIOR COLORS



#### INTERIOR OPTIONS



### HARDWARE



Standard Lock & Keeper

Antique Brass | **Black** | Bright Brass  
Brushed Chrome | Distressed Bronze  
Distressed Nickel | Gold Dust  
Oil Rubbed Bronze | Polished Chrome  
Satin Nickel | Stone | White

### OPTIONAL HARDWARE Sold Separately

#### CONTEMPORARY



Bar Lift

Available in all hardware finishes. Shown in **Distressed Nickel**.

#### ESTATE™



Hand Lift | Finger Lifts

Antique Brass | Bright Brass  
Brushed Chrome | Distressed Bronze  
Distressed Nickel | Oil Rubbed Bronze  
Polished Chrome | **Satin Nickel**

#### TRADITIONAL



Bar Lift | Hand Lift | Finger Lifts

Antique Brass | **Black** | Bright Brass | Brushed Chrome  
Distressed Bronze | Distressed Nickel | Gold Dust | **Oil Rubbed Bronze**  
Polished Chrome | Satin Nickel | Stone | White

#### CLASSIC SERIES™



Bar Lift | Hand Lift | Finger Lifts

Stone | **White**

Bold name denotes finish shown.

### HARDWARE FINISHES



\*Visit [andersenwindows.com/warranty](http://andersenwindows.com/warranty) for details.

Dimensions in parentheses are in millimeters.

Printing limitations prevent exact replication of colors and finishes. See your Andersen supplier for actual color and finish samples.

Naturally occurring variations in grain, color and texture of wood make each window one of a kind. All wood interiors are unfinished unless a finish is specified.

Distressed bronze and oil rubbed bronze are "living" finishes that will change with time and use.

### StormWATCH PROTECTION

#### Performance Grade (PG) Upgrades

Performance upgrades are available for select sizes of standard, non-impact Woodwright® windows allowing these units to achieve higher performance ratings.

Performance Grade (PG) ratings are more comprehensive than Design Pressure (DP) ratings for measuring product performance. For up-to-date performance information of individual products, visit [andersenwindows.com](http://andersenwindows.com). Use of this option will subtract 3/8" (16) from clear opening height. Contact your Andersen supplier for availability.

Visit [andersenwindows.com/coastal](http://andersenwindows.com/coastal) for more information on Stormwatch® Protection.

#### SHAPES

Woodwright windows are available in the following shapes.



Double-Hung | Springline™ Single-Hung



Arch Double-Hung | Unequal Leg Arch Double-Hung

#### SASH OPTIONS\*



Cottage | Reverse Cottage

\*Shown on 400 Series tilt-wash double-hung windows.

\*\*Do not add combination units to windows with Low-E4 Sun glass unless window glass is tempered. Combination units may also reduce the overall clear operable area of the window. See your local code official for egress requirements in your area.

†TruScene insect screens let in over 25% more fresh air than standard Andersen fiberglass insect screens.

Dimensions in parentheses are in millimeters.

### ACCESSORIES Sold Separately

#### FRAME

##### Extension Jamb



Standard jamb depth is 4 1/2" (114). Extension jambs are available in unfinished pine or prefinished white. Some sizes may be veneered.

Factory-applied and non-applied interior extension jambs are available in 1/16" (1.5) increments between 5 1/4" (133) and 7 1/8" (181). Extension jambs can be factory applied to either three sides (stool and apron application) or four sides (picture frame casing).

##### Pine Stool



A clear pine stool is available and ready for finishing. The Woodwright stool is available in 4 9/16" (116) for use in wall depths up to 5 1/4" (133) and 6 9/16" (167) for use in wall depths up to 7 1/8" (181). Works with 2 1/4" (57) and 2 1/2" (64) casing widths. Shown above on a 400 Series tilt-wash double-hung window.

#### HARDWARE

##### Window Opening Control Device



A window opening control device is available, which limits sash travel to less than 4" (102) when the window is first opened. Available factory applied, or as a field-applied kit in stone or white.

##### STORM/INSECT SCREEN COMBINATION UNIT\*\*



A self-storing storm window combined with an insect screen provides greater energy efficiency, while allowing ventilation when needed.

Constructed with an aluminum frame, single-pane upper and lower glass panels, and charcoal powder-coated aluminum screen mesh. Available in white, Sandtone and Terratone to match product exteriors. Canvas, dark bronze, forest green and black are available by special order.

Combination units can improve Sound Transmission Class (STC) and Outdoor Indoor Transmission Class (OITC) ratings. Ideal for projects near airports, busy roadways or other noisy environments. For example, adding a combination unit to a 400 Series tilt-wash double-hung (3862) unit with Low-E4® glass will improve its STC rating from 26 to 32. Contact your Andersen supplier for additional STC and OITC rating information.

#### INSECT SCREENS

##### Insect Screen Frames



Choose full insect screen or half insect screen. Half insect screen (shown above) allows ventilation without affecting the view through the upper sash. Frames are available in colors to match product exteriors.

##### TruScene® Insect Screens

Andersen TruScene insect screens let in over 25% more fresh air† and provide 50% greater clarity than conventional Andersen insect screens, all while keeping out unwanted small insects.

##### Conventional Insect Screens

Conventional insect screens have charcoal powder-coated aluminum screen mesh.

#### GRILLES

Grilles are available in a variety of configurations and widths. For double-hung grille patterns, see page 63.

#### EXTERIOR TRIM

Available with Andersen® exterior trim. See exterior trim section starting on page 175.

#### CAUTION:

- Painting and staining may cause damage to rigid vinyl.
- 400 Series windows in Terratone color may be painted any color lighter than Terratone color using quality oil-based or latex paint.
- Do not paint 400 Series windows with white, canvas, Sandtone, dark bronze, forest green or black exterior colors.
- Andersen does not warrant the adhesion or performance of homeowner-applied paint over vinyl or other factory-coated surfaces.
- For vinyl painting instructions and preparation, contact your Andersen supplier.
- Do not paint weatherstrip.
- Creosote-based stains should not come in contact with Andersen products.
- Abrasive cleaners or solutions containing corrosive solvents should not be used on Andersen products.

# WOODWRIGHT® DOUBLE-HUNG FULL-FRAME WINDOWS



## 400 SERIES

### Woodwright® Double-Hung Window Details

Scale 1 1/2" (38) = 1'-0" (305) – 1:8

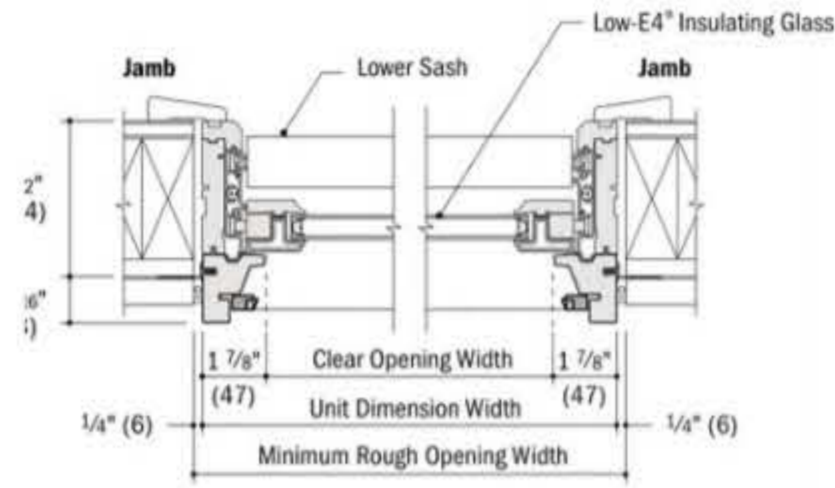

Horizontal Section

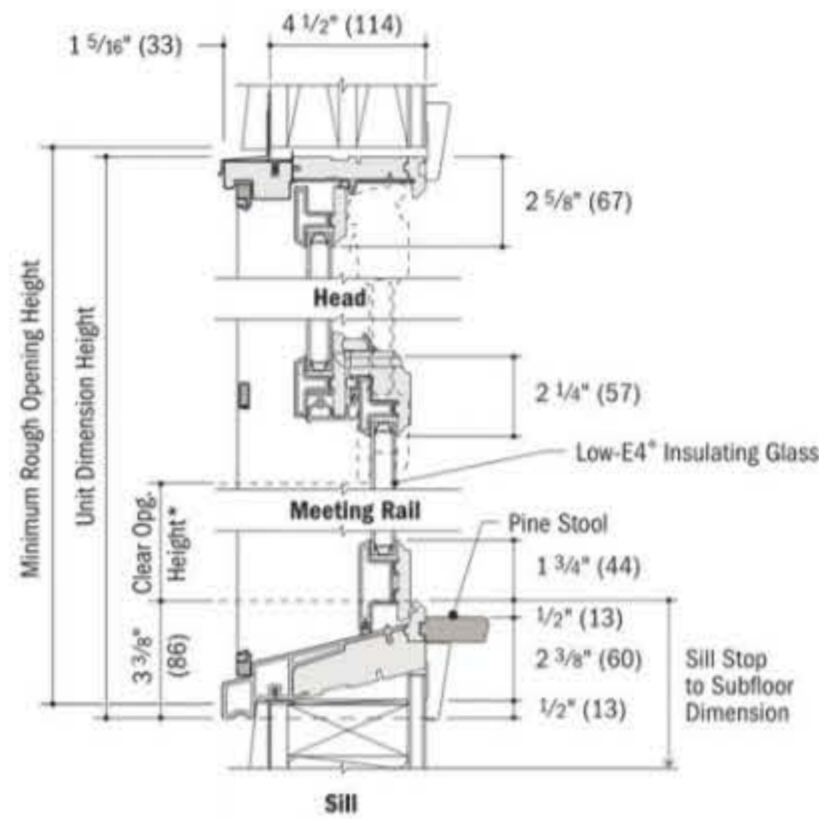

Vertical Section

### Woodwright® Picture Window Details

Scale 1 1/2" (38) = 1'-0" (305) – 1:8

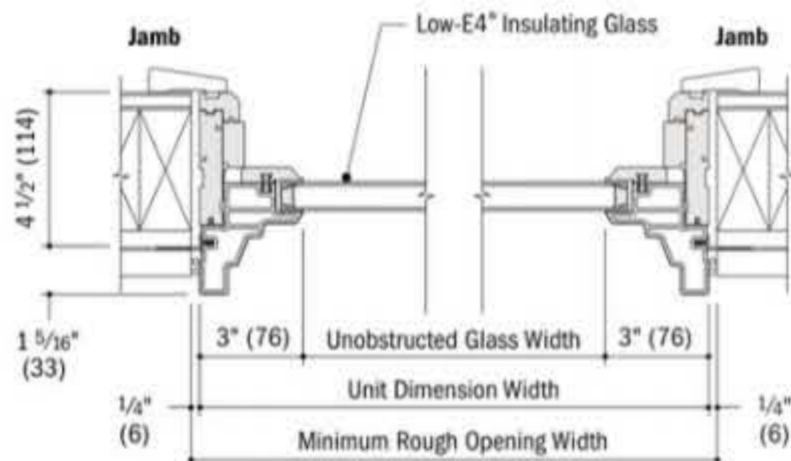

Horizontal Section

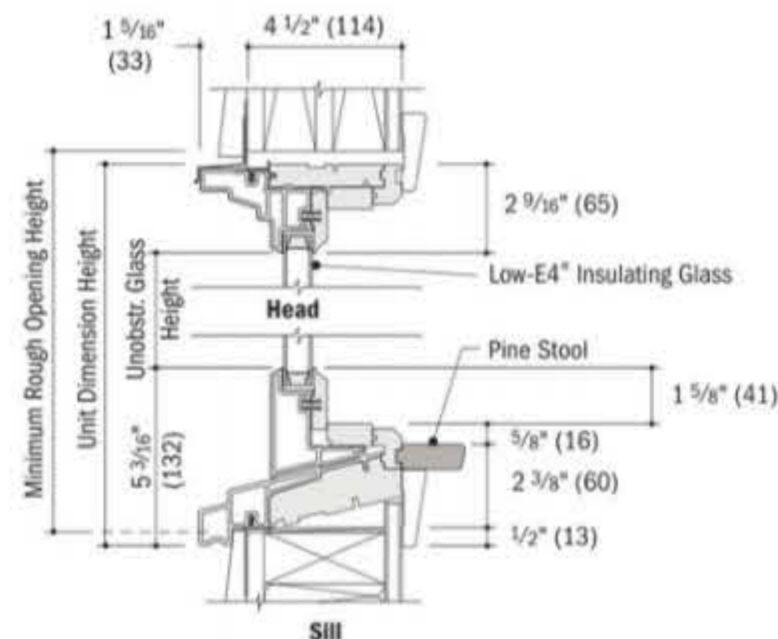

Vertical Section

### Horizontal (stack) Joining Detail

Scale 1 1/2" (38) = 1'-0" (305) – 1:8

#### Overall Window Dimension Height

Sum of individual window heights plus 1/16" (1.5) for each join.

#### Overall Rough Opening Height

Overall window dimension height.\*

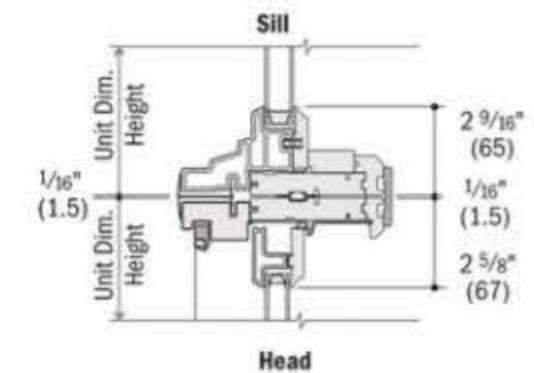

Woodwright® Transom (WTR) over Woodwright Double-Hung

### Vertical (ribbon) Joining Detail

Scale 1 1/2" (38) = 1'-0" (305) – 1:8

#### Overall Window Dimension Width

Sum of individual window widths plus 1/16" (1.5) for each join.

#### Overall Rough Opening Width

Overall window dimension width plus 1/2" (13).

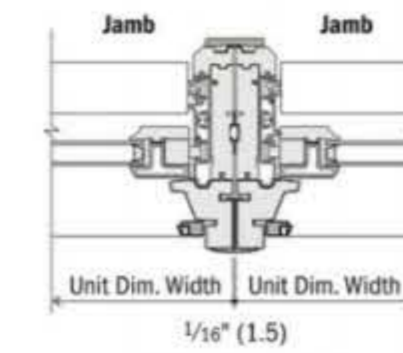

Woodwright® Double-Hung to Woodwright Double-Hung

For more joining information, see the combination designs section starting on page 181.

### Separate Rough Openings Detail

Scale 1 1/2" (38) = 1'-0" (305) – 1:8

To meet structural requirements or to achieve a wider joined appearance, windows may be installed into separate rough openings having vertical support (by others) in combination with Andersen® exterior filler and exterior vinyl trim.

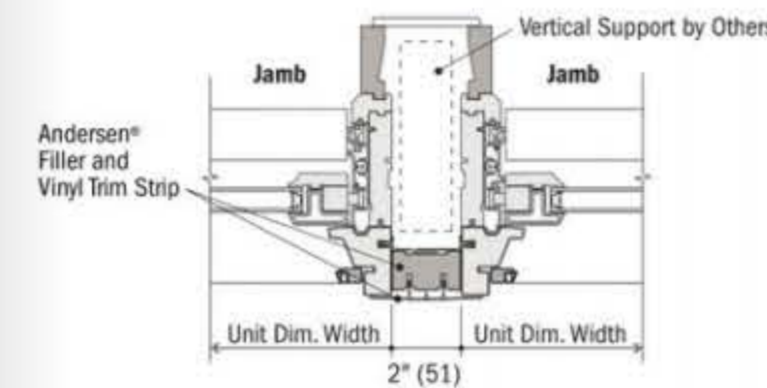

Woodwright® Double-Hung and Woodwright Double-Hung

\*Light-colored areas are parts included with window. Dark-colored areas are additional Andersen® parts required to complete window assembly as shown.  
 • Minimum rough openings may need to be increased to allow for use of building wraps, flashing, sill panning, brackets, fasteners or other items. See installation information on pages 210-211.  
 • Details are for illustration only and are not intended to represent product installation methods or materials. Refer to product installation guides at andersenwindows.com.  
 • Dimensions in parentheses are in millimeters.  
 • Clear opening height dimension is less on arch, unequal leg arch and Springline® hung windows.

\*Light-colored areas are parts included with window. Dark-colored areas are additional Andersen® parts required to complete window assembly as shown.  
 • Minimum rough openings may need to be increased to allow for use of building wraps, flashing, sill panning, brackets, fasteners or other items. See installation information on pages 210-211.  
 • Details are for illustration only and are not intended to represent product installation methods or materials. Refer to product installation guides at andersenwindows.com.  
 • Consult with an architect or structural engineer regarding minimum requirements for structural support members between adjacent rough openings.  
 • Dimensions in parentheses are in millimeters.  
 • For stacks where bottom unit in combination is a double-hung or picture window with a sloped sill. If bottom window has a flat sill, add 1/2" (13) to the overall window dimension height.



# 100 SERIES



**A MODERN LOOK  
THAT'S EASY ON THE BUDGET**

## CONTENTS

Performance & Durability	2-3
Fibrex® Material	4-5
Window & Door Types	6-7
Window Frame Options	8-9
Exteriors & Interiors	10
Hardware	11
Glass	13
Grilles & Insect Screens	14
Build Bigger Views	16

### 100 SERIES WINDOWS

Windows Overview	17
Casement Windows	20
Awning Windows	27
Single-Hung Windows	32
Gliding Windows	55
Picture, Transom & Specialty Windows	68

### 100 SERIES PATIO DOORS

Patio Doors Overview	99
Gliding Patio Doors	101
Patio Door Sidelights & Transoms	103

Combination Designs	107
Product Performance	111
Installation Accessories & Information	120
Sustainability	123

For warranty information, visit [andersenwindows.com/warranty](https://andersenwindows.com/warranty)



Andersen Corporation, including its subsidiaries, has been named a 2023 ENERGY STAR® Partner of the Year – Sustained Excellence Award winner, the highest honor given by ENERGY STAR, for continued leadership in protecting the environment through superior energy efficiency achievements.

\*ENERGY STAR® is a registered trademark of the U.S. Environmental Protection Agency.

# AMERICA'S MOST LOVED BRAND OF WINDOWS & DOORS\*

You want to give your customers a home they love, and we're here to make that easy for you. That's why we're proud to offer you products that rate #1 in quality and performance,† and to be the #1 trusted and recommended window and door brand\*\* by pros.

## 100 SERIES PRODUCTS

The best way to give your customers a modern look that's within budget and lasts! The 100 Series product line is made from our proprietary Fibrex® material that's energy efficient, environmentally responsible and stronger than vinyl.

\*2022 Andersen brand surveys of U.S. realtors, contractors, builders and homeowners.  
 \*\*2022 Andersen brand surveys of U.S. contractors, builders, architects and homeowners.  
 †Visit [andersenwindows.com/warranty](https://andersenwindows.com/warranty) for details.

## PERFORMANCE

100 Series products simply perform like modern windows and doors should. They're made from our proprietary Fibrex® material, which is extremely low maintenance and blocks thermal transfer 700 times better than aluminum to help your customers save money on heating and cooling costs.

### ATTRACTIVE CORNER SEAMS

Low-visibility corner seams for a cleaner and more modern look.

### COLORS THAT LAST

Durable factory-finished interiors and exteriors never need painting and won't fade, flake, blister or peel,\* even in extreme cold or heat.

### ATTRACTIVE MATTE INTERIORS

Premium matte finish isn't shiny like vinyl and is available in white, Sandtone, dark bronze and black.\*\*

### ENERGY EFFICIENT IN EVERY CLIMATE

Energy-efficient 100 Series products are available with options that make them ENERGY STAR® v. 7.0 certified throughout the U.S. so they can help reduce heating and cooling bills.

Visit [andersenwindows.com/energystar](https://andersenwindows.com/energystar) for more information and to verify that the product with your glass option is certified in your area.



### DESIGNED FOR PERFORMANCE

100 Series products are designed to meet or exceed performance requirements in all 50 states! See [pages 112-113](#) for details.



### EASY TO OPERATE FOR YEARS TO COME

All 100 Series products are tested to the extreme to deliver years' of smooth, reliable operation.

### SUPERIOR WEATHER RESISTANCE

Our weather-resistant construction seals out drafts, wind and water so well that your reputation is protected whatever the weather.

### QUALITY SO SOLID, THE WARRANTY IS TRANSFERABLE\*

Many other window and door warranties end when a home is sold, but our coverage – 20 years on glass, 10 years on non-glass parts – transfers from each owner to the next. And because it's not prorated, the coverage offers full benefits year after year, owner after owner. So it can add real value when you decide to sell your home.

### OWNER2OWNER LIMITED WARRANTY

## DURABILITY

Think vinyl, only stronger. The proprietary Fibrex® material in our 100 Series products has all the benefits of vinyl while holding up better to weather and wear. This way your customers' windows and doors are better protected from warping and cracking, even in tough climates.



The finish on 100 Series products has superior scratch resistance compared to painted vinyl windows\*\* so they'll look beautiful for years to come.



Fibrex material retains its stability and rigidity in all climates, delivering exceptional durability. It makes our 100 Series products rigid and strong so the weathertight seals stay weathertight.



100 Series products can withstand temperatures up to 150°F, even for dark colors, meaning they won't warp due to sun exposure.

\*Visit [andersenwindows.com/warranty](https://andersenwindows.com/warranty) for details.

\*\*When 100 Series products were tested against five leading competitors' painted vinyl window products.



\*Visit [andersenwindows.com/warranty](https://andersenwindows.com/warranty) for details.

\*\*Products with Sandtone, dark bronze and black interiors have matching exteriors.

†See your local code official for code requirements in your area.

‡100SHS4066 PGUP +50/-50 (AAMA/WDMA/CSA 101/1.5.2/A440-08 & -11). Optional PG50 performance grade upgrade is available for most sizes. For more information, visit [andersenwindows.com/100series](https://andersenwindows.com/100series).

\*ENERGY STAR® is a registered trademark of the U.S. Environmental Protection Agency.

## FIBREX® MATERIAL

Developed by Andersen, Fibrex material is a revolutionary structural composite material that blends the very best attributes of vinyl and wood. Fibrex material saves on natural resources because it's composed of 40% reclaimed wood fiber by weight. Special polymer formulations surround and fill each wood fiber, enabling top performance. The result is a material that provides uncommon value and enhances the quality of any project. In use for over two decades in Andersen® products, Fibrex material has proven its strength and durability in all types of climates.

### REVOLUTIONARY BUILDING MATERIAL

- Twice as strong as vinyl so weathertight seals stay weathertight
- Blocks thermal transfer nearly 700 times better than aluminum to help reduce heating and cooling bills
- Retains its stability and rigidity in all climates for exceptional durability
- Offers superior scratch resistance compared to painted vinyl\*

### ENVIRONMENTALLY RESPONSIBLE

- Since Andersen developed the highly sustainable Fibrex material, reuse of waste wood fiber has prevented the harvesting of nearly 90 million board feet of timber
- 100 Series products can help builders earn LEED® points in three key categories: Energy & Atmosphere, Materials & Resources and Indoor Environmental Quality
- 100 Series products meet or exceed California Section 01350 Specification, a California indoor emission standard – one of the toughest in the country
- Like all Andersen products, 100 Series products are designed to last\*\* and help reduce future waste streams



See how Andersen created Fibrex material at [andersenwindows.com/fibrex](http://andersenwindows.com/fibrex)



\*Visit [andersenwindows.com/warranty](http://andersenwindows.com/warranty) for details.

\*\*When tested against five leading competitors' painted vinyl window products.

### STABLE & PREDICTABLE

Fibrex® material is twice as stiff as vinyl. This strength makes it a better choice over time.

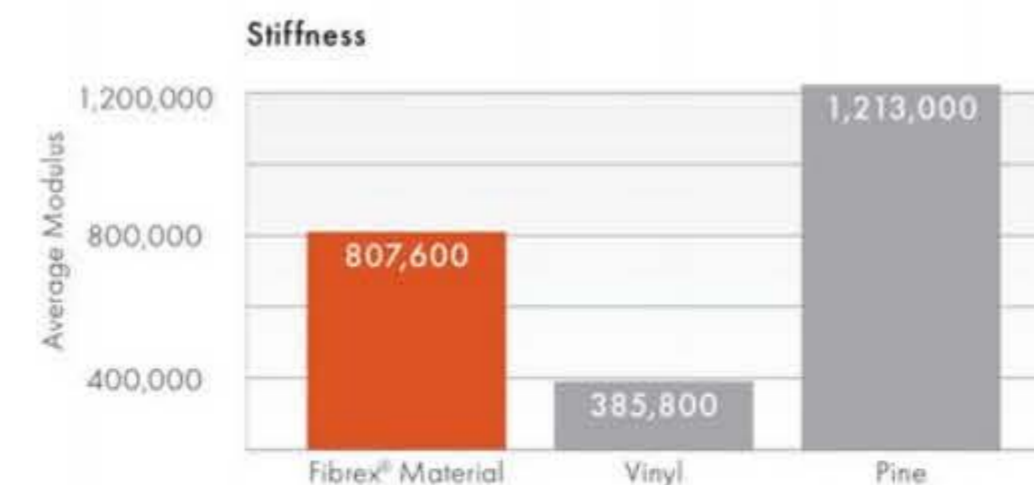

### DURABLE & RELIABLE

All materials expand and contract when exposed to extreme temperatures. In these types of conditions, Fibrex material performs twice as well as vinyl, which can bow and crack over time.

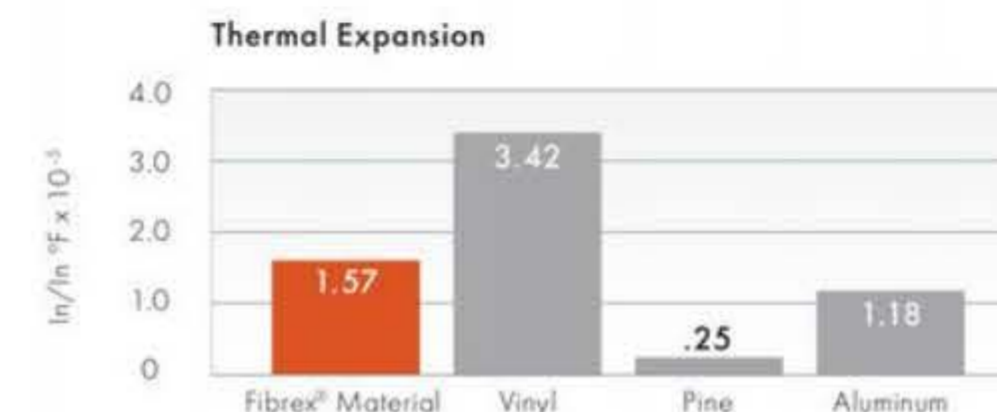

### EXCELLENT INSULATOR

The built-in thermal qualities of Fibrex material mean that less heat and cold get transferred through the product into your customers' homes. As an insulator, it's on par with vinyl and far superior to aluminum.

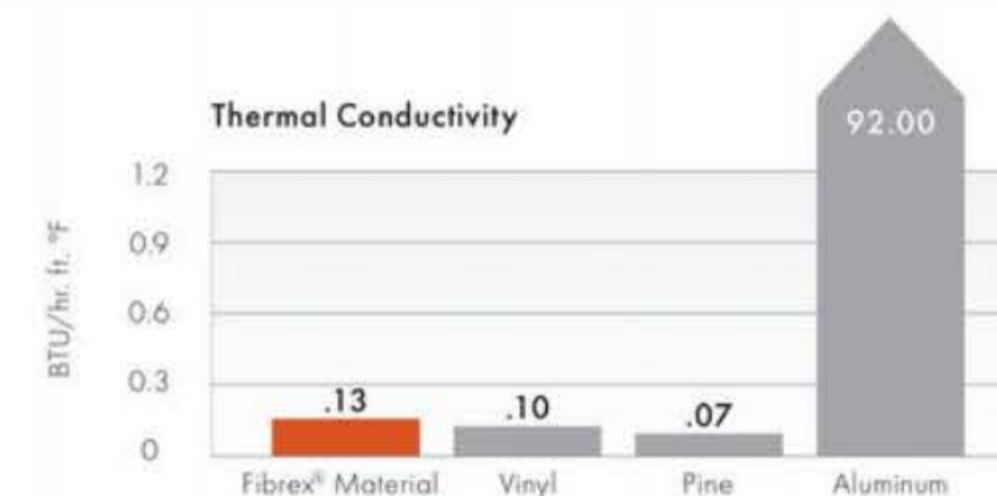

### MOISTURE RESISTANT

Because Fibrex material combines wood fiber and a special polymer formula, water has a tough time penetrating. The result is an increased resistance to rot.

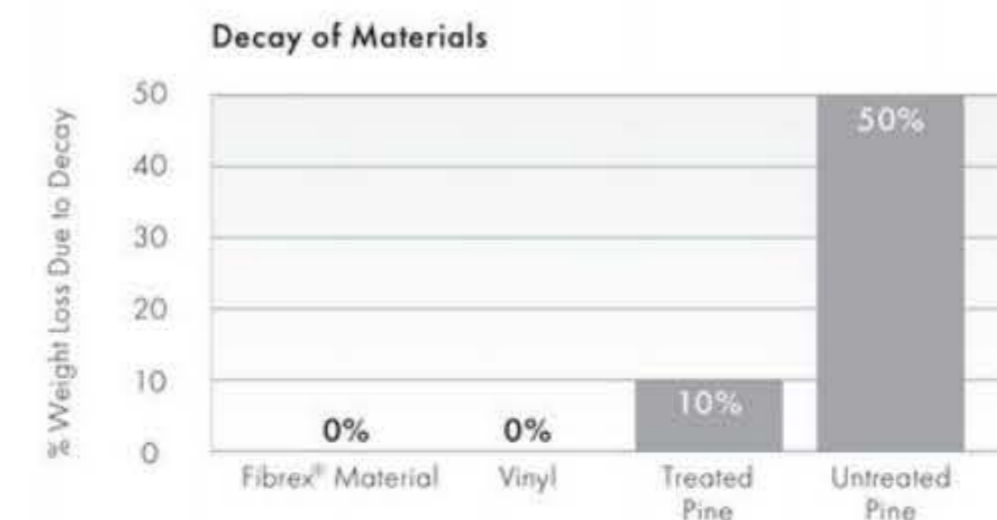

### HEAT RESISTANT

Fibrex material can withstand temperatures in excess of 150°F, even for dark colors, making it a great fit for your projects in hot climates.

# WINDOW & DOOR TYPES

## CASEMENT & AWNING WINDOWS

Casement windows are hinged on the side and open outward to the left or right, while awning windows are hinged at the top and open outward. Both are also available as non-operating stationary windows.



Twin Casement



Picture With Flanking Casements

## SINGLE-HUNG WINDOWS

Single-hung windows feature a fixed upper sash with an operable lower sash that slides up and down. For convenience, the hardware locks automatically when the window is closed. An arch single-hung is also available to add architectural interest.

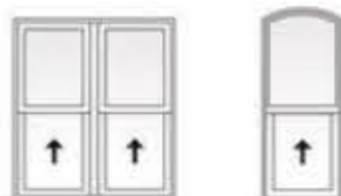

Twin Single-Hung Arch Single-Hung



Picture With Flanking Single-Hungs

## GLIDING WINDOWS

Gliding windows have one stationary sash and one operating sash that glides horizontally. A three-sash configuration, where two sash glide past a fixed center sash, is also available.



Gliding Active-Stationary Gliding Stationary-Active

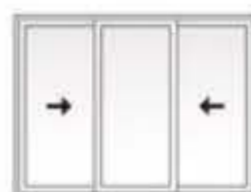

Gliding Active-Stationary-Active, 1:1:1 Sash Ratio

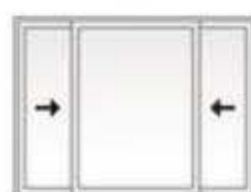

Gliding Active-Stationary-Active, 1:2:1 Sash Ratio

## PICTURE, TRANSOM & SPECIALTY WINDOWS

Choose from a variety of shapes to make a signature statement or provide a delicate lighting accent. Shapes include picture, transom, half circle, quarter circle, circle, Springline™ and arch windows. Custom shapes are also available, including unequal leg arch, trapezoid, pentagon, octagon and triangle windows.



## GLIDING PATIO DOORS

Patio doors feature one stationary panel and one operating panel that glides smoothly on adjustable rollers. They feature a multi-point locking system for enhanced security and an optional exterior keyed lock for convenience. Sidelights and transoms are also available.



Available in custom sizes to fit all projects.

## WINDOW FRAME OPTIONS

You'll find a 100 Series window to match any project from commercial to residential, no matter the location. And with uniform sight lines, it's easy to specify 100 Series products for the entire project. Additionally, 100 Series window frame options offer the flexibility needed to complete everything from new construction to home improvement, and they're available in 1/8" (3) increments when custom sizing is required.

- 3 1/8" (79) uniform sight lines allow for easy specification
- An extension jamb attachment flange is available for easy application of extension jambs on the job site.
- Single-hung drywall pass-through windows have an upper sash that can be easily removed on the job site after the window is installed.\* With both sash removed, drywall can easily fit through upper-floor windows.

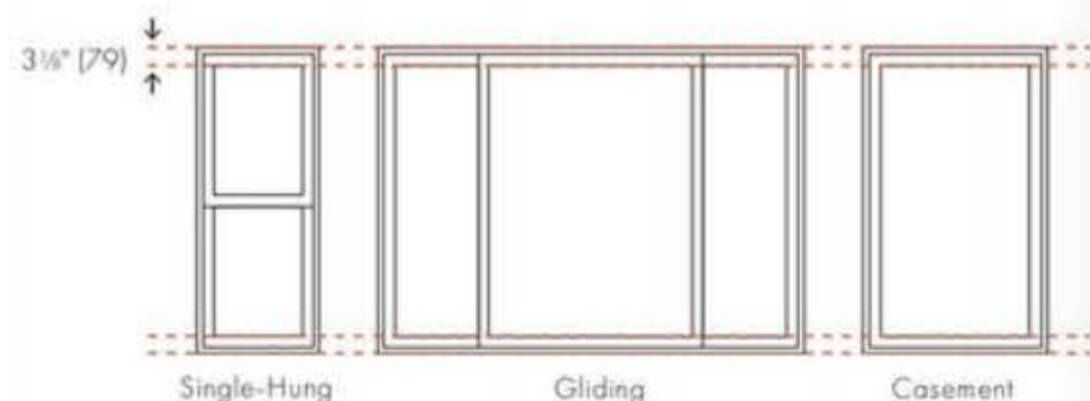

### NEW CONSTRUCTION WINDOW FRAME OPTIONS

#### 1 3/8" (35) Flange Setback

- Designed for new construction
- Integral installation flange makes installation into a new opening easy and helps make sure the windows and doors are weathertight

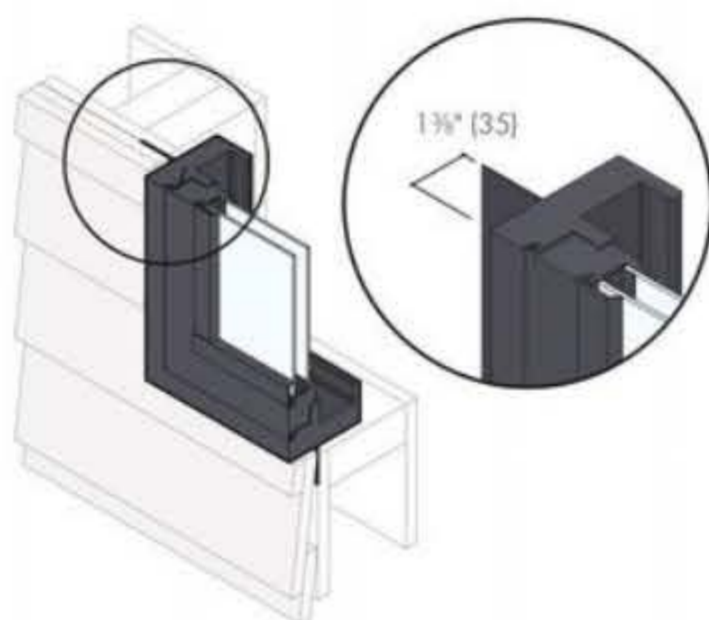

#### 1" (25) Flange Setback With Stucco Key

- For new construction with stucco exteriors
- Stucco key eliminates gaps that can result from the natural contraction of the exterior stucco
- Integral installation flange makes installation into a new opening easy and helps make sure the windows and doors are weathertight

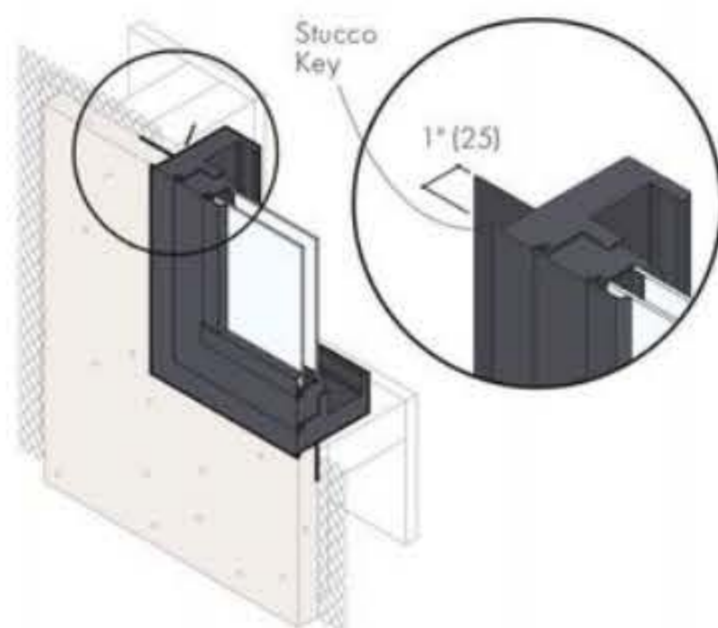

\*Optional drywall pass-through window is not available with flush fin frame. Dimensions in parentheses are in millimeters.

### REPLACEMENT WINDOW FRAME OPTIONS

#### No Flange Frame

- Allows for full removal of an existing window when the existing frame is rotten or damaged
- Installed into the existing rough opening
- Includes pre-drilled, through-the-jamb installation holes and installation screws to save you time

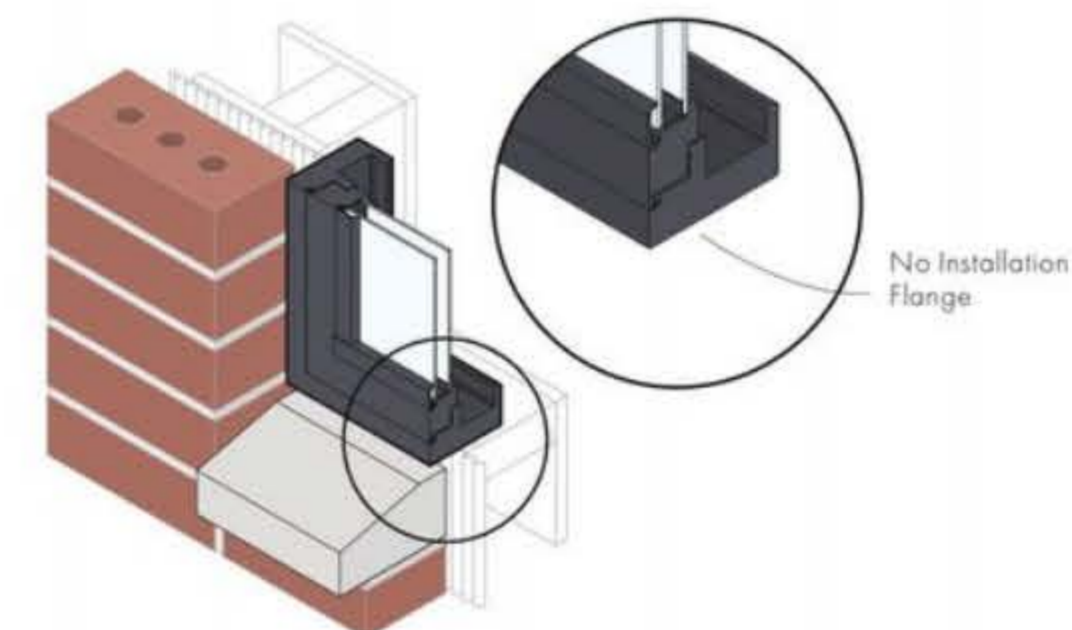

#### Insert Frame

- Provides fast and easy window replacement when installing into an existing window frame
- Saves time and money with minimal disruption to the interior or exterior trim
- Exterior accessory kerf for convenient finishing of the window
- Installation accessories include an exterior sill extender to fill the gap at the sill (shown) in addition to exterior frame extender for sides and a head expander

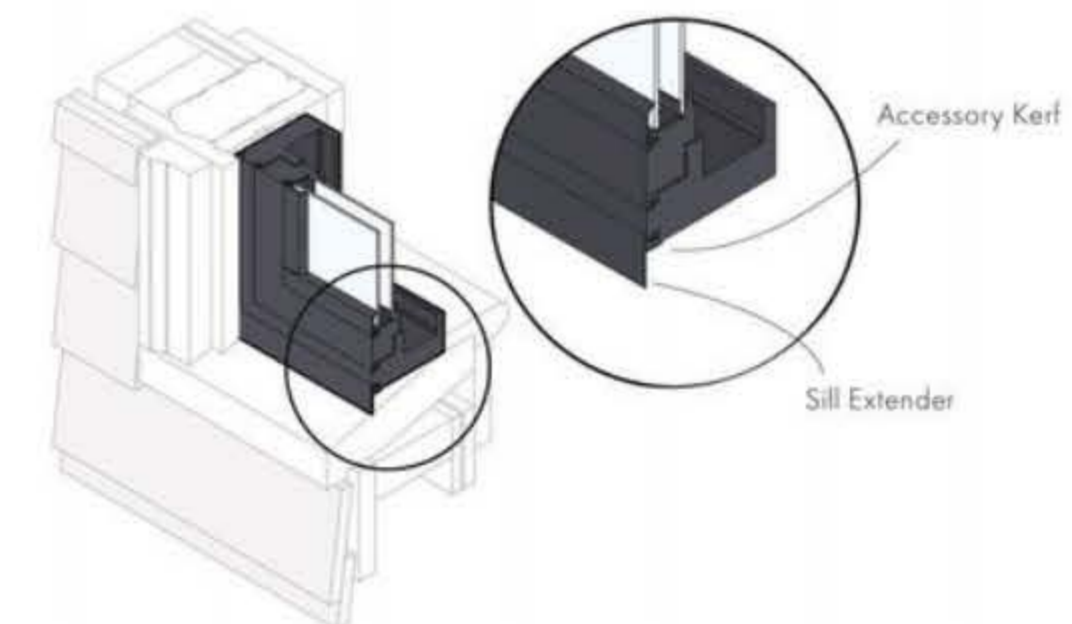

#### Flush Fin Frame **NEW!**

- Allows for easy replacement in stucco applications when installing over an existing aluminum window frame
- Minimizes disruption to the home's stucco exterior
- Flush fin has grooves at 1/2" (13) and 1" (25) for easy trimming
- Flat and curved interior trim is available to cover the existing window frame
- Available in select Southwestern states including Arizona, California, Nevada, New Mexico and Utah. Limited configuration availability. See your Andersen supplier for more information.

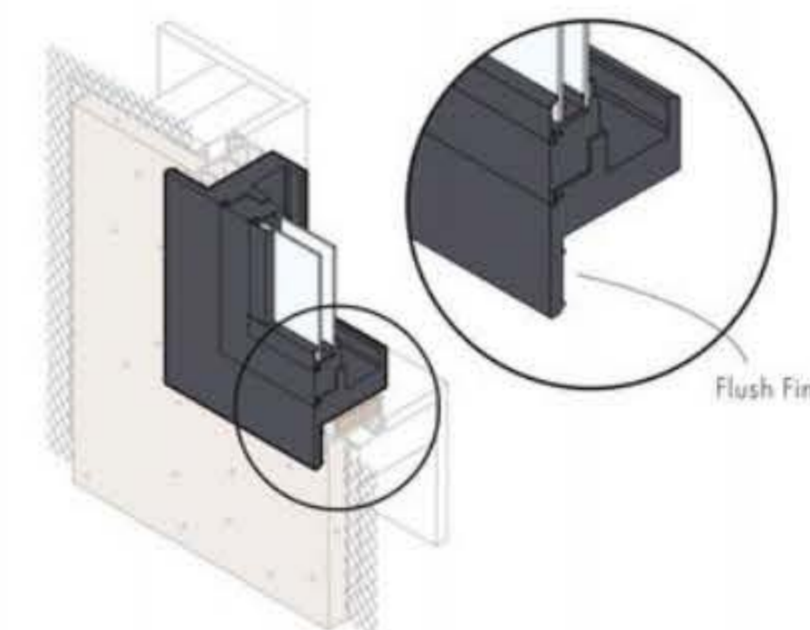

Dimensions in parentheses are in millimeters.



## EXTERIORS & INTERIORS

100 Series windows and patio doors come in five exterior colors, including dark bronze and black – colors that are darker and richer than those of most vinyl windows. The interiors feature a premium matte finish for an attractive appearance.

### EXTERIOR COLORS



### INTERIOR COLORS



\*Products with Sandtone, dark bronze and black interiors have matching exteriors. Printing limitations prevent exact duplication of colors. See your Andersen supplier for actual color samples.



## HARDWARE

### Casement & Awning Windows



Antique Brass | Black | Dark Bronze  
Sandtone | **Satin Nickel** | White

Folding handles avoid interference with window treatments.

### Single-Hung & Gliding Windows



Standard Lock

Optional Lift/Pull

Hardware color matches the window's interior. Shown in white. Lock automatically engages when window is closed.



Optional Metal Slim Line Lock

Antique Brass | Black | **Dark Bronze**  
Sandtone | **Satin Nickel** | White

lock automatically engages when window is closed.

### WINDOW HARDWARE FINISHES



Bold name denotes color or finish shown.

\*Available for exterior handle only. Printing limitation prevent exact replication of colors and finishes. See your Andersen supplier for actual color and finish samples.

### Gliding Patio Doors



#### TULSA

Standard Handle

Exterior handle color matches the door's exterior. Interior handle color matches the door's interior. Exterior handle shown in dark bronze. Interior handle shown in white.

Optional auxiliary foot lock is available. See [page 100](#).

### TULSA HARDWARE FINISHES



#### AFTON

Optional Handle

Antique Brass  
Black  
Bright Brass  
**Satin Nickel**

Optional auxiliary foot lock is available. See [page 100](#). Bold name denotes color or finish shown.



### AFTON HARDWARE FINISHES



# 100 SERIES UNIQUELY ANDERSEN, INCREDIBLY STRONG



## GLASS

Andersen has the glass you need to get the performance you want, with options for every climate, project and customer.

Check with your supplier for the selections that meet ENERGY STAR® requirements in your area.

GLASS		ENERGY		LIGHT	
		U-Factor <small>How well a product prevents heat from escaping.</small>	Solar Heat Gain Coefficient <small>How well a product blocks heat caused by sunlight.</small>	Visible Light Transmittance <small>How much visible light comes through a product.</small>	UV Protection <small>How well a product blocks ultraviolet rays.</small>
<b>SmartSun™</b>	Thermal control similar to tinted glass, with visible light transmittance similar to Low-E glass.	● ● ● ● ○	● ● ● ● ●	● ● ● ● ○	● ● ● ● ●
<b>SmartSun with HeatLock® Coating</b>	Applied to the room-side surface, it reflects heat back into the home and improves U-Factor values.	● ● ● ● ●	● ● ● ● ●	● ● ● ● ○	● ● ● ● ●
<b>Low-E</b>	Outstanding overall performance for climates where both heating and cooling costs are a concern.	● ● ● ● ○	● ● ● ● ○	● ● ● ● ○	● ● ● ● ○
<b>Low-E with HeatLock Coating</b>	Applied to the room-side surface, it reflects heat back into the home and improves U-Factor values.	● ● ● ● ●	● ● ● ● ○	● ● ● ● ○	● ● ● ● ○
<b>Sun</b>	Outstanding thermal control in southern climates where less solar heat gain is desired.	● ● ● ● ○	● ● ● ● ●	● ○ ○ ○ ○	● ● ● ● ○
<b>PassiveSun®</b>	Ideal for northern, passive solar construction applications where solar heat gain is desired.	● ● ● ● ○	● ○ ○ ○ ○	● ● ● ● ●	● ● ○ ○ ○
<b>PassiveSun with HeatLock Coating</b>	Applied to the room-side surface, it reflects heat back into the home and improves U-Factor values.	● ● ● ● ●	● ○ ○ ○ ○	● ● ● ● ●	● ● ○ ○ ○
<b>Clear Dual-Pane</b>	High visibility, with basic thermal performance.	● ○ ○ ○ ○	○ ○ ○ ○ ○	● ● ● ● ●	○ ○ ○ ○ ○

Center of glass performance only. Ratings based on glass options as of August 2023. Visit [andersenwindows.com/energy](https://andersenwindows.com/energy) for ENERGY STAR map and NFRC total unit performance data.

### HEATLOCK TECHNOLOGY

Applied to the room-side glass surface, HeatLock coating reflects heat back into the home for improved performance.

### TIME-SAVING FILM

We protect our products during delivery and construction with translucent film on the glass that peels away for a virtually spotless window.

For more details on our glass options, visit [andersenwindows.com/glass](https://andersenwindows.com/glass).



### ADDITIONAL GLASS OPTIONS

**Tempered safety glass** is standard on patio doors and required for larger window sizes.

**Patterned glass** lets in light while obscuring vision and adds a unique, decorative touch.



Cascade Fern Obscure



Reed Satin Etch

Cascade and Reed patterns are only available in a vertical orientation.

### GLASS SPACER OPTIONS

In addition to stainless steel glass spacers, black glass spacers are available as another way to customize project designs and achieve a contemporary style. Black glass spacers can blend in with the color of the window or door for a sleek design or serve as a shadow line.

Add full divided light grilles and the grille spacer bar between the glass will match.



Black Stainless Steel

\*ENERGY STAR® is a registered trademark of the U.S. Environmental Protection Agency.

## GRILLES

Grilles for 100 Series windows and patio doors are available in a wide variety of patterns to complement virtually any style of home. Plus, they have options for easy cleaning and architectural authenticity many vinyl windows can't match.



Finelight grilles-between-the-glass



Finelight grilles-between-the-glass with permanent exterior



Permanent exterior and permanent interior with spacer



Permanent exterior and permanent interior without spacer

### FINELIGHT™ GRILLES-BETWEEN-THE-GLASS

Make glass easy to clean and have an elegant, sculpted profile. Choose a two-sided color scheme to match both the interior and exterior of the window or patio door. Also available with exterior grilles to provide architectural style and detail.

### FULL DIVIDED LIGHT

Permanently applied to the exterior and interior of the window, with a spacer between the glass.

### SIMULATED DIVIDED LIGHT

Permanently applied to the exterior and interior of the window, without a spacer between the glass.

#### Grille Bar Widths Actual width shown.

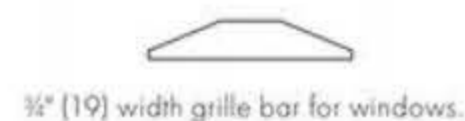

3/8" (19) width grille bar for windows.



1" (25) width grille bar for patio doors.



A 2 1/2" (57) width grille is available for most units to simulate a meeting rail or a multi-unit combination such as a transom over a window or patio door.

#### Grille Patterns



Prairie A Colonial Modified Colonial Tall Fractional Short Fractional Specified Equal Light\* Custom

To see all of the standard patterns available for a specific window or door, refer to the detailed product sections in this product guide or contact your Andersen supplier.

## INSECT SCREENS



Insect screens for venting windows have a fiberglass screen mesh. Optional TruScene® insect screens are made with a micro-fine stainless steel mesh, providing more than 50% greater clarity than our conventional insect screens. Insect screen frames for casement and awning windows are color matched to the product interior and for single-hung and gliding windows are matched to the product exterior.

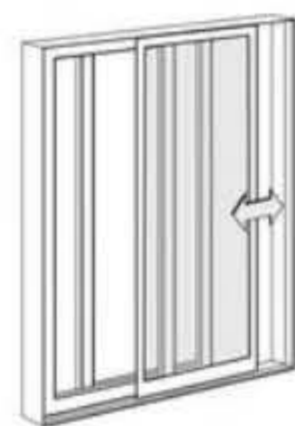

Gliding insect screens for two-panel gliding patio doors have a fiberglass screen mesh. Insect screen frames for doors are color matched to the product exterior.

\*Specify number of same-size rectangles across or down. Dimensions in parentheses are in millimeters.

BUILDERS AGREE  
**WINDOWS MADE OF ANDERSEN'S FIBREX® COMPOSITE MATERIAL OUTPERFORM VINYL WINDOWS\***

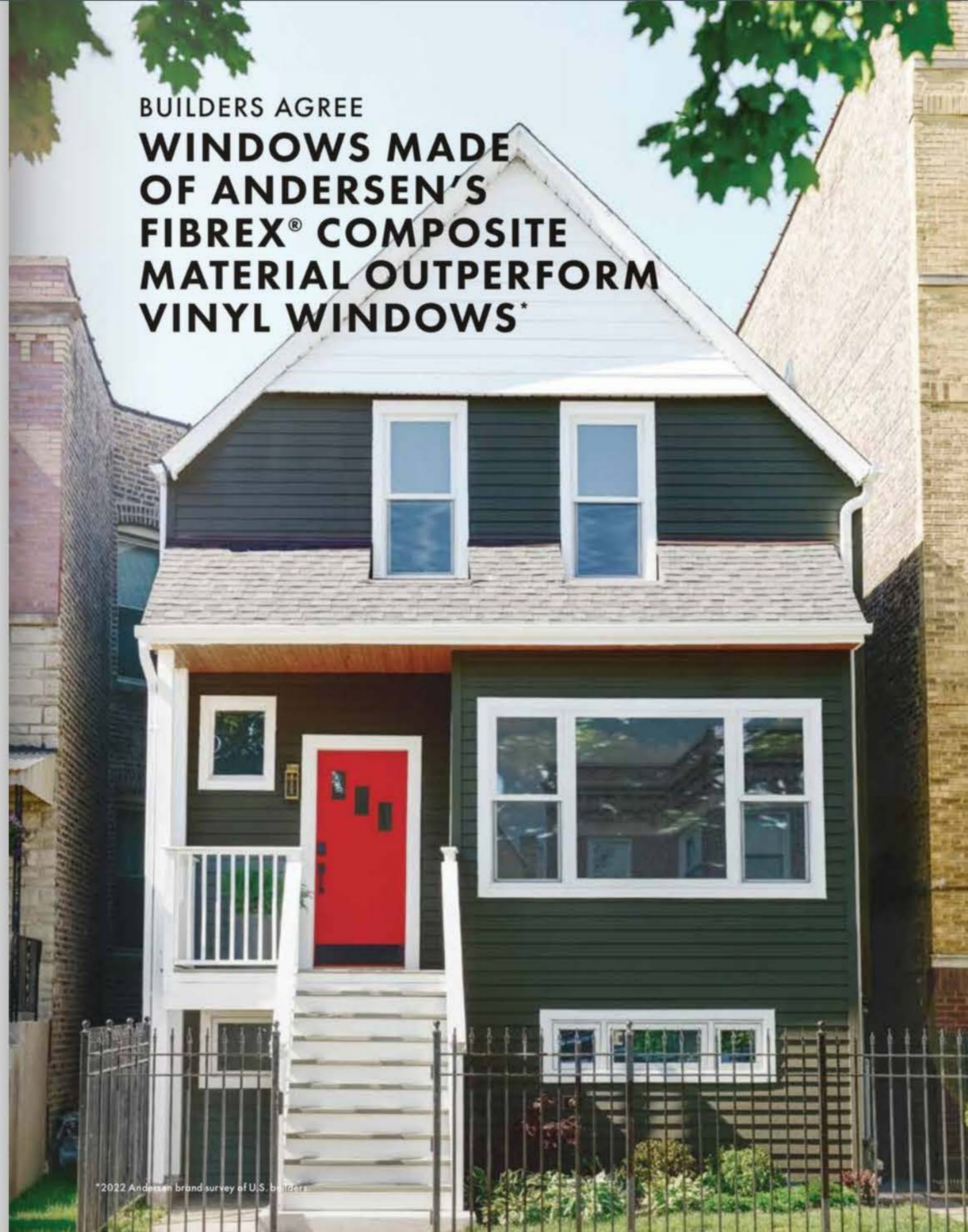

\*2022 Andersen brand survey of U.S. builders

# HINGED PATIO DOORS

## FEATURES

### HINGED PATIO DOORS

#### FRAME & PANEL

**A** Select wood components are kiln dried and treated with water/insect repellent and preservative. Interior wood surfaces are available in pine, mixed grain Douglas fir, cherry, hickory, mahogany\*, maple, oak, walnut, alder or vertical grain Douglas fir. Interior surfaces are available unfinished or factory primed. Optional factory-applied finishes are available in a variety of stains and paints.

**B** Wood components are fitted with aluminum extrusions on the exterior. 50 exterior colors that meet AAMA 2604 and 2605 specifications are available, as well as custom colors. Also available is a selection of seven exterior anodized options.

**C** The frame perimeter consists of a high-quality foam-filled weatherstrip.

Inswing and outswing doors receive a factory-applied vinyl installation flange with drip cap. Some inswing patio doors require an adjustable metal installation flange. Optional aluminum flanges and metal installation clips are available.

#### SILL

##### Drainage Sill for Inswing Patio Doors

**D** Premium grade aluminum inswing sill with an oak threshold. Sills have a built-in drainage channel that allows water to drain away from the interior of the door. A top plate is removable for easy channel cleaning. A polyurethane thermal barrier helps reduce heat loss. Available in clear anodized or dark bronze anodized finish, shown below.

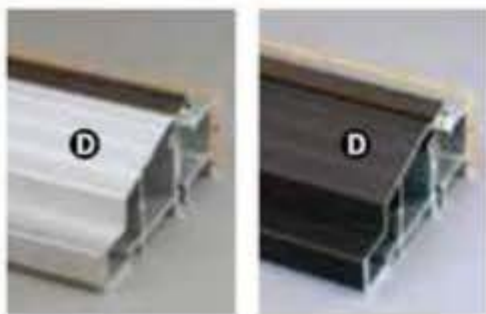

Drainage sills for inswing



Inswing Patio Door with Contemporary Panel

##### On-Floor Sill for Outswing Patio Doors

**E** Premium grade aluminum outswing sill with oak threshold. Outswing door sill is backed with a compression foam weatherstrip. Available in clear anodized or dark bronze anodized finish, shown below.

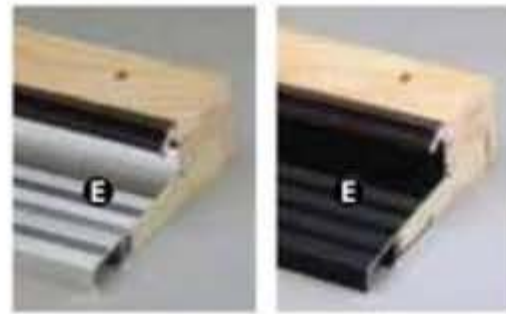

On-floor sills for outswing

##### Low-Threshold Sill

**F** Aluminum low threshold sill available for outswing doors and inswing doors. Available for inswing doors with jamb depths of 4 9/16" and 6 9/16". Low threshold design provides a smooth transition from interior to exterior and is wheelchair-accessible. A polyurethane thermal barrier helps reduce heat loss. Available in dark bronze anodized finish, shown below.

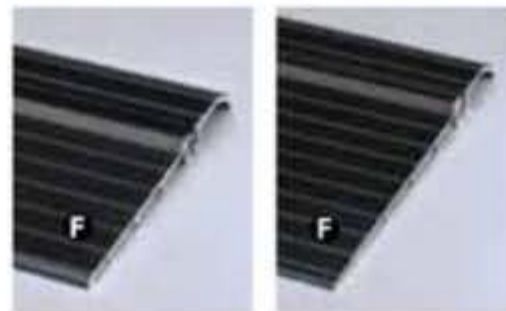

4 9/16" & 6 9/16" Low-threshold sills for inswing



4 9/16" Low-threshold sill for outswing

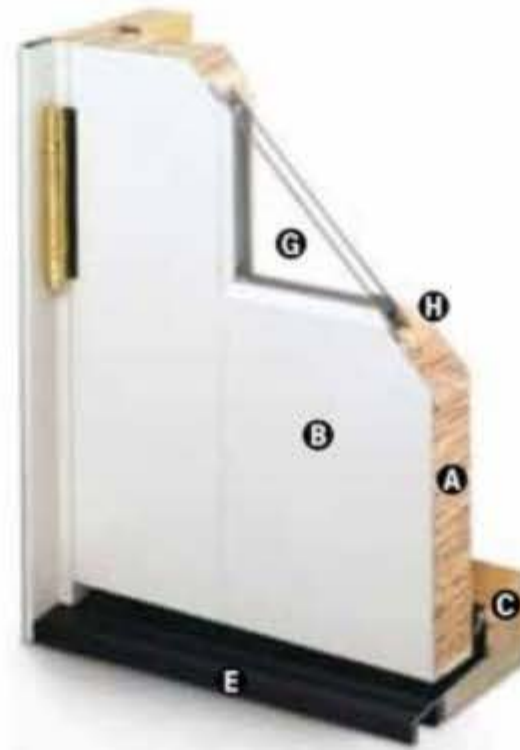

Outswing Patio Door with French Panel

#### GLASS

**G** High-Performance Low-E4® glass with a low-conductivity spacer. Triple-pane glass, tinted, clear dual-pane, high-altitude glass and other special glazing options are available.

**H** Glass is fixed in place from the interior with wood stops that can be removed for easy reglazing if necessary. Glass stops available in ovolo (colonial) and contemporary profiles.

**GLASS SPACERS available in black, white and stainless steel.**

#### HARDWARE

##### Multi-Point Locking System

Autolatch® stainless steel multi-point locking system locks the panel in three locations to provide a secure, weather-resistant entry system. Some door heights lock the panel in four locations.

##### Hinges



Heavy-duty commercial grade hinges are available in finishes of antique brass, black, bright brass, satin chrome, pewter, gold dust, oil rubbed bronze, bright chrome, stainless steel, and white to go with your handle set. Hinges are complete with matching screws. An innovative hinge shimming system allows for minor adjustments.

**Satin Chrome, Gold Dust and Bright Chrome DISCONTINUED**

\*Actual wood species is either Sapele or Sipo, both non-endangered species grown in Africa, with color and characteristics similar to Central American mahoganies.

## ACCESSORIES Sold Separately

### HINGED PATIO DOORS

#### HARDWARE

##### Construction Handle



Temporary construction handle is sent with all hinged patio doors. This handle allows operation during the construction phase, protecting finished hardware from damage or jobsite theft.

##### Hardware Options

Additional hardware options such as exterior keyed locks and more are also available. Contact your Andersen supplier.

#### SENSORS

##### Yale® Assure Lock®

Monitor, lock and unlock from anywhere with the Yale Assure Lock. The sleek keyless lock includes Bluetooth® technology for key-free unlocking and is compatible with Z-Wave® for integration with a wide range of smart home platforms. Available on select hinged doors, see your Andersen supplier for details.

##### **VeriLock & Open/Closed Sensors DISCONTINUED**

detect whether the doors are locked or unlocked\* — a feature no other sensors can provide. Available in all hardware finishes.

##### Open/Closed Sensors

Wireless open/closed sensors are available in four colors.

See [page 27](#) for Smart Home options.

#### INSECT SCREENS

##### Retractable Insect Screens



Concealed, retractable insect screen has charcoal fiberglass screen mesh. Available for inswing single or double door units. Insect screen rolls out when needed and retracts into concealed housing when not in use. Available in 50 exterior colors.

Retractable insect screens for outswing doors are field applied to the interior of the door. Available in five colors including white, almond, desert sand, bronze and black.

##### Hinged Insect Screens for Inswing Patio Doors

Charcoal fiberglass screen mesh fits into an aluminum frame in 50 exterior colors. Provided with a black lockable latch and automatic closer for smooth operation. Available in single or multiple door units. Aluminum screen mesh is also available.

##### Top-Hung Gliding Insect Screens for Inswing Center Post Patio Doors

Charcoal fiberglass screen mesh fits into an aluminum frame available in 50 exterior colors. Aluminum screen mesh is also available.

#### PRIVACY OPTIONS

##### Blinds-Between-the-Glass



A 5/8" aluminum slot blind mounted between two panes of insulated glass in a dust-free environment. Available in white, tan and almond. Blinds are magnetically controlled and can be tilted or raised and lowered with one cord.\*\* Not available on arch patio doors.

#### GRILLES

##### Full Divided Light

Permanent interior and exterior grilles with grille spacer bars between two panes of glass. Available in 5/8", 7/8", 1 1/8", 1 1/2", or 2 1/4" widths and ovolo or contemporary profile. Ovolo profile shown below, not all widths are pictured.

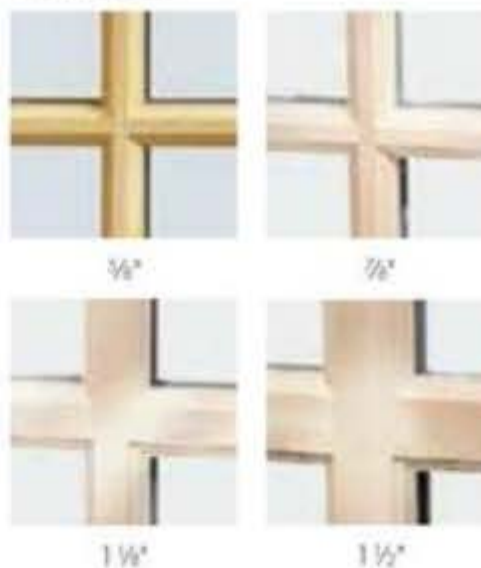

##### Simulated Divided Light

Permanent exterior and interior grilles without grille spacer bars. Available in 5/8", 7/8", 1 1/8", 1 1/2", or 2 1/4" widths and ovolo or contemporary profile. Ovolo profile shown below, not all widths are pictured.



##### Finelight™ Grilles-Between-the-Glass

Available in 5/8" flat or 1" contoured aluminum profiles. Two-tone colors of pebble tan/colony white, sierra bronze/colony white or forest green/colony white are available on the 1" profile.



##### Removable Interior Wood Grilles

Removable interior wood grilles are available in a 7/8" width and ovolo or contemporary profiles. Optional surround for removable grille and permanent exterior grilles also available. Ovolo profile shown below.



See [page 22](#) for more information on grilles.

\*When properly configured and maintained with a professionally installed security system and/or self-monitoring system compatible with Honeywell® 5800 controls. See your Andersen supplier for more information.

\*\*Not all sizes are retractable. See your local Andersen supplier for details.

## Hinged Outswing Patio Doors

### Hinged Outswing Patio Door

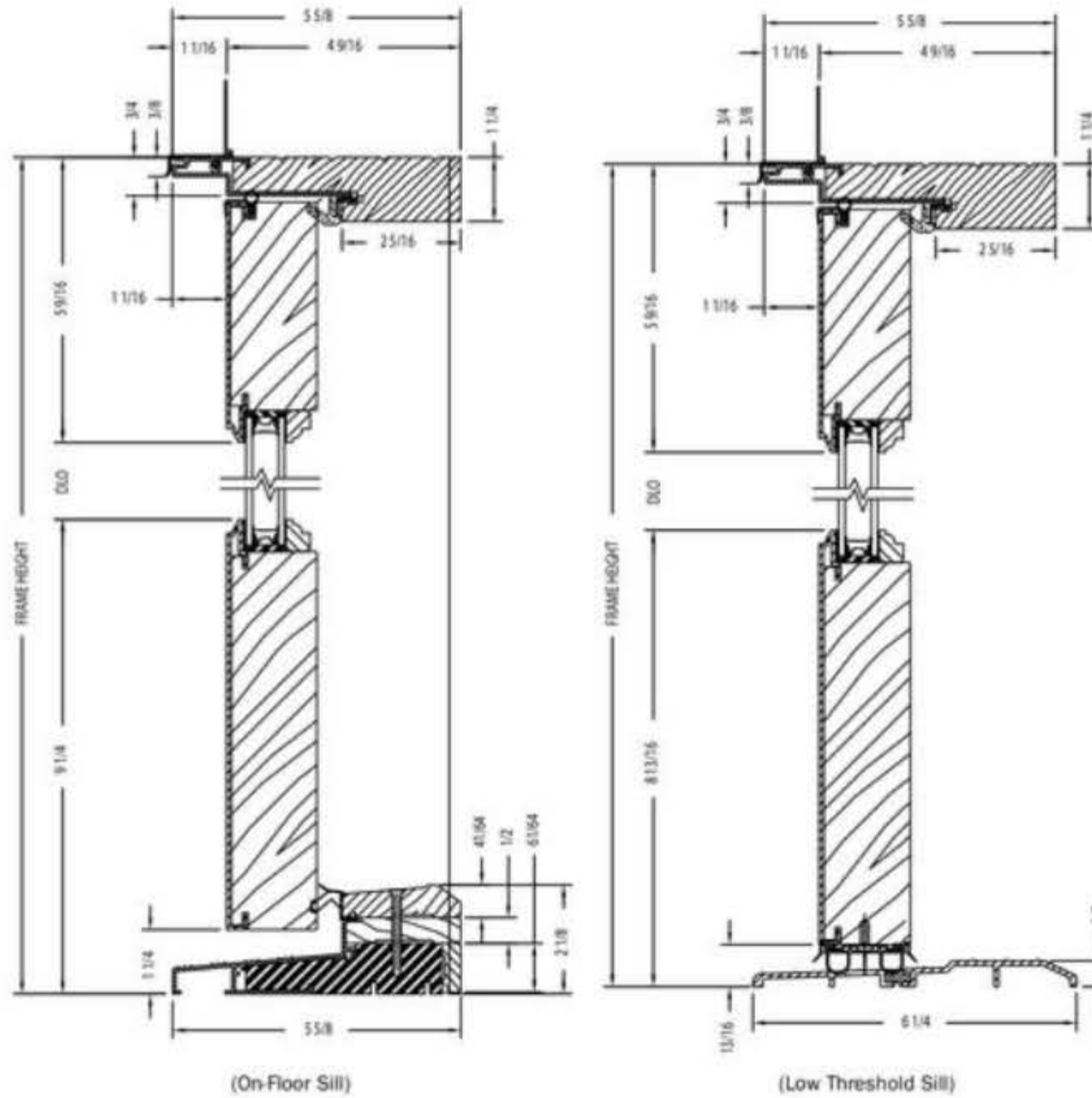

Vertical Section

### Astragal

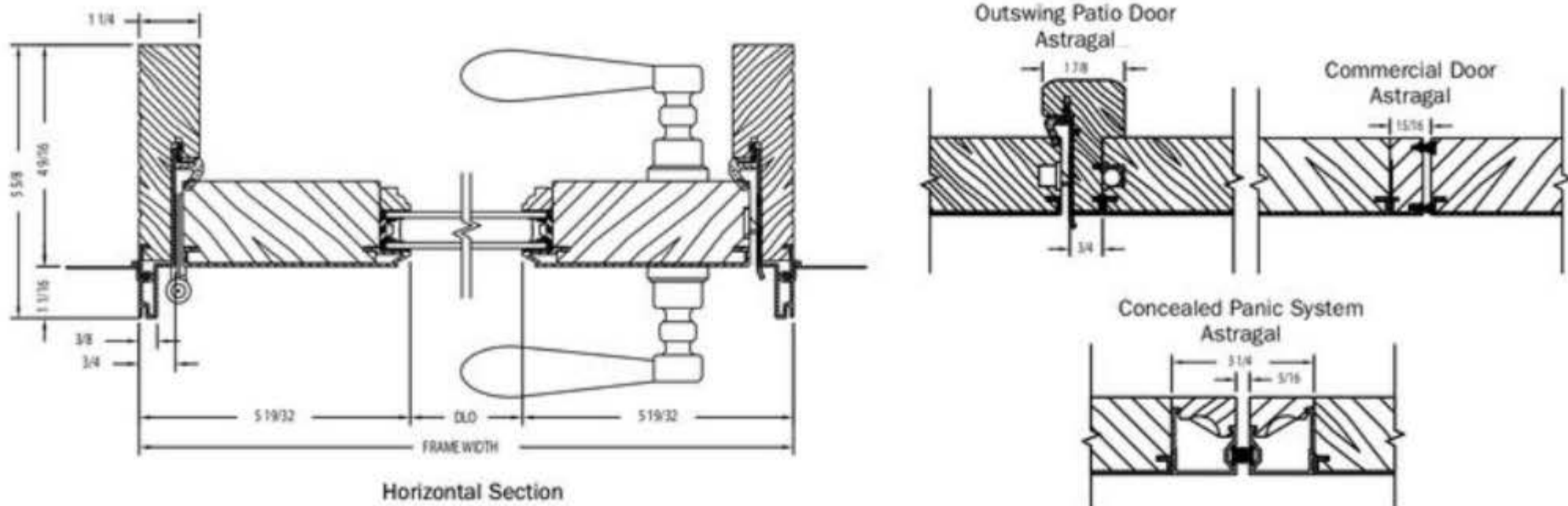

Horizontal Section

Shown with ovolo (colonial) glass stops.  
French panel shown, also available with a contemporary panel.

PROPER INSTALLATION AND MAINTENANCE OF E-SERIES PRODUCTS IS ESSENTIAL TO ATTAIN OPTIMUM PERFORMANCE AND OPERATION. WRITTEN INSTALLATION INSTRUCTIONS THAT PROVIDE GUIDELINES FOR PROPER INSTALLATION ARE AVAILABLE BY VISITING [ANDERSENWINDOWS.COM](http://ANDERSENWINDOWS.COM). CUSTOM SIZES ARE AVAILABLE. CONTACT YOUR LOCAL SUPPLIER FOR MORE INFORMATION. DRAWINGS ARE NOT TO SCALE.

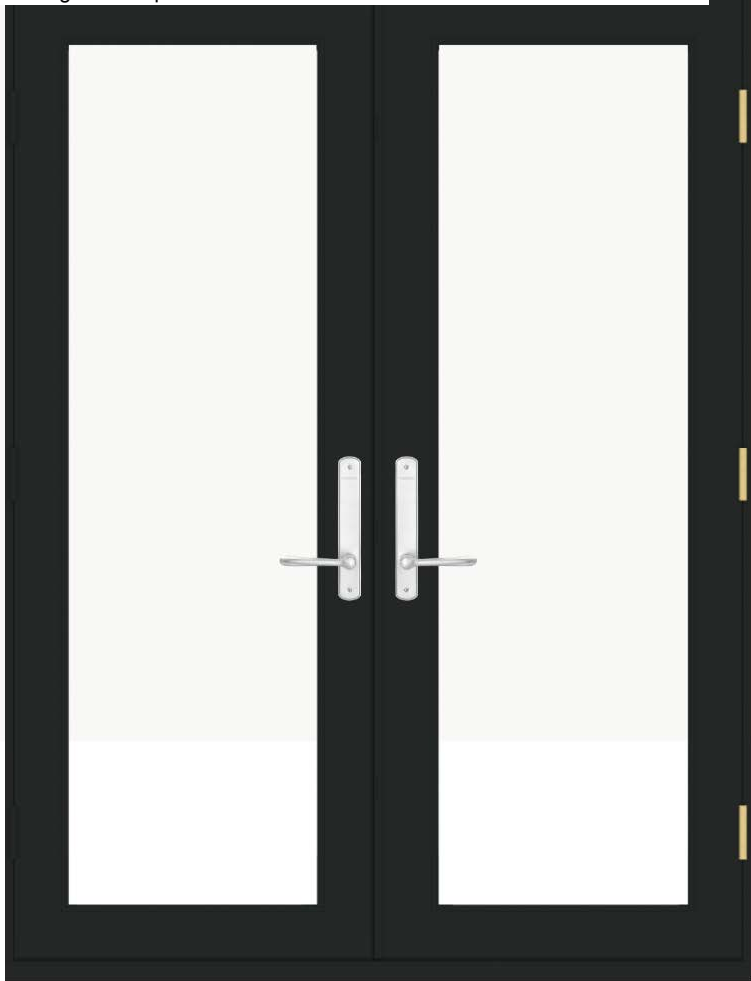

INTERIOR

EXTERIOR



February 18, 2025

708 Pallister St.,  
Detroit, MI 48202

RE: 708 Pallister Exterior Renovations

### Scope of Work

1. Demolish (2) new construction dormer roofs (east and west dormers)
2. Rebuild (2) dormer roofs as hipped roofs with wide eaves (depth to match existing)
  - a. Eaves to be sloped to match existing dormer
  - b. Eaves and fascia to be wood, painted (to match existing)
3. (2) installed sliding windows in new dormers to be replaced with 8-lite, simulated divided lite fibrex windows casement units, painted black (Anderson 100 series) (style to match existing dormer)
4. Install 8-lite, simulated divided lite fibrex window casement unit (Anderson 100 series) (style to match existing dormer) in east side dormer; paint window black
  - a. Drywall interior face of window
5. Remove composite shake siding from all dormers
6. Install wood shake siding and trim at all dormers; paint HDC approved color C:4 "Yellowish White" with Black trim
7. At new east elevation forward ground floor window, remove installed inset trim; replace with wood trim atop/pronounced from siding, to match existing window trim; trim size (WxD) to match existing
  - a. At new east elevation forward ground floor window, remove 'belt band' wood trim above window as required (where window extends into band), replace with continuous trim piece to match previously existing style; paint black
8. Replace east elevation second floor sliding window with 6-lite, simulated divided lite aluminum-clad wood awning window unit, painted black (Anderson 400 series); lite style to match previously existing window
9. At east elevation, remove and reset (2) basement glass block windows
  - a. Glass block to be set in same plane as previously existing basement windows
  - b. Install window screen over each window, to match previously existing





10. Replace rear elevation ground floor sliding window with 12-lite, simulated divided lite aluminum-clad wood single-hung window unit, painted black (Anderson 400 series) (to match previously existing window)
11. Replace installed french door at rear elevation with aluminum-clad wood french door with 2/1 simulated divided lite pattern, painted black (to match previously existing windows at same location) (Anderson E series)
12. Install 3rd wood column at front porch, paint to match others already installed
13. Install 36" wood railing at front porch
14. Install "Trex Transcend Series" composite deck boards and 36" railing at rear deck
15. Install simulated divided lites into newly installed windows, lite style to match previously existing windows (see architectural drawings)
16. HVAC unit installed at west elevation: intended to remain
17. Brick veneer installed at front porch, painted to match existing: intended to remain

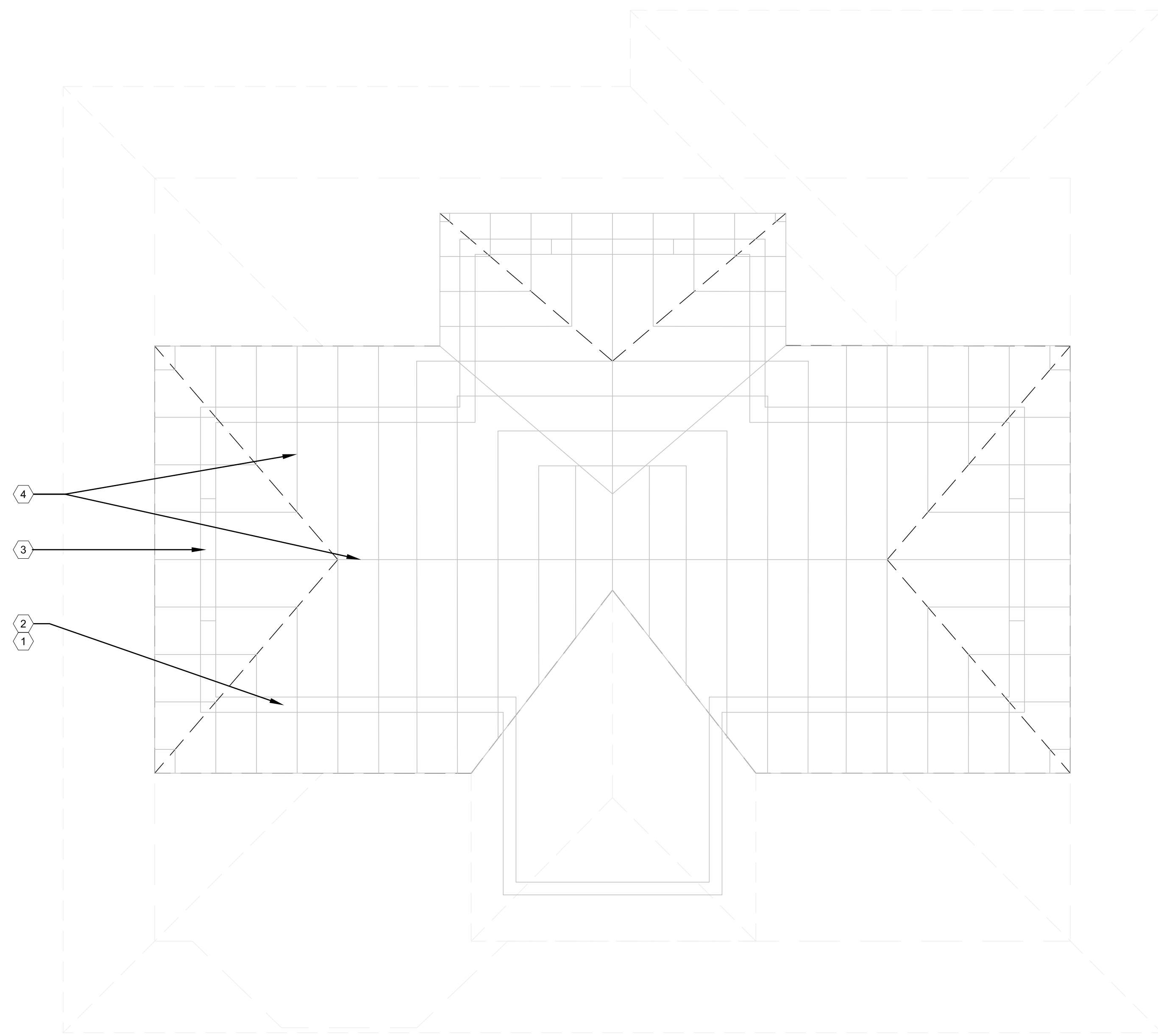

1 DORMER FRAMING PLAN  
 A4.1 SCALE: 1/2" = 1'-0"

- PLAN KEY NOTES:**  
 (TYPICAL THIS SHEET ONLY)
- 1 SISTER SIMILAR 2x
  - 2 2x6 WOOD STUD WALL
  - 3 2x6 DOUBLE HEADER
  - 4 2x6 RIDGE BEAM AND RAFTERS

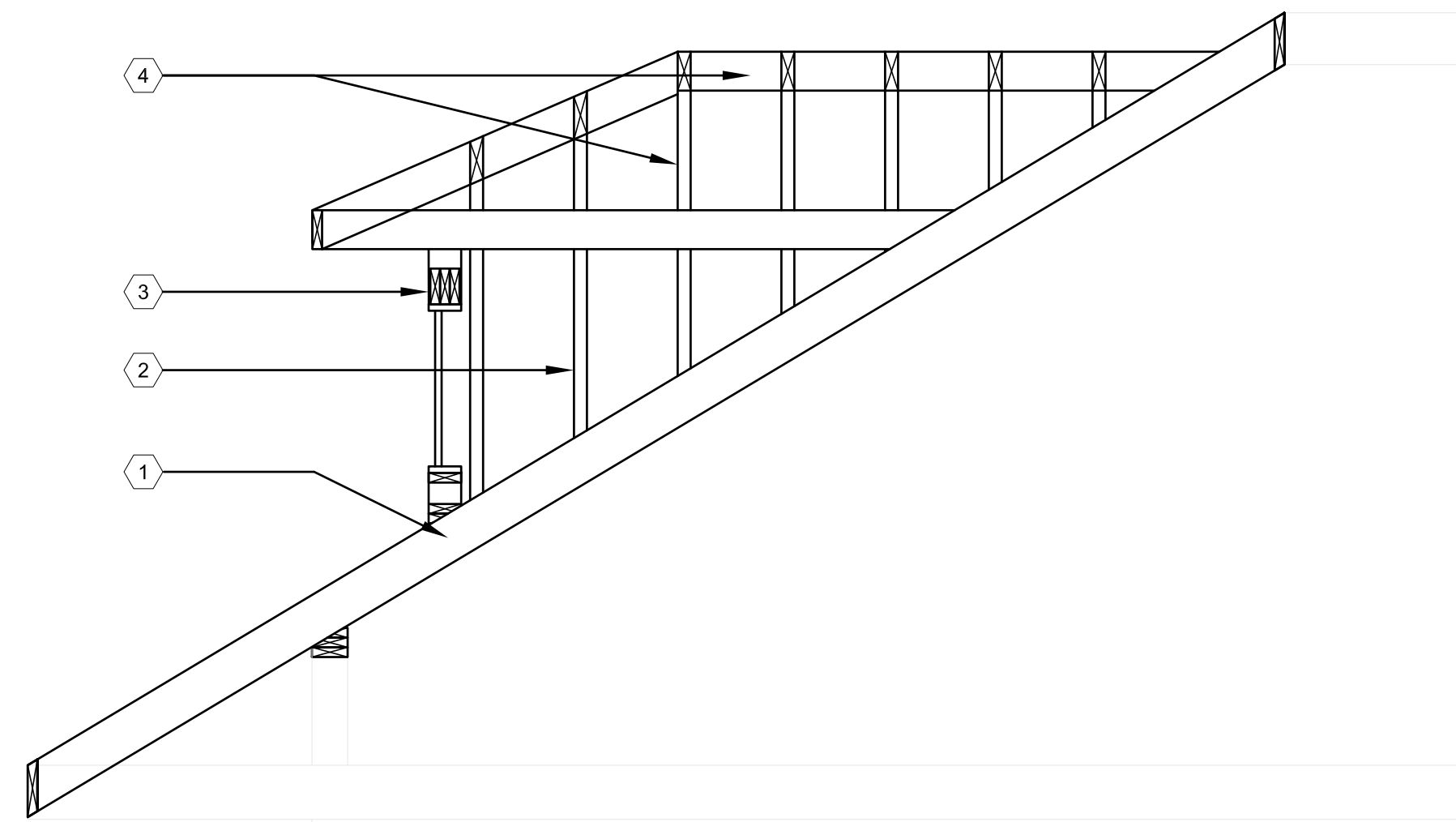

2 DORMER FRAMING SECTION  
 A4.1 SCALE: 1/2" = 1'-0"

ARCHITECT: <b>4545 architecture</b> 2761 E. JEFFERSON AVE STE 302 DETROIT, MI 48207 P. 313.454.4545 TIM.FLINTOFF@4545ARCHITECTURE.COM
CONSULTANT:
Project : <b>708 PALLISTER          HDC RENOVATION</b>
Issued for : <b>HDC SUBMIT 02/18/2025</b>
Drawn by : <b>ANJ</b> Check by : <b>TRF</b>
Sheet Title : <b>DORMER          FRAMING DETAILS</b>
Project No. : <b>2024001</b>
Sheet No. : <b>A4.1</b>

DO NOT SCALE DRAWINGS | ©2024 Timothy Flintoff Architect, PLLC

**Glass Block**

The Detroit Historic District Commission ("Commission") realizes that safety and energy concerns results in the desire to install glass block in basement window openings. While this treatment is not recommended, it may be acceptable provided certain conditions are met.

The installation of glass block in historic districts is work that is regulated by the City of Detroit's Historic District Ordinance No. 161-H. Any proposal for the installation of glass block in a historic district shall meet the following applicable conditions:

- A. The glass block shall be located at the same plane as the existing historic window, set back from the face of the building wall.
- B. The glass block shall be covered with the historic screen placed back in the window or with a new screen.
- C. Glass block will only be permitted in basement window openings.
- D. Openings with glass block that are on the front or visible from a side street shall be screened with foundation plantings that cover the windows.
- E. All glass block installations require a permit and Commission approval
- F. See the drawing below for more information.

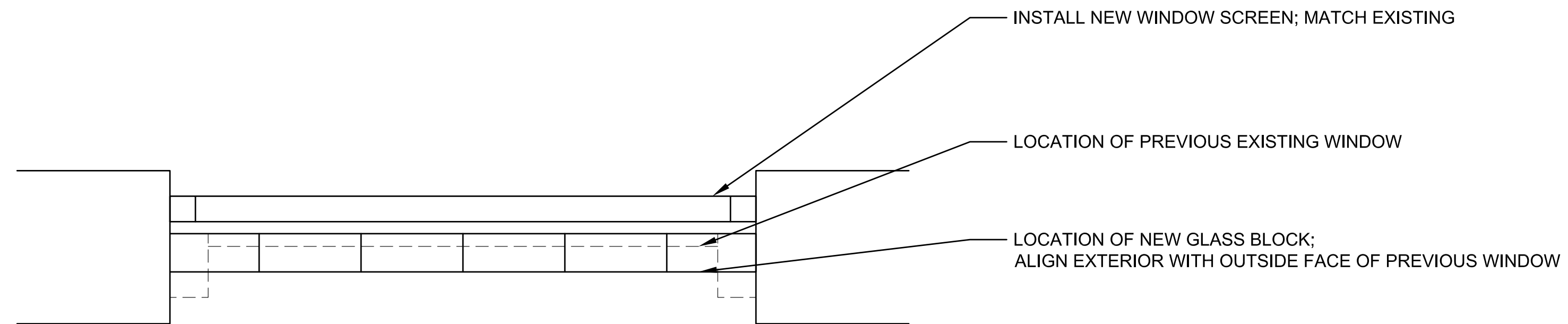
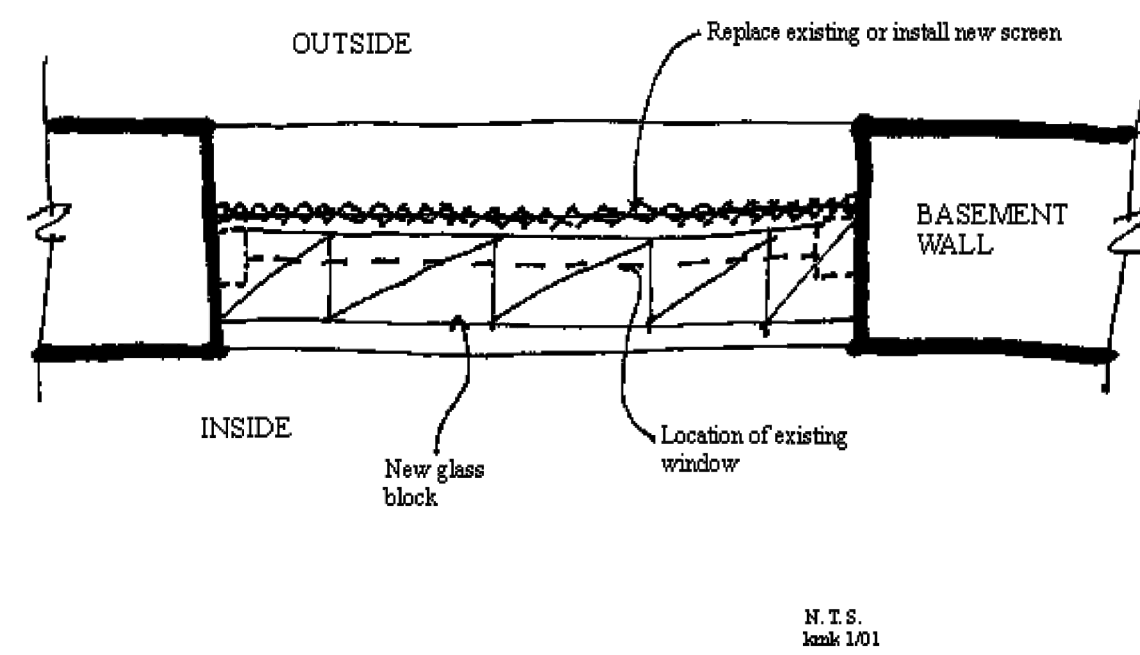

**1 GLASS BLOCK WINDOW DETAIL**  
SCALE: 1-1/2" = 1'-0"

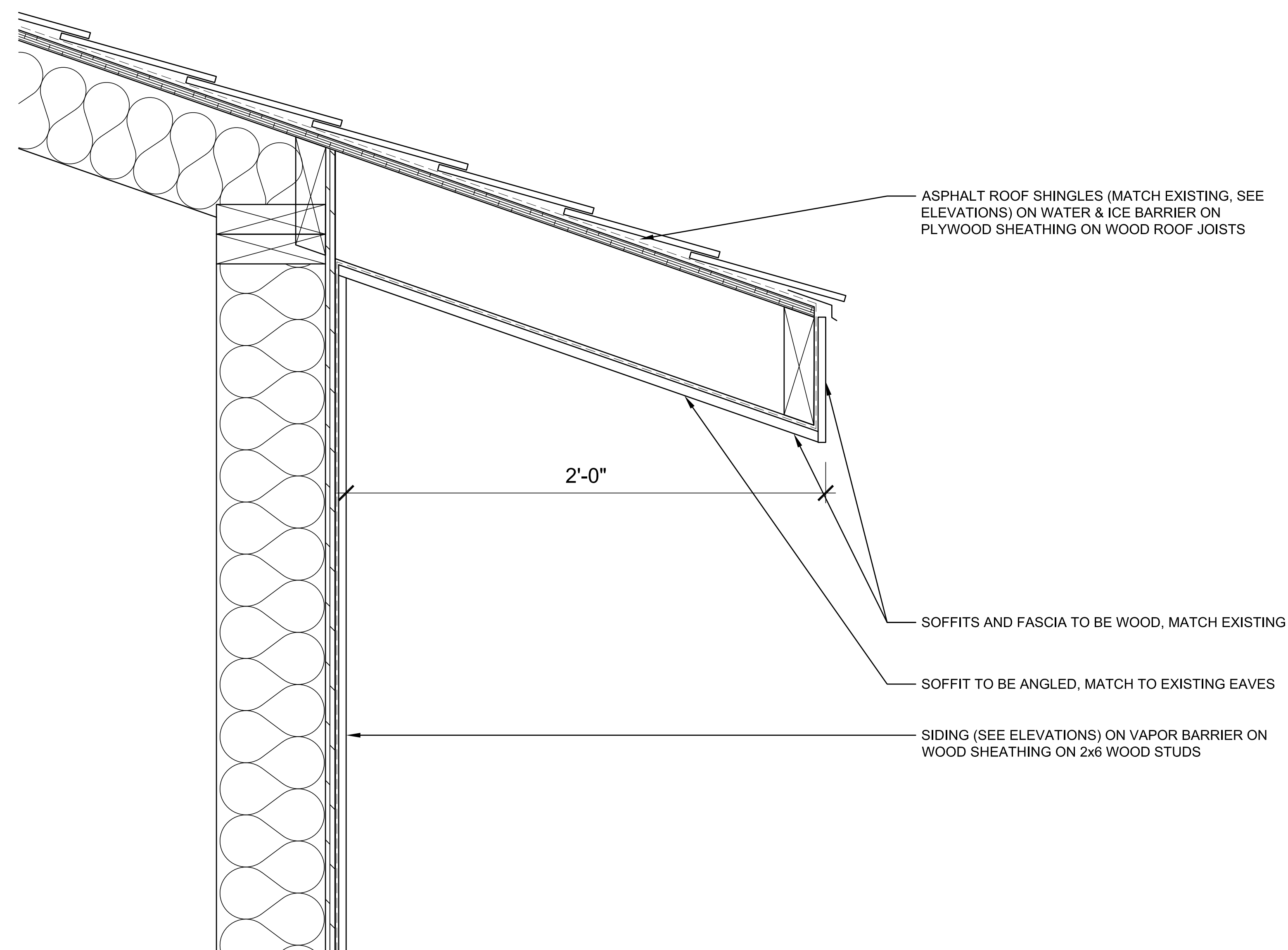

**2 DORMER SOFFIT DETAIL**  
SCALE: 3" = 1'-0"

ARCHITECT: <b>4545 architecture</b> 2761 E. JEFFERSON AVE STE 302 DETROIT, MI 48207 P. 313.454.4545 TIM.FLINTOFF@4545ARCHITECTURE.COM
CONSULTANT:
Project : <b>708 PALLISTER                  HDC RENOVATION</b>
Issued for : <b>HDC SUBMIT 02/18/2025</b>
Drawn by : <b>ANJ</b> Check by : <b>TRF</b>
Sheet Title : <b>DETAIL                  DRAWINGS</b>
Project No. : <b>2024001</b>
Sheet No. : <b>A5.1</b>

DO NOT SCALE DRAWINGS | ©2024 Timothy Flintoff Architect, PLLC

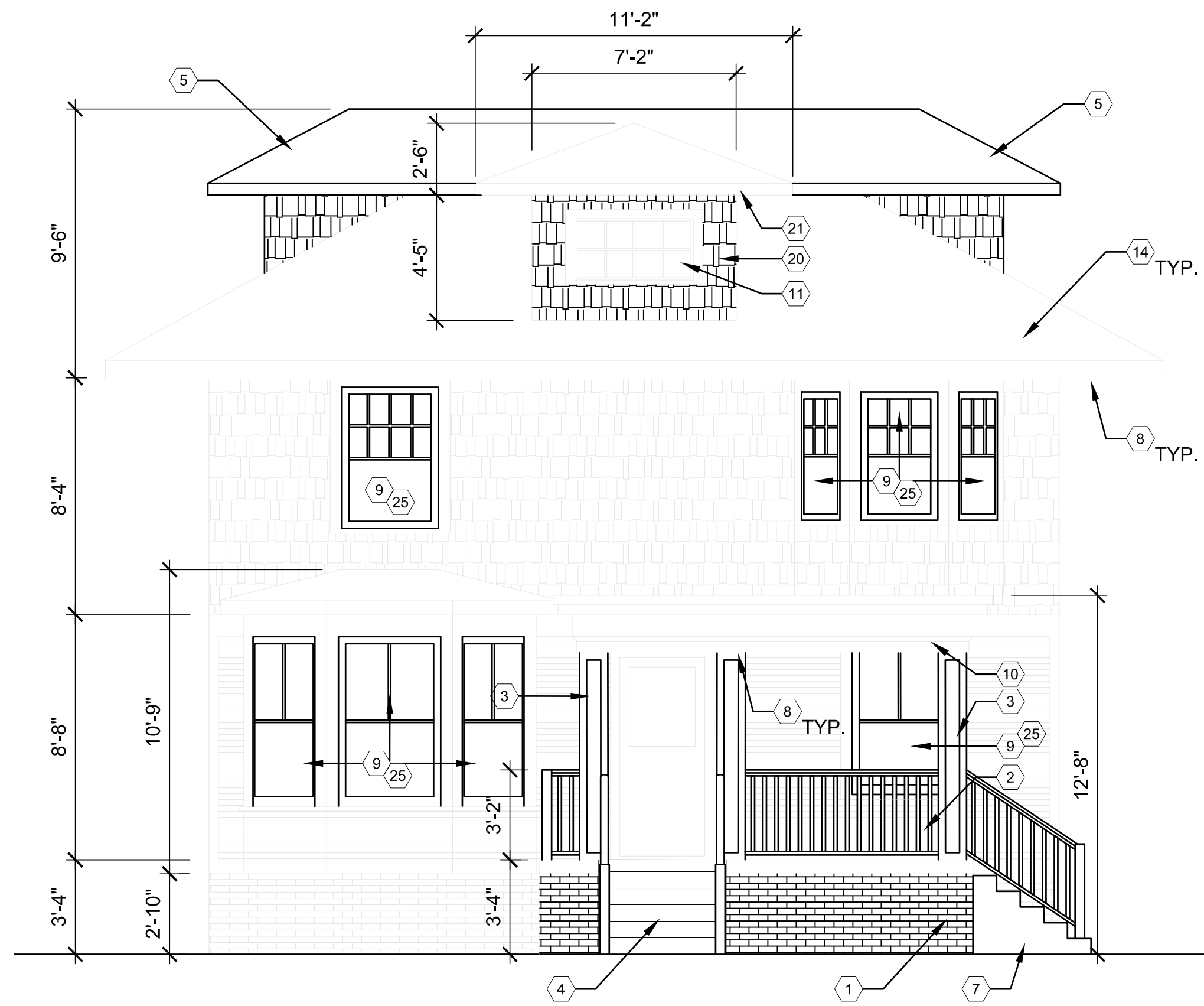

**1 SOUTH ELEVATION**  
SCALE: 1/4" = 1'-0"

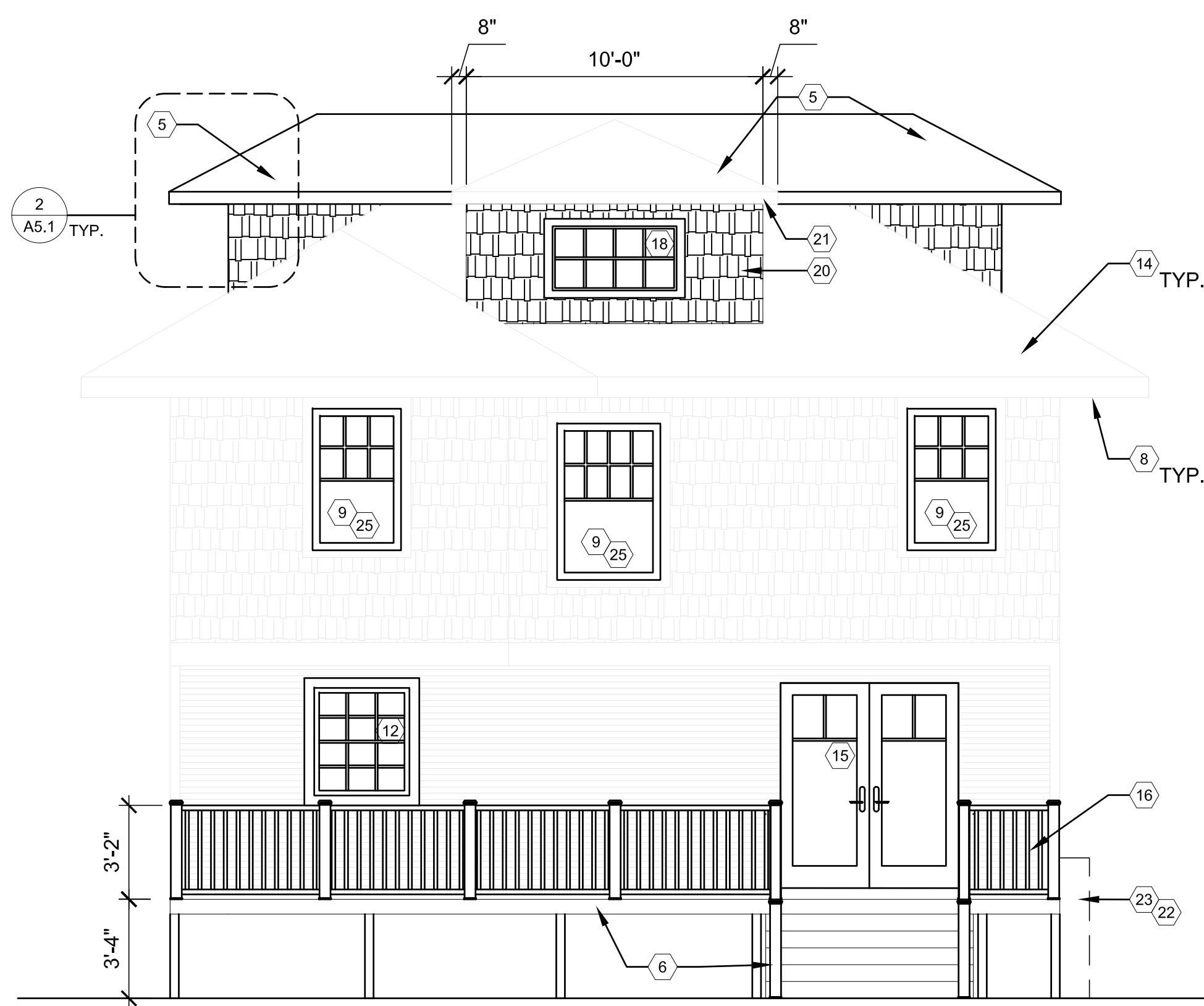

**2 NORTH ELEVATION**  
SCALE: 1/4" = 1'-0"

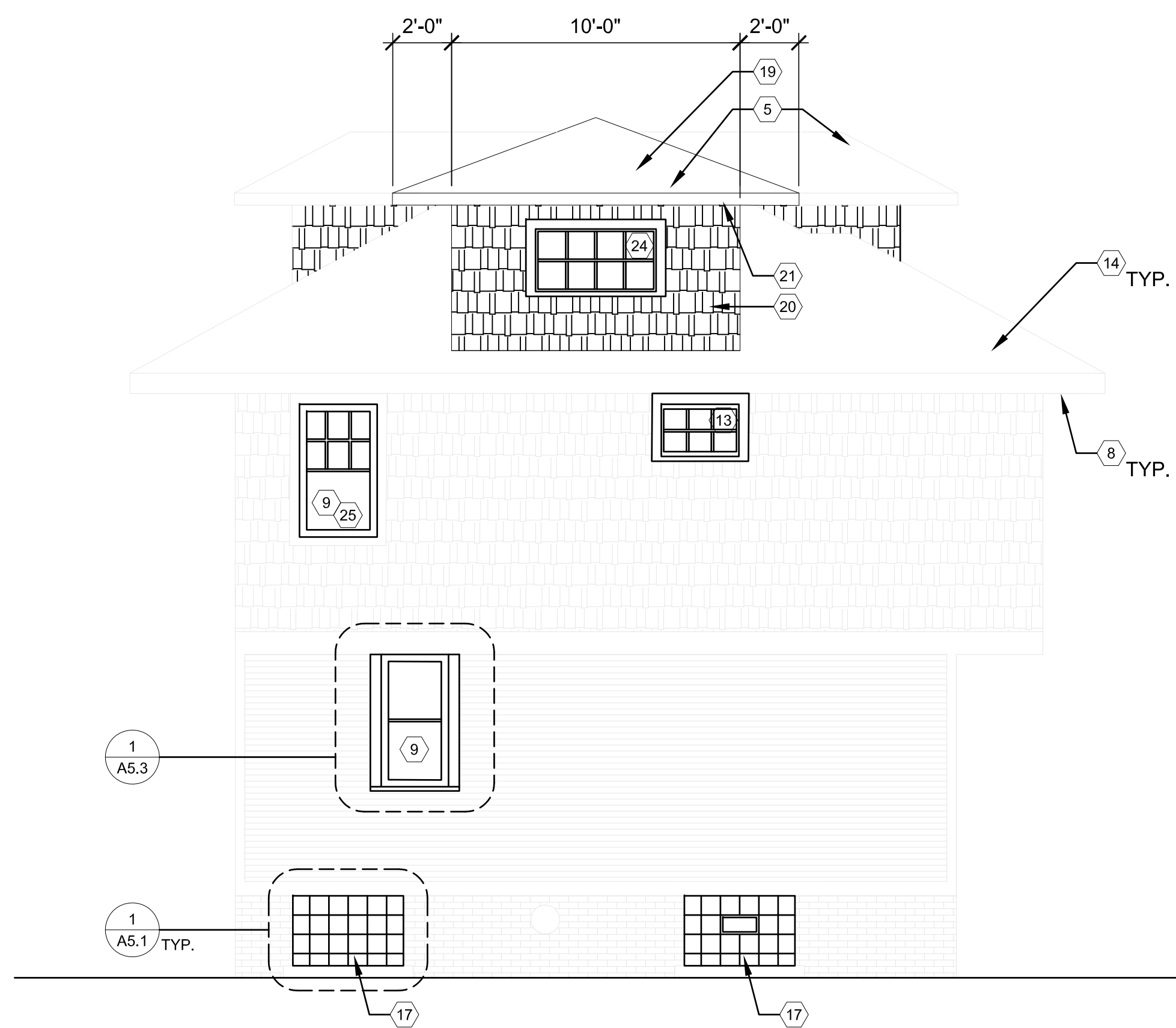

**3 EAST ELEVATION**  
SCALE: 1/4" = 1'-0"

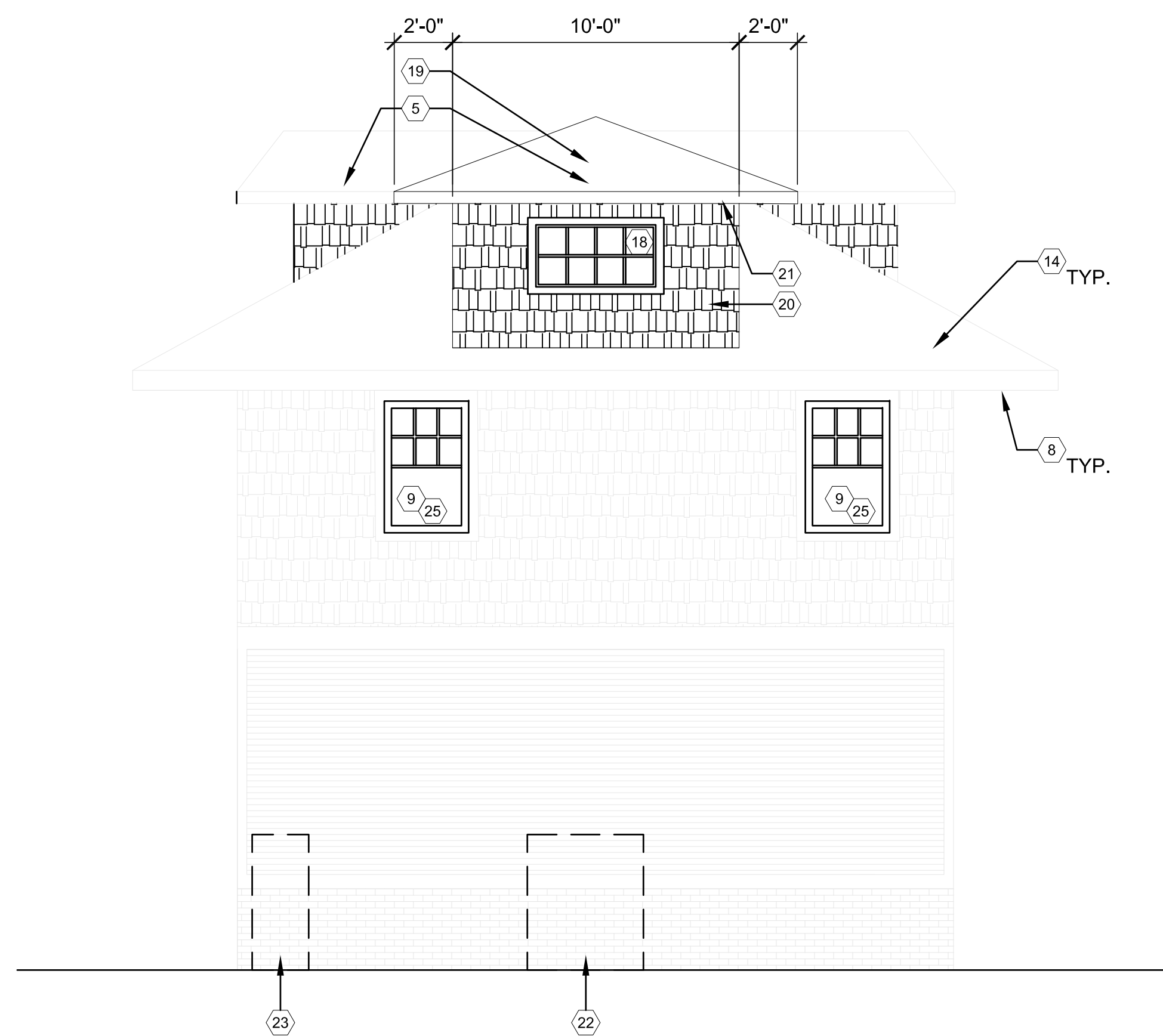

**4 WEST ELEVATION**  
SCALE: 1/4" = 1'-0"

**ELEVATION KEY NOTES:**

(TYPICAL THIS SHEET ONLY)

- ① EXISTING MASONRY PORCH; ADDED BRICK VENEER, PAINTED TO MATCH EXISTING;
- ② WOOD RAILING, MIN. 36" TALL  
SEE A5.2 FOR BASIS OF DESIGN
- ③ PINE WRAPPED 4x4 WOOD POSTS, PAINTED WHITE
- ④ NEW MASONRY STAIR
- ⑤ NEW DORMER; ROOF SHINGLES TO MATCH EXISTING
- ⑥ NEW BACK DECK AND STAIR; BASIS OF DESIGN: TREX TRANSCEND  
COMPOSITE DECKING, COLOR 'SADDLE'
- ⑦ REPLACE DAMAGED MASONRY STAIR WITH NEW
- ⑧ SOFFITS TO BE PATCHED & REPAIRED WITH IN-KIND MATERIALS
- ⑨ EXIST. SINGLE-HUNG WINDOWS REPLACED W/ VINYL-CLAD WOOD SINGLE-HUNG, PAINTED  
BLACK; (ALREADY INSTALLED); ANDERSON 400 SERIES
- ⑩ EXISTING PORCH ROOF TO REMAIN
- ⑪ EXISTING WINDOW TO BE REPAIRED, REPAINTED (BLACK)
- ⑫ REPLACE INSTALLED WINDOW WITH: ANDERSON 400 SINGLE HUNG WINDOW IN BLACK,  
WITH SIMULATED DIVIDED LITES AS SHOWN
- ⑬ REPLACE INSTALLED WINDOW WITH: ANDERSON 400 AWING WINDOW IN BLACK,  
WITH SIMULATED DIVIDED LITES AS SHOWN
- ⑭ ROOF TO BE REPAIRED AS REQ'D USING IN-KIND MATERIALS; ROOF TO BE SHINGLED WITH  
CERTAINTED LANDMARK PRO ASPHALT ROOF SHINGLES IN CINDER BLACK
- ⑮ REPLACE INSTALLED DOUBLE DOOR WITH: FRENCH DOOR, BASIS OF DESIGN: ANDERSON  
E-SERIES HINGED PATIO DOOR IN BLACK WITH 'SHORT FRACTIONAL' GRILLE STYLE.
- ⑯ COMPOSITE RAILING, MIN. 36" TALL;  
SEE A5.2 FOR BASIS OF DESIGN
- ⑰ REPLACE EXIST. BASEMENT WINDOWS WITH GLASS BLOCK (ALREADY INSTALLED);  
RESET GLASS BLOCK TO ENSURE INSTALLATION IS INSET INTO ORIGINAL WINDOW PLANE
- ⑱ REPLACE INSTALLED WINDOW WITH: ANDERSON 100 CASEMENT WINDOW IN BLACK, WITH  
SIMULATED DIVIDED LITES AS SHOWN
- ⑲ GABLE DORMER ROOF TO BE REPLACED WITH HIP ROOF TO MATCH EXISTING
- ⑳ INSTALLED COMPOSITE SIDING TO BE REPLACED WITH WOOD SHAKE SIDING, TO MATCH  
EXISTING, AND PAINTED TO MATCH EXISTING
- ㉑ ARTIFICIAL ROOF EAVE COVER(S) TO BE REMOVED; REPLACED WITH WOOD EAVE
- ㉒ LOCATION OF HVAC UNIT
- ㉓ LOCATION OF ELECTRIC METER - PLACED BY DTE ENERGY COMPANY
- ㉔ INSTALL "FAKE" WINDOW (DRYWALL INTERIOR OF WINDOW, PAINT INSIDE FACE OF  
DRYWALL WHITE); WINDOW TO BE ANDERSON 100 CASEMENT WINDOW IN BLACK, WITH  
SIMULATED DIVIDED LITES AS SHOWN
- ㉕ SIMULATED DIVIDED LITES TO BE PLACED IN PREVIOUSLY INSTALLED WINDOWS AS SHOWN

GENERAL NOTE: ROOF, EXTERIOR CLADDING TO BE PATCHED AND REPAIRED AS REQ'D.  
ALL REPAIRS TO USE IN-KIND MATERIALS.

HOUSE TO BE PAINTED IN ACCORDANCE WITH HDC COLOR SYSTEM E  
ALL SIDING TO BE C4 YELLOWISH WHITE  
ALL TRIM AND SASH TO BE B:19 BLACK  
SEE A6.1 FOR COLOR RENDER

ARCHITECT:

**4545** architecture

2761 E. JEFFERSON AVE  
STE 302  
DETROIT, MI 48207  
P. 313.454.4545  
TIM.FLINTOFF@4545ARCHITECTURE.COM

CONSULTANT:

Project :  
**708 PALLISTER  
HDC RENOVATION**

Issued for :  
**HDC SUBMIT 02/18/2025**

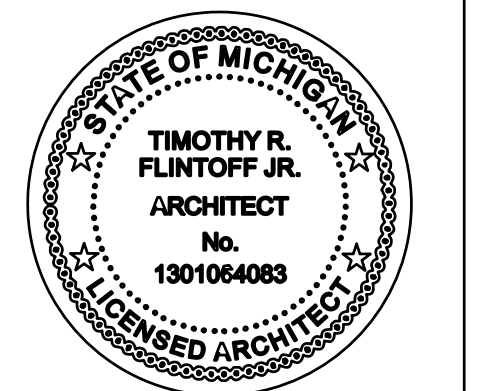

Drawn by :  
ANJ  
Check by :  
TRF

Sheet Title :  
EXTERIOR  
ELEVATIONS

Project No. :  
**2024001**

Sheet No. :  
**A3.1**

**GENERAL FLOOR PLAN NOTES:**

1. THIS DRAWING IS DIAGRAMMATIC AND SHOULD BE USED TO DETERMINE THE DESIGN INTENT. THE CONTRACTOR IS RESPONSIBLE FOR THE COMPLETE SET OF WORK AS INDICATED AND SHALL FIELD VERIFY ALL WORK, COORDINATE ALL DRAWINGS / NEW WORK AND SHALL NOTIFY ARCHITECT IMMEDIATELY OF ANY DISCREPANCIES IN THE DOCUMENTS BEFORE PROCEEDING. FAILURE TO DO SO WILL RESULT IN THE CONTRACTOR TAKING FULL RESPONSIBILITY AND LIABILITY FOR SAID DISCREPANCIES.
2. ALL DIMENSIONS ARE SHOWN FROM FINISH FACE TO FINISH FACE OF PARTITION UNLESS OTHERWISE NOTED.
3. WALL THICKNESS' ARE NOMINAL NOT ACTUAL DIMENSIONS. SEE WALL SCHEDULE FOR ACTUAL DIMENSIONS.
4. ALL WORK SHALL BE DONE IN ACCORDANCE WITH ALL LOCAL, STATE, COUNTY CODE REGULATIONS, O.S.H.A., AND THE AMERICAN WITH DISABILITIES ACT (ADA). REFER TO THE CODE PLAN FOR MORE INFORMATION.
5. PROVIDE POSITIVE SLOPE TO ALL FLOOR DRAINS WHILE KEEPING FLOOR LEVEL AT WALL BASE CONDITION.

**PLAN KEY NOTES:**

(TYPICAL THIS SHEET ONLY)

- ① LINE OF WALLS BELOW
  - ② NEW DORMER ROOF TO REMAIN
  - ③ EXISTING ROOF TO BE REPAIRED WITH IN-KIND MATS. AS REQ'D (TYP.) SHINGLES TO BE REPLACED WITH CERTAINTED LANDMARK PRO ROOF SHINGLES IN CINDER BLACK
  - ④ FINAL LAYOUT OF INTERIOR KNEE WALLS TO BE DETERMINED BY EXISTING CONDITIONS AND OWNER INTERIOR CONFIGURATIONS, COORDINATE WITH OWNER (WORK COMPLETED)
  - ⑤ NEW WINDOW, SEE ELEVATIONS
  - ⑥ DORMER ROOF TO BE REMOVED, REPLACED WITH COORDINATING GABLE ROOF, SEE ELEVATIONS
- GENERAL NOTE: SEE A4.1 FOR ROOF FRAMING PLAN

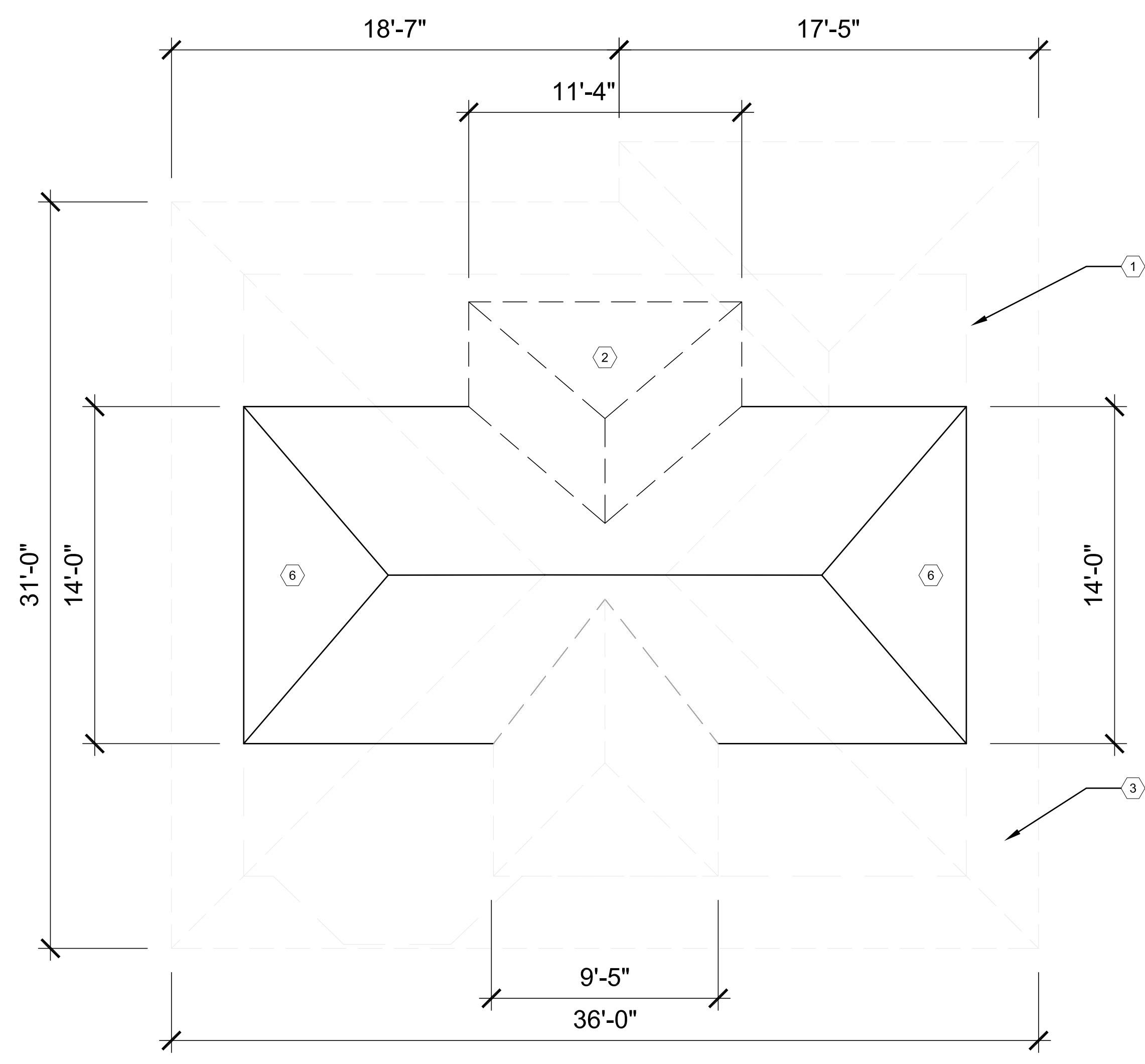
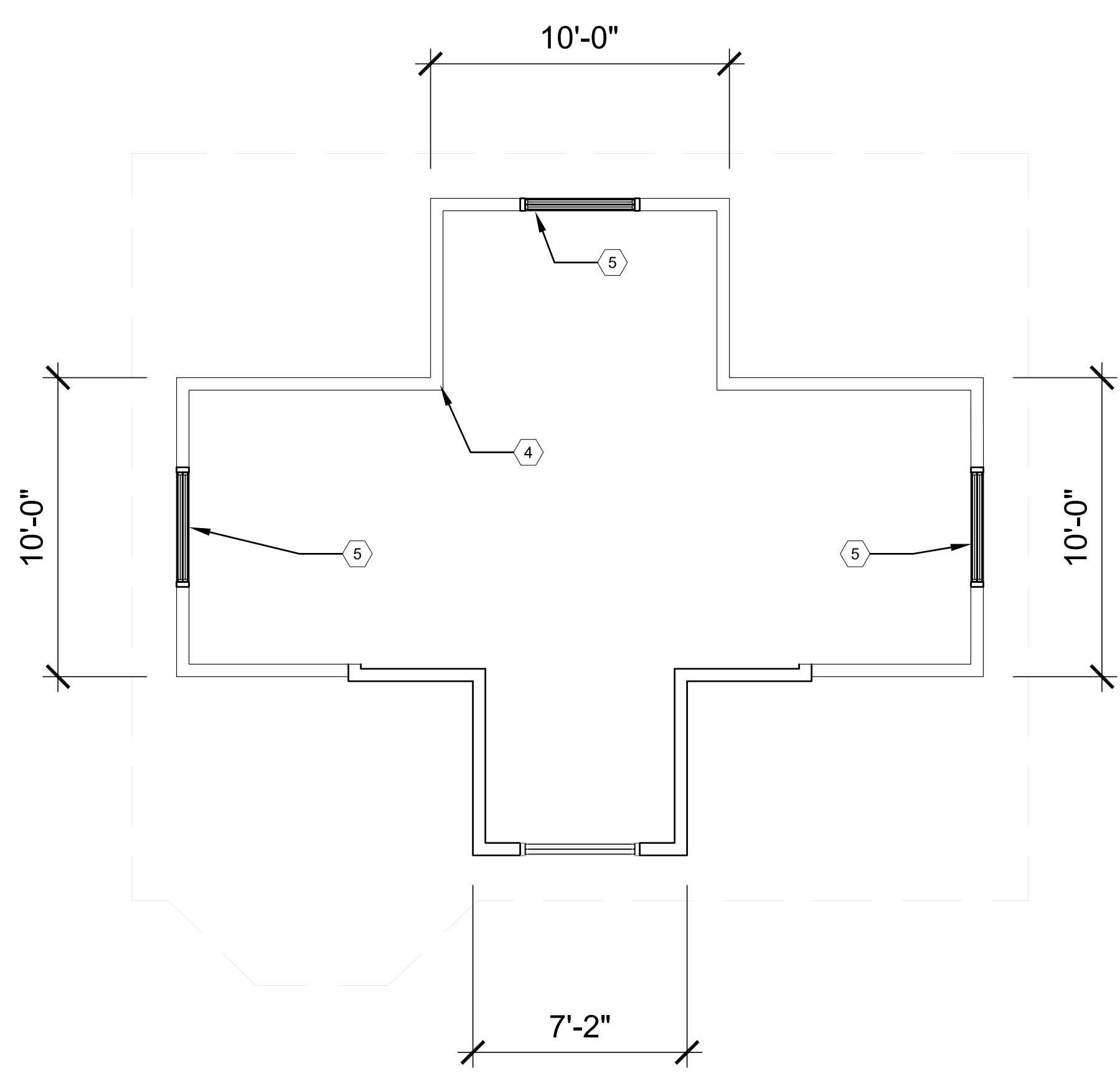

**ROOF PLAN**  
SCALE: 1/4"=1'-0"

**ROOF PLAN**  
SCALE: 1/4"=1'-0"

DO NOT SCALE DRAWINGS | ©2024 Timothy Flintoff Architect, PLLC

<p>ARCHITECT:</p> <p><b>4545</b> architecture</p> <p>2761 E. JEFFERSON AVE STE 302 DETROIT, MI 48207 P. 313.454.4545 TIM.FLINTOFF@4545ARCHITECTURE.COM</p>
<p>CONSULTANT:</p>
<p>Project :</p> <p><b>708 PALLISTER HDC RENOVATION</b></p>
<p>Issued for :</p> <p><b>HDC SUBMIT 02/18/2025</b></p>
<p>Drawn by : <b>ANJ</b></p> <p>Check by : <b>TRF</b></p>
<p>Sheet Title :</p> <p><b>3RD FLOOR AND ROOF PLAN</b></p>
<p>Project No. :</p> <p><b>2024001</b></p>
<p>Sheet No. :</p> <p><b>A1.2</b></p>

# FRONT PORCH RAILING

AMERICAN PORCH  
4" 3 PC. PORCH RAIL SYSTEM,  
CEDAR  
WITH BOTTOM RAIL

AMERICAN PORCH  
1-5/8" SQUARE BALUSTER,  
CEDAR  
32" LENGTH

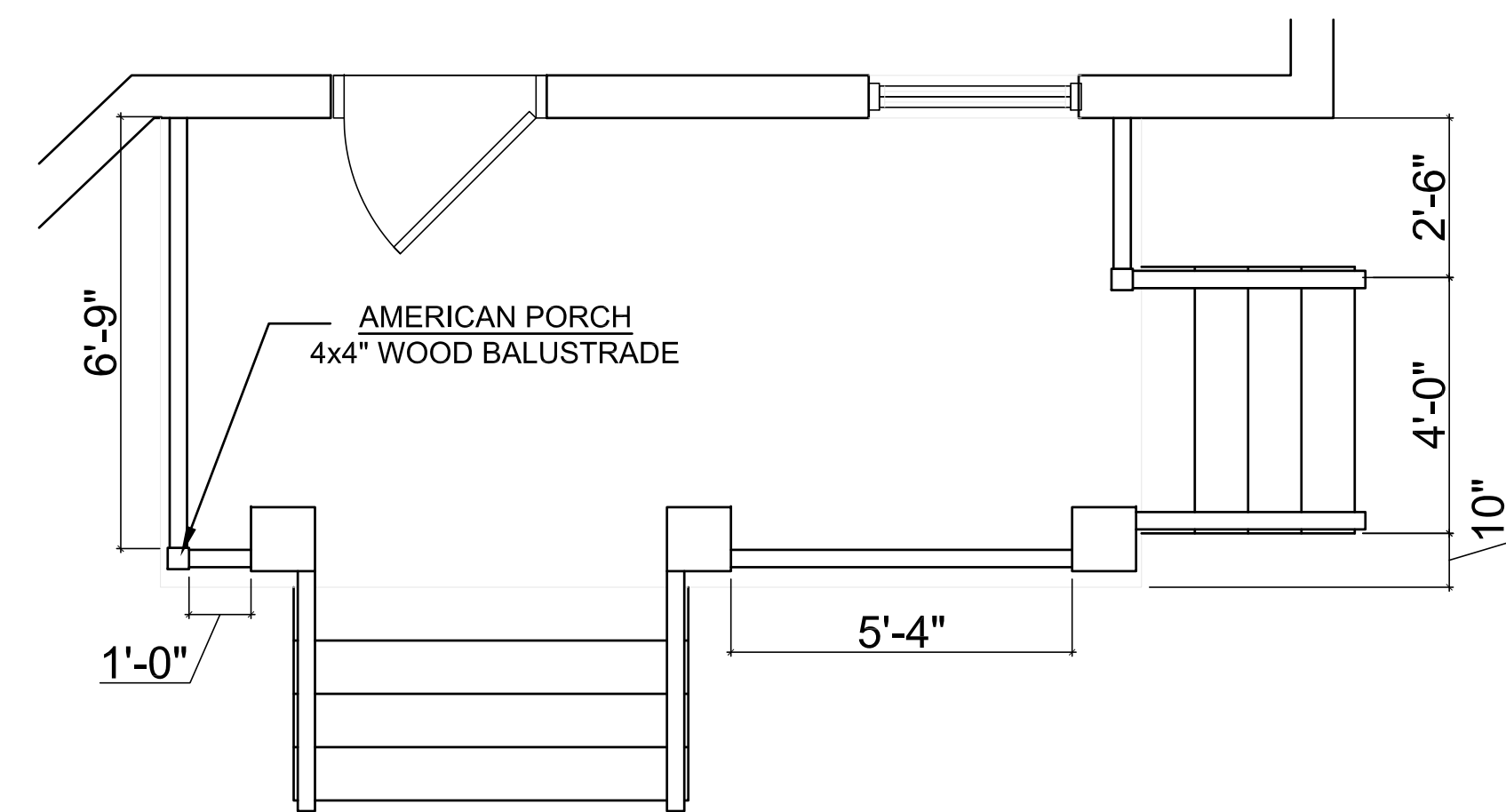
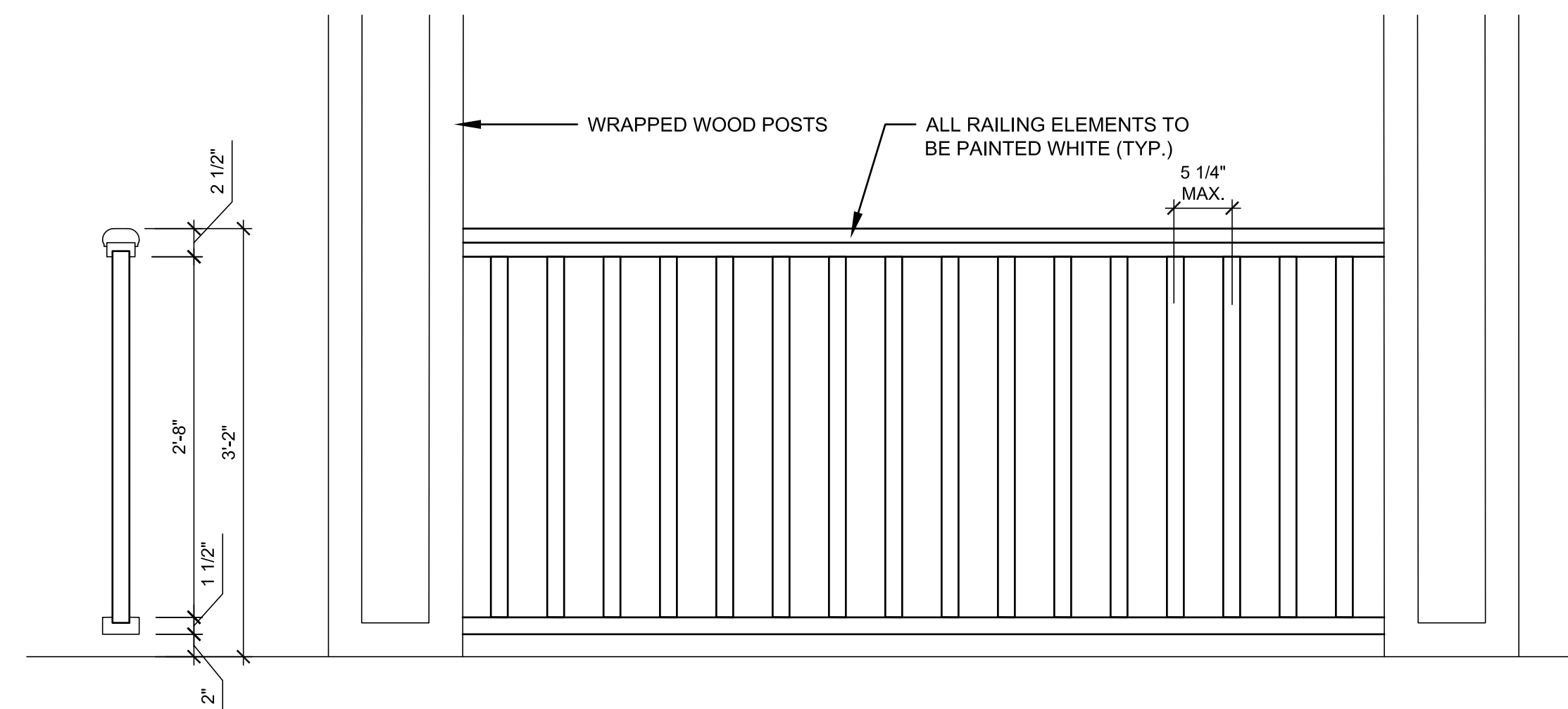
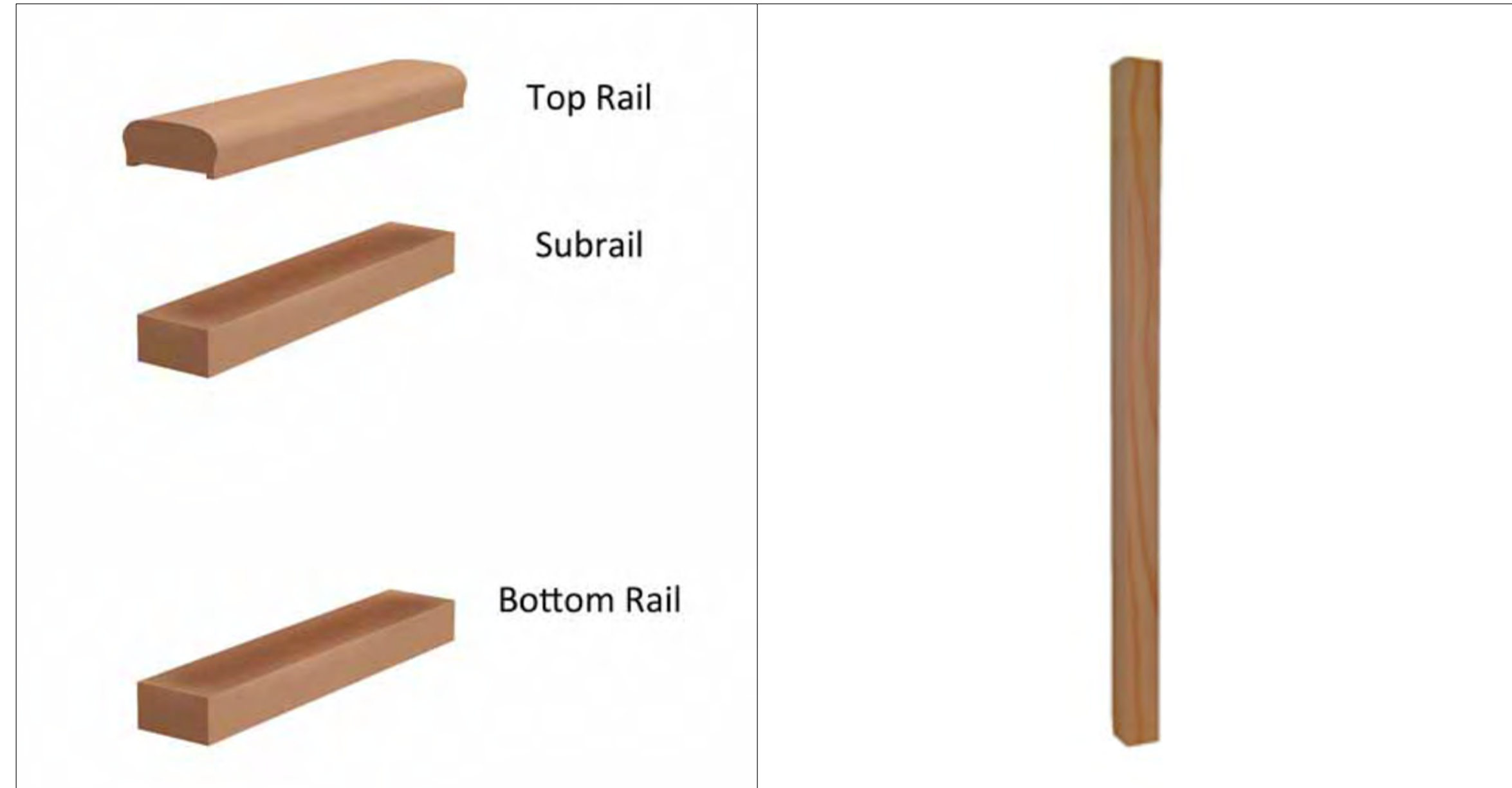

# REAR DECK RAILING

Trex Transcend® | Trex

**RAIL KITS**

COMPONENT	RAIL & SQUARE COMPOSITE BALUSTER KIT	RAIL & ROUND ALUMINUM BALUSTER KIT	COCKTAIL RAIL & ROUND ALUMINUM BALUSTER KIT*
Top Rail	Crown	Crown	Universal
Bottom Rail	Universal	Universal	Universal
Heights	36" (914 mm) 42" (1066 cm)	36" (914 mm) 42" (1066 cm)	36" (914 mm)
Lengths	67.5' (171 cm) 91.5' (232 cm)	67.5' (171 cm) 91.5' (232 cm)	67.5' (171 cm) 91.5' (232 cm)
Applications	Horizontal, Stair	Horizontal, Stair	Horizontal, Stair
Colors	WT, BK, VL	WT, BK, VL (round aluminum balusters come in BK)	WT (round aluminum balusters come in BK)

\*A cocktail rail allows for a Trex Transcend® or Trex Select® deck board to be installed on top of a Universal top/bottom rail. All deck boards sold separately.

**COLORS**

Composite	Aluminum
Classic White	Classic White
Charcoal Black	Bronze
Grain Path	Charcoal Black
Rope Swing	
Trex Mouse	
Vintage Lantern	

**CODE REQUIREMENTS**

Trex Transcend Railing meets both IRC and IBC designated requirements in accordance with ICC-ES AC174 and ASTM D7032. Refer to Code Compliance Report CCRR-0132 for specific details.

**HARDWARE**

**Mounting Hardware for Cut Rails**

The perfect solution for any installation that requires making two railing sections from one kit. Includes 2 Crown top rail gaskets, 4 Universal top/bottom rail gaskets, 4 RSB rail brackets, 8 rail-to-bracket fasteners and 8 rail-to-post fasteners.

**QUESTIONS?**  
Connect with our pro services team at  
1-800-BUY-TREX or [customer@trex.com](mailto:customer@trex.com)

0321 © 2021 Trex Company, Inc. All rights reserved. Trex®, the Trex logo, Trex Transcend® and Trex Select® are either federally registered trademarks, trademarks or trade dress of Trex Company, Inc., Winchester, Virginia or its licensees. TRLTYCHDOC2021

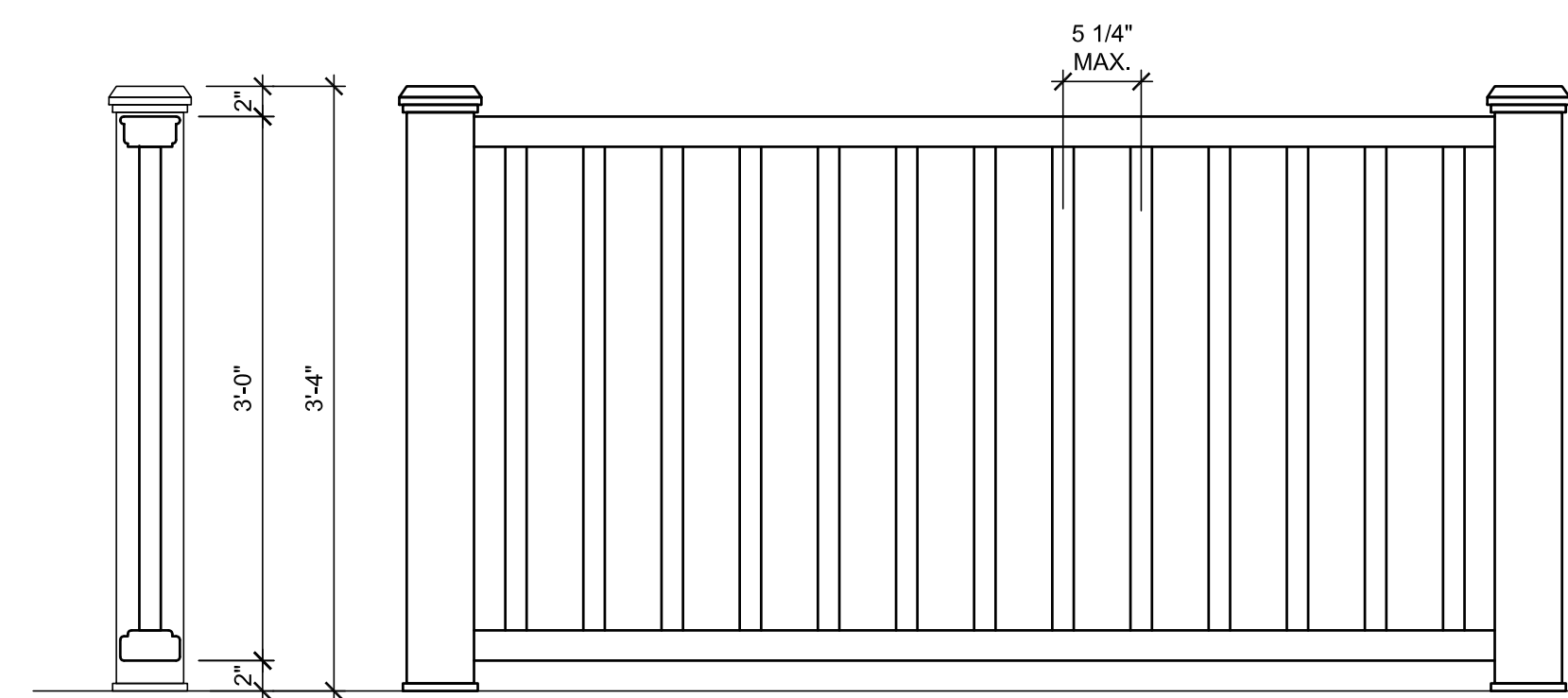

ARCHITECT:  
**4545** architecture  
2761 E. JEFFERSON AVE  
STE 302  
DETROIT, MI 48207  
P. 313.454.4545  
TIM.FLINTOFF@4545ARCHITECTURE.COM

CONSULTANT:

Project :  
**708 PALLISTER  
HDC RENOVATION**

Issued for :  
**HDC SUBMIT 02/18/2025**

Drawn by :  
ANJ  
Check by :  
TRF

Sheet Title :  
**RAILING  
DETAILS**

Project No. :  
**2024001**

Sheet No. :  
**A5.2**

DO NOT SCALE DRAWINGS | ©2024 Timothy Flintoff Architect, PLLC

'BELT BAND' 1x BOARD TO BE PARTIALLY REMOVED, REPLACED TO MAINTAIN CONSISTENT LINEAR FORM

REMOVE EMBEDDED TRIM (TYP.)

NEW WINDOW TRIM TO TERMINATE AT BOTTOM OF 'BELT BAND' BETWEEN FIRST AND SECOND STORIES

.75"x4.5" WOOD TRIM, TO BE SET ON TOP OF SIDING TO MATCH EXISTING

MATCH CORNER JOINTS TO EXISTING

1-3/4" (DEPTH) WOOD TRIM, SET FLAT TO MIMIC SILL, TO MATCH EXISTING

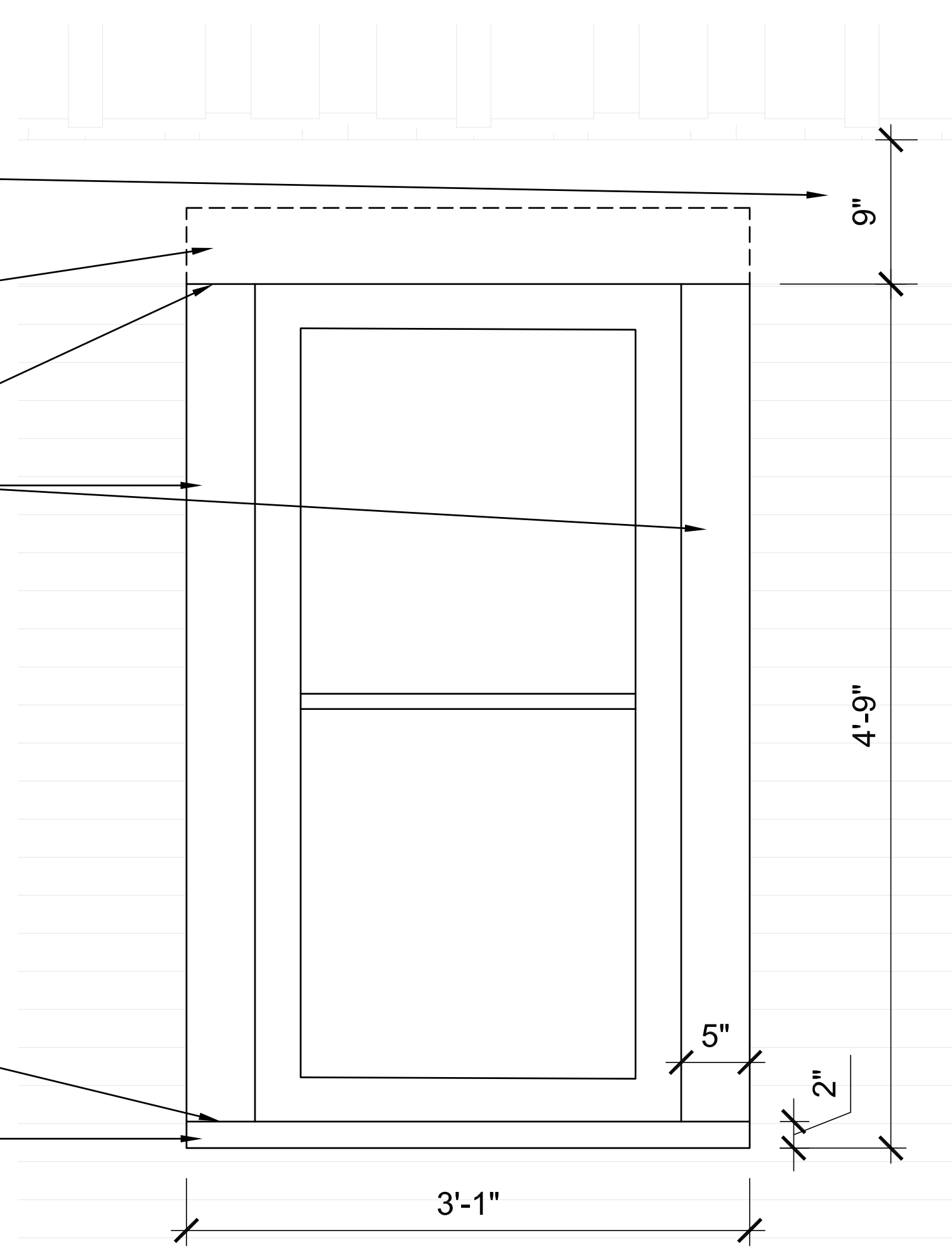

**1** NEW WINDOW FRAMING DETAIL  
SCALE: 1-1/2" = 1'-0"

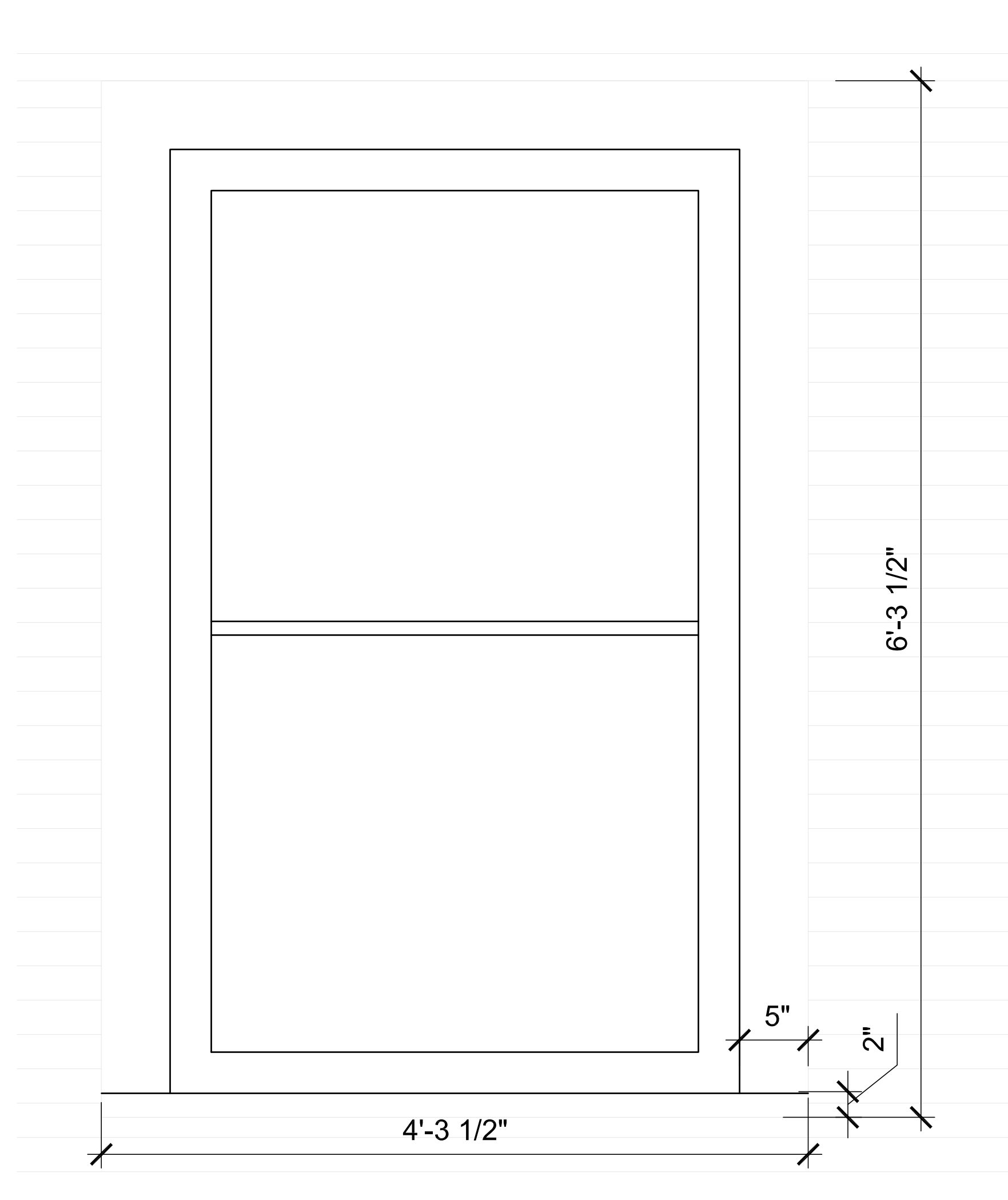

**4** FRONT ELEVATION EXISTING WINDOW FRAMING DETAIL  
SCALE: 1-1/2" = 1'-0"



**2** PREVIOUS WINDOW FRAMING DETAIL  
(INFILLED WINDOW AT EAST ELEVATION)

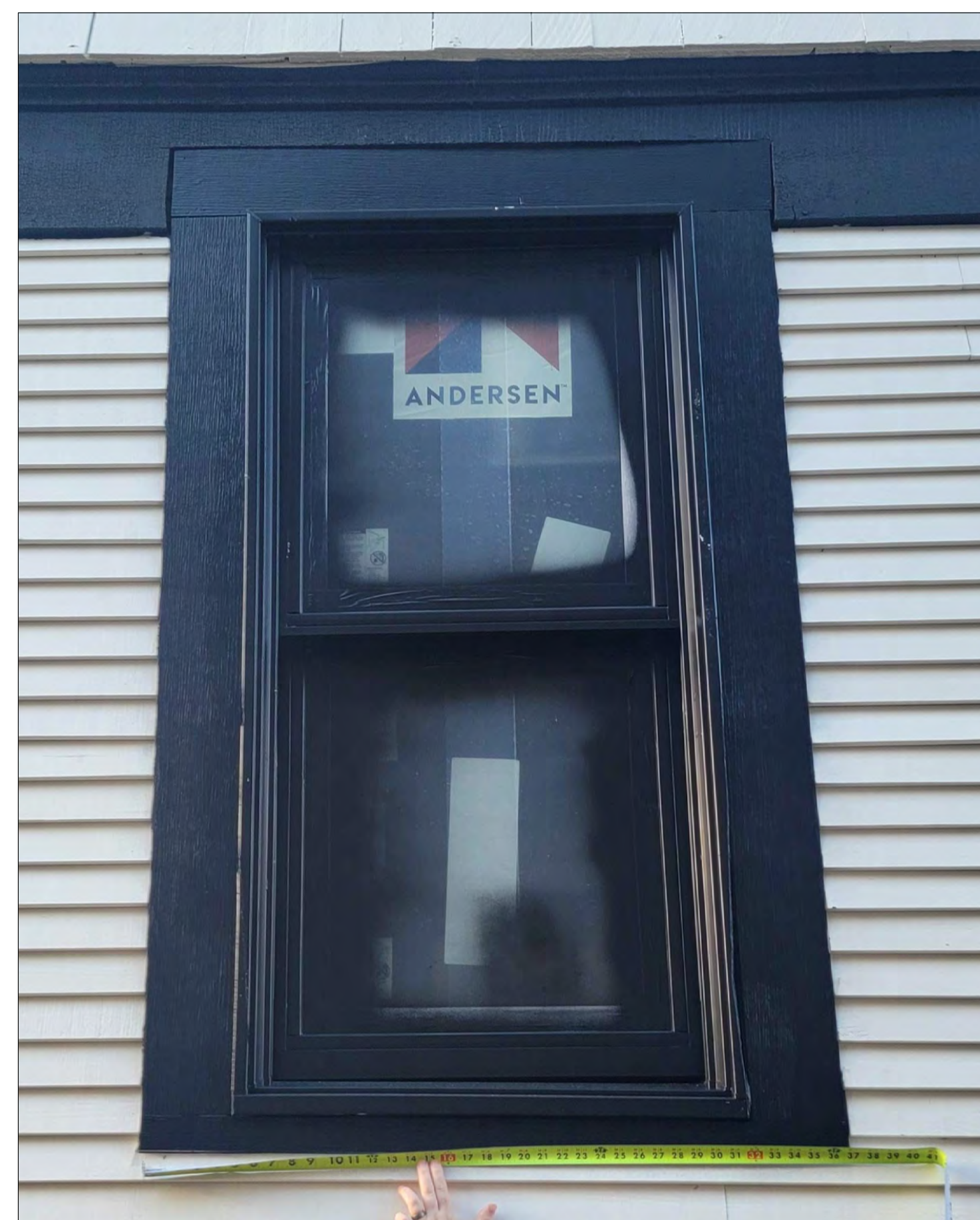

**3** NEW WINDOW PHOTO  
TAKEN NOVEMBER 26, 2024



**5** FRONT ELEVATION EXISTING WINDOW PHOTO  
TAKEN NOVEMBER 26, 2024

ARCHITECT: <b>4545</b> architecture 2761 E. JEFFERSON AVE STE 302 DETROIT, MI 48207 P. 313.454.4545 TIM.FLINTOFF@4545ARCHITECTURE.COM	
CONSULTANT:	
Project : <b>708 PALLISTER                  HDC RENOVATION</b>	
Issued for : <b>HDC SUBMIT 02/18/2025</b>	
Drawn by : ANJ Check by : TRF	
Sheet Title : <b>WINDOW TRIM                  DETAILS</b>	
Project No. : <b>2024001</b>	
Sheet No. : <b>A5.3</b>	

DO NOT SCALE DRAWINGS | ©2024 Timothy Flintoff Architect, PLLC

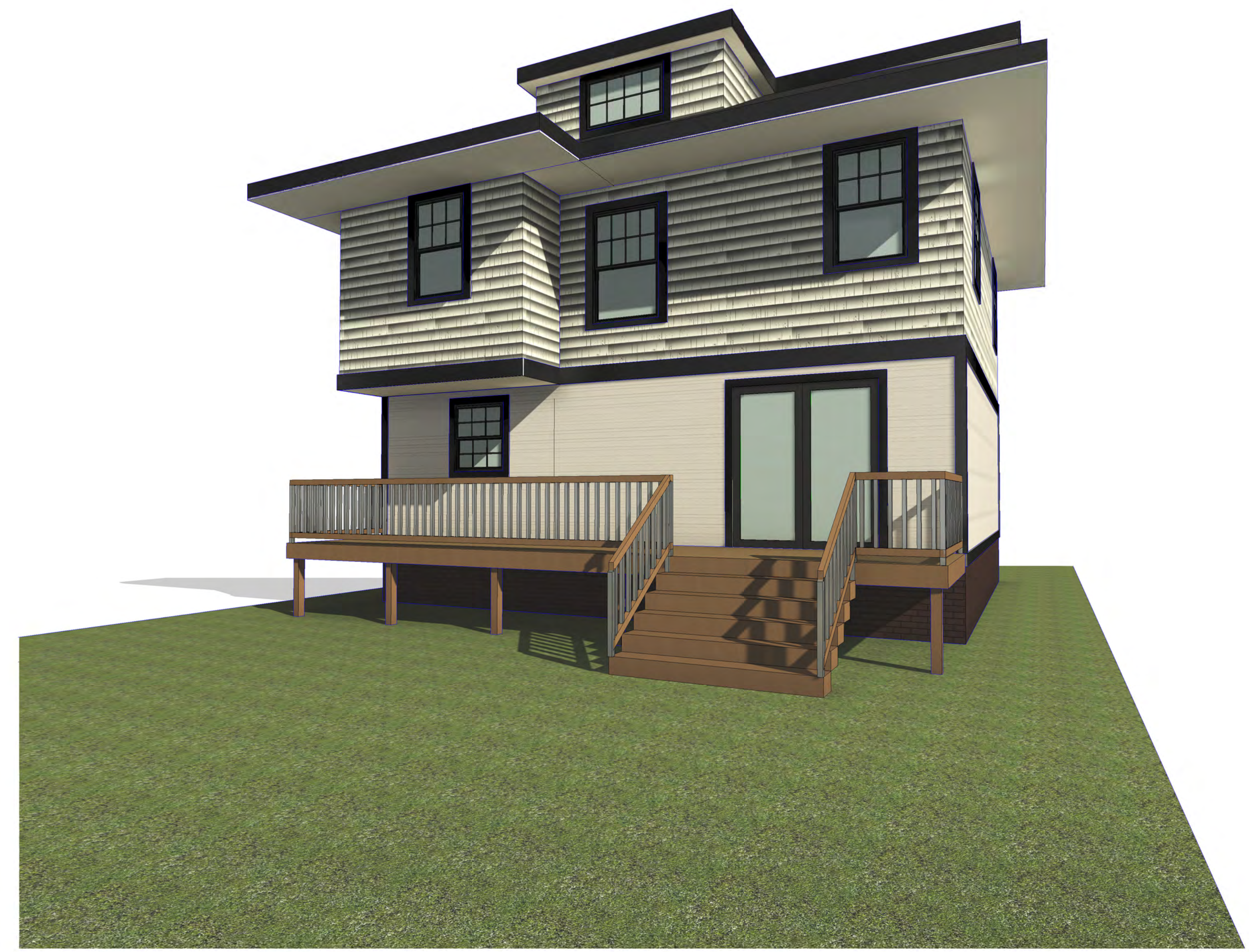
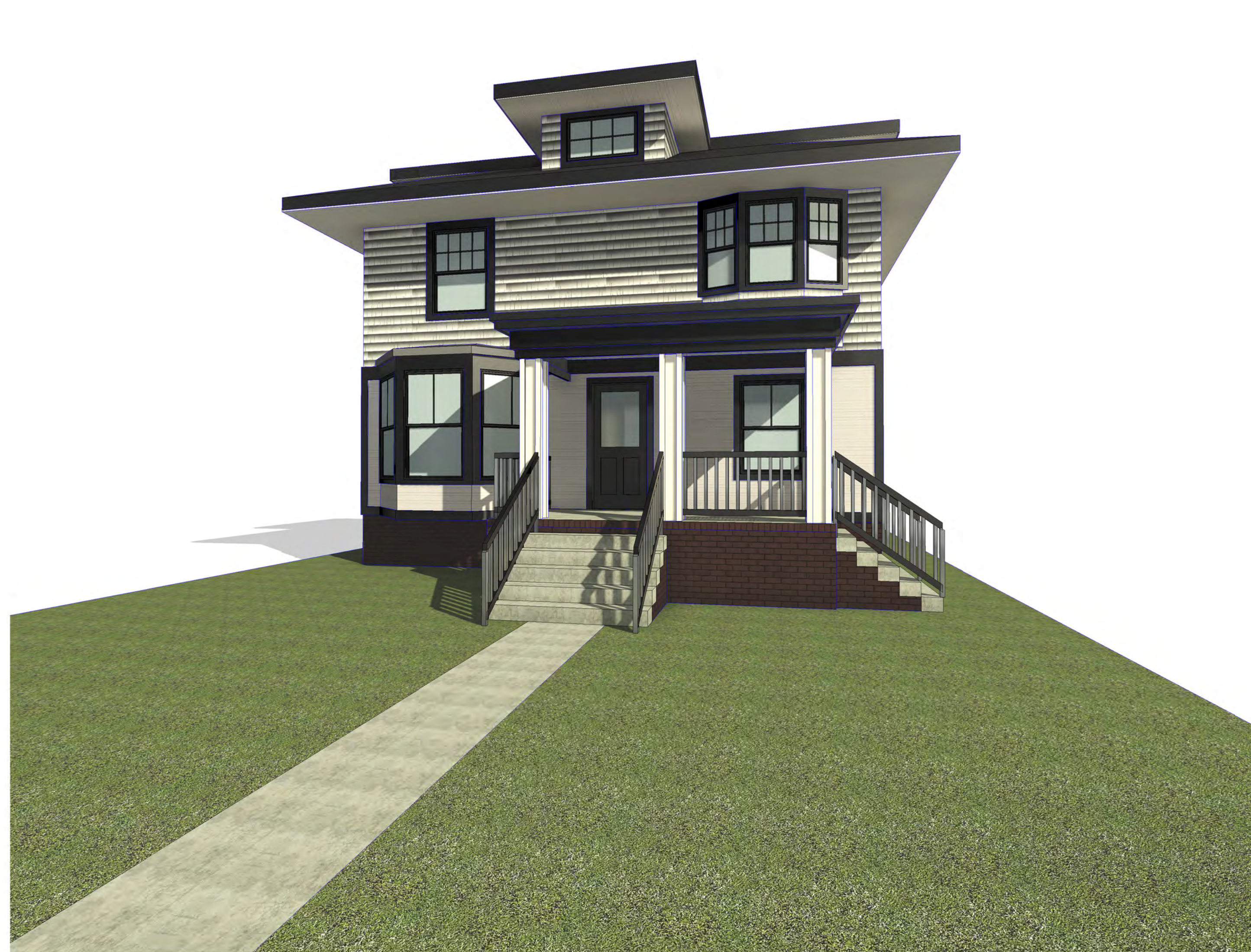

ARCHITECT:  
**4545** architecture  
 2761 E. JEFFERSON  
 SUITE 302  
 DETROIT, MI 48207  
 P. 313.450.4545  
 TM.FLINTOFF@4545ARCHITECTURE.COM

CONSULTANT:

Project :  
 708 PALLISTER  
 HDC RENOVATION

Issued for :  
 HDC SUBMIT 02/18/2025



Drawn by :  
 Author  
 Checked by :  
 Author

Sheet Title :  
 3D RENDERS

Project No. :  
 2024001

Sheet No. :  
**A6.1**



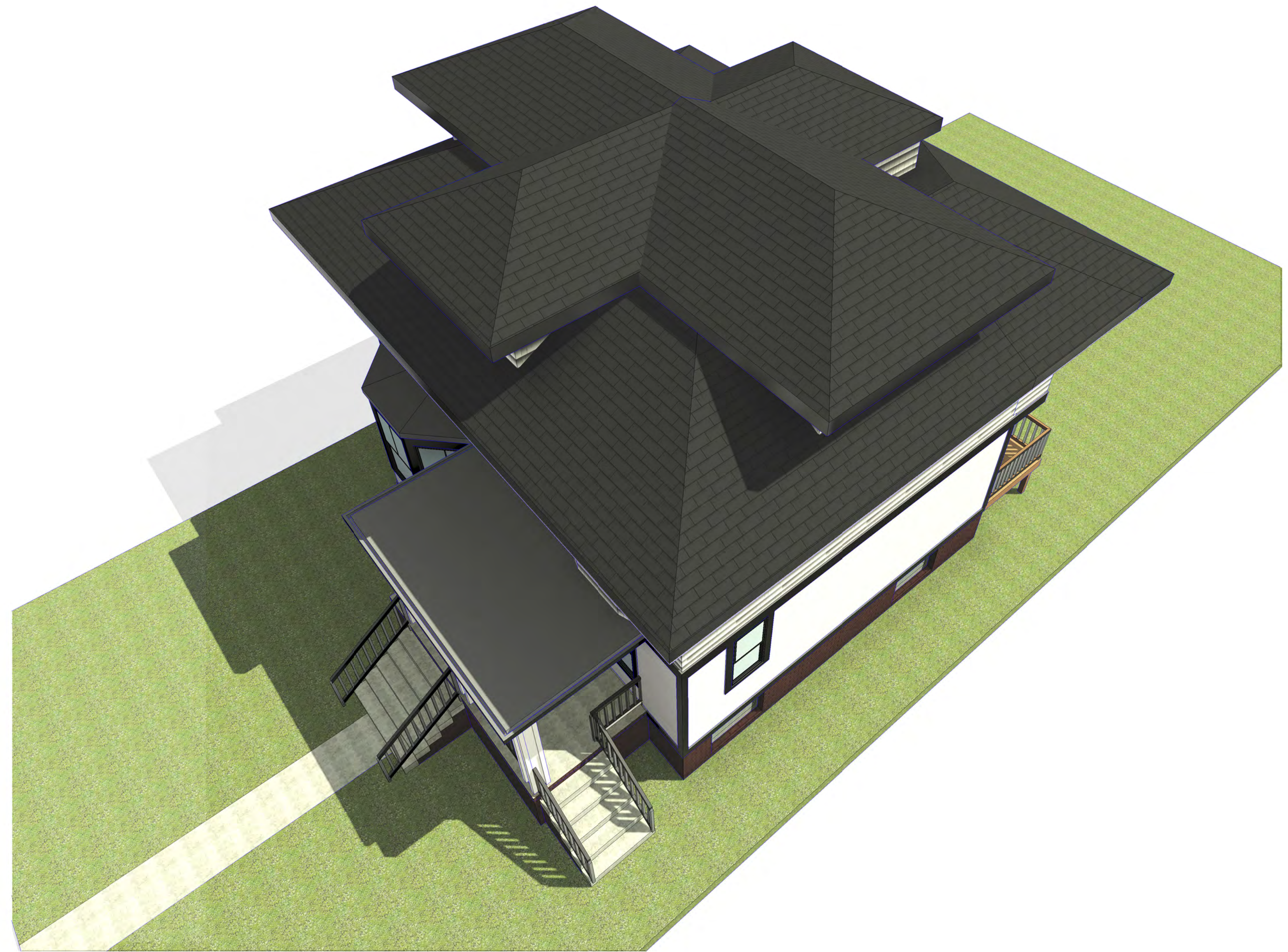
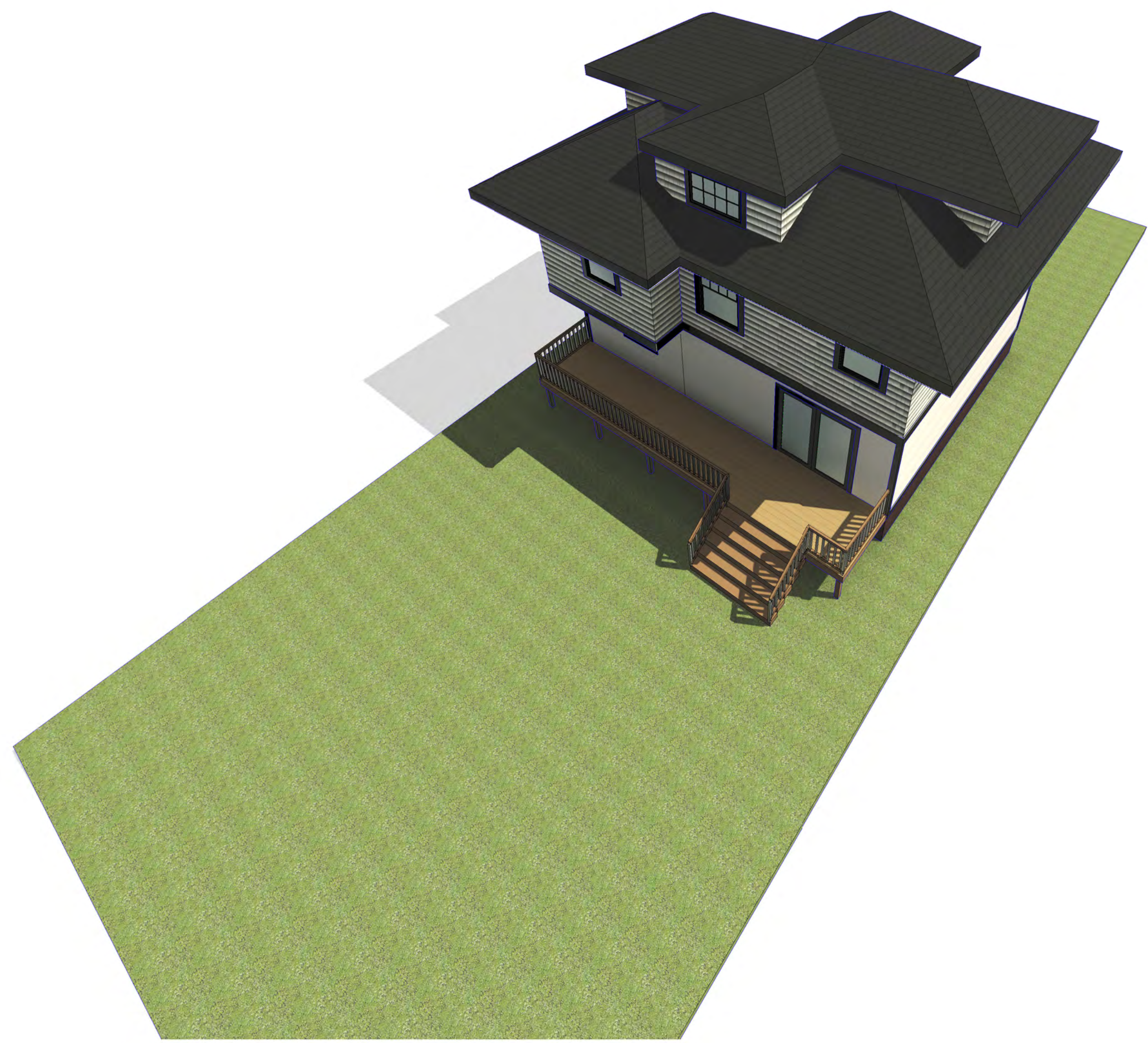

ARCHITECT:  
**4545** architecture  
2761 E. JEFFERSON  
SUITE 302  
DETROIT, MI 48207  
P. 313.450.4545  
TM.FLINTOFF@4545ARCHITECTURE.COM

CONSULTANT:

Project :  
708 PALLISTER  
HDC RENOVATION

Issued for :  
HDC SUBMIT 02/18/2025



Drawn by :  
Author  
Checked by :  
Author

Sheet Title :  
3D RENDERS

Project No. :  
2024001

Sheet No. :  
**A6.2**

# 708 PALLISTER RENOVATION

EXTERIOR RENOVATION  
708 PALLISTER STREET,  
DETROIT, MI. 48202



### SHEET INDEX

SP1.1	SITE PLAN
D1.1	DEMO PLANS
D3.1	DEMO ELEVATIONS
A1.1	FOUNDATION AND FIRST FLOOR PLANS
A1.2	THIRD FLOOR AND ROOF PLANS
A3.1	EXTERIOR ELEVATIONS
A3.2	EXTERIOR ELEVATION PHOTOS
A3.3	EXTERIOR ELEVATION PHOTOS
A3.4	EXTERIOR ELEVATION PHOTOS
A3.5	GARAGE ELEVATION PHOTOS
A3.6	GARAGE ELEVATION PHOTOS
A4.1	DORMER FRAMING DETAILS
A5.1	ARCHITECTURAL DETAILS
A5.2	RAILING DETAILS
A5.3	WINDOW TRIM DETAILS
A6.1	3D RENDERS
A6.2	3D RENDERS

**ARCHITECT**  
**4545 ARCHITECTURE | DESIGN, PLLC**  
**TIMOTHY FLINTOFF, AIA, NCARB**  
**2761 E JEFFERSON, SUITE 302**  
**DETROIT, MI 48207**  
**248-320-6098**

**PROJECT DATA**  
**BUILDING CODE AUTHORITY:**  
CITY OF DETROIT, MICHIGAN

**OWNER:**  
THOMAS TYPINKSKI  
708 PALLISTER ST.,  
DETROIT, MI 48202

**APPLICABLE CODES:**  
BUILDING CODE  
ALSO KNOWN AS THE "MICHIGAN RESIDENTIAL CODE"  
2015 MICHIGAN RESIDENTIAL CODE (MRC) AS AMENDED  
APPENDIX J. EXISTING BUILDING AND STRUCTURES

**MECHANICAL CODE**  
ALSO KNOWN AS THE "MICHIGAN MECHANICAL CODE"  
2021 MICHIGAN MECHANICAL CODE AS AMENDED

**PLUMBING CODE**  
ALSO KNOWN AS THE "MICHIGAN PLUMBING CODE"  
2021 MICHIGAN PLUMBING CODE AS AMENDED

**ELECTRICAL CODE**  
ALSO KNOWN AS THE "MICHIGAN ELECTRICAL CODE"  
2023 NATIONAL ELECTRIC CODE (NEC) AS AMENDED & MICHIGAN  
AMMENDMENTS PART 8.

**ENERGY CODE**  
2015 UNIFORM ENERGY CODE

**BARRIER FREE REQUIREMENTS**  
AMERICANS WITH DISABILITIES ACT (ADA)  
MBC-2015, CHAPTER 11  
ICC / ANSI 117.1 - 2010, EXCEPT SECTION 611 & 707

**BUILDING DATA:**

LOT SIZE: 5,800 GSF  
EXIST. BUILDING FOOTPRINT: 770 GSF  
STORIES: 3                      SPRINKLERED: NO

**BUILDING CODE INFORMATION:**  
OCCUPANCY/USE

R-2 RESIDENTIAL - SINGLE FAMILY

**CONSTRUCTION TYPE:**

V-B (EXISTING AND PROPOSED)

**REQUIRED EXITS:**

DWELLING UNIT: 1 EXIT + 1 EMERGENCY WINDOW  
EGRESS PER UNIT

**PROVIDED EXITS:**

DWELLING UNIT: 2 EXTERIOR EXITS + 1 EMERGENCY  
WINDOW EXIT



PROJECT LOCATION  
708 PALLISTER ST.

**PROJECT SITE MAP: NOT TO SCALE**

SYMBOL LEGEND		ABBREVIATION	
	DARKENED ARROW INDICATES ELEVATED SECTION	ACUST.	ACOUSTICAL
	ELEVATION NUMBER	A.C.T.	ACOUSTIC CEILING TILE
	SHEET NUMBER WHERE ELEVATION IS LOCATED	ADJ.	ADJACENT
	ELEVATION NUMBER	A.F.F.	ABOVE FINISH FLOOR
	SHEET NUMBER WHERE ELEVATION IS LOCATED	ALUM.	ALUMINUM
	ELEVATION NUMBER	ANOD.	ANODIZED
	SHEET NUMBER WHERE ELEVATION IS LOCATED	BD.	BOARD
	ELEVATION NUMBER	BLDG.	BUILDING
	SHEET NUMBER WHERE ELEVATION IS LOCATED	BLK.	BLOCK
	ELEVATION NUMBER	BLKG.	BLOCKING
	SHEET NUMBER WHERE ELEVATION IS LOCATED	CEM.	CEMENT
	ELEVATION NUMBER	C.J.	CONTROL JOINT
	SHEET NUMBER WHERE ELEVATION IS LOCATED	CLG.	CEILING
	ELEVATION NUMBER	CL.	CENTER LINE
	SHEET NUMBER WHERE ELEVATION IS LOCATED	C.O.	CLEAN OUT
	ELEVATION NUMBER	COL.	COLUMN
	SHEET NUMBER WHERE ELEVATION IS LOCATED	CONC.	CONCRETE
	ELEVATION NUMBER	C.G.	CORNER GUARD
	SHEET NUMBER WHERE ELEVATION IS LOCATED	CONSTR.	CONSTRUCTION
	ELEVATION NUMBER	CONT.	CONTINUOUS
	SHEET NUMBER WHERE ELEVATION IS LOCATED	CORR.	CORRUGATED
	ELEVATION NUMBER	CPT.	CARPET
	SHEET NUMBER WHERE ELEVATION IS LOCATED	C.T.	CERAMIC TILE
	ELEVATION NUMBER	DET.	DETAIL
	SHEET NUMBER WHERE ELEVATION IS LOCATED	DIA.	DIAMETER
	ELEVATION NUMBER	DN.	DOWN
	SHEET NUMBER WHERE ELEVATION IS LOCATED	DN.	DOWN
	ELEVATION NUMBER	D.O.	DOOR OPENING
	SHEET NUMBER WHERE ELEVATION IS LOCATED	DR.	DOOR
	ELEVATION NUMBER	DWG.	DRAWING
	SHEET NUMBER WHERE ELEVATION IS LOCATED	EA.	EACH
	ELEVATION NUMBER	ELEV.	ELEVATION
	SHEET NUMBER WHERE ELEVATION IS LOCATED	E.W.	EACH WAY
	ELEVATION NUMBER	EXG.	EXISTING
	SHEET NUMBER WHERE ELEVATION IS LOCATED	EXIST.	EXISTING
	ELEVATION NUMBER	EXP.	EXPANSION, EXPOSED
	SHEET NUMBER WHERE ELEVATION IS LOCATED	EXT.	EXTERIOR
	ELEVATION NUMBER	F.D.	FLOOR DRAIN
	SHEET NUMBER WHERE ELEVATION IS LOCATED	FDN.	FOUNDATION
	ELEVATION NUMBER	F.R.P.	FIBER REINFORCED PANELS
	SHEET NUMBER WHERE ELEVATION IS LOCATED	FIN.	FINISH
	ELEVATION NUMBER	FLR.	FLOOR
	SHEET NUMBER WHERE ELEVATION IS LOCATED	F.O.	FACE OF
	ELEVATION NUMBER	F.O.S.	FACE OF STUD
	SHEET NUMBER WHERE ELEVATION IS LOCATED	FR.	FRAME
	ELEVATION NUMBER	FTG.	FOOTING
	SHEET NUMBER WHERE ELEVATION IS LOCATED	FV.	FIELD VERIFY
	ELEVATION NUMBER	GA.	GAUGE
	SHEET NUMBER WHERE ELEVATION IS LOCATED	GALV.	GALVANIZED
	ELEVATION NUMBER	GYP.	GYPSUM
	SHEET NUMBER WHERE ELEVATION IS LOCATED	HDW.	HARDWARE
	ELEVATION NUMBER	H.M.	HOLLOW METAL
	SHEET NUMBER WHERE ELEVATION IS LOCATED	HT.	HORIZONTAL
	ELEVATION NUMBER	HT.	HEIGHT
	SHEET NUMBER WHERE ELEVATION IS LOCATED	I.D.	INSIDE DIAMETER
	ELEVATION NUMBER	INSUL.	INSULATION
	SHEET NUMBER WHERE ELEVATION IS LOCATED	INT.	INTERIOR
	ELEVATION NUMBER	JOINT.	JOINT
	SHEET NUMBER WHERE ELEVATION IS LOCATED	JT.	JAVATORY
	ELEVATION NUMBER	L.G.	LONG
	SHEET NUMBER WHERE ELEVATION IS LOCATED	L.L.O.	LONG LEG OUTSTANDING
	ELEVATION NUMBER	L.L.V.	LONG LEG VERTICAL
	SHEET NUMBER WHERE ELEVATION IS LOCATED	MAX.	MAXIMUM
	ELEVATION NUMBER	MECH.	MECHANICAL
	SHEET NUMBER WHERE ELEVATION IS LOCATED	MET.	METAL
	ELEVATION NUMBER	MEZZ.	MEZZANINE
	SHEET NUMBER WHERE ELEVATION IS LOCATED	M.I.	MISCELLANEOUS IRON
	ELEVATION NUMBER	MIN.	MINIMUM
	SHEET NUMBER WHERE ELEVATION IS LOCATED	MISC.	MISCELLANEOUS
	ELEVATION NUMBER	M.O.	MASONRY OPENING
	SHEET NUMBER WHERE ELEVATION IS LOCATED	N.I.C.	NOT IN CONTRACT
	ELEVATION NUMBER	N.T.S.	NOT TO SCALE
	SHEET NUMBER WHERE ELEVATION IS LOCATED	O.C.	ON CENTER
	ELEVATION NUMBER	O.D.	OUTSIDE DIAMETER
	SHEET NUMBER WHERE ELEVATION IS LOCATED	OPNG.	OPENING
	ELEVATION NUMBER	OPP.	OPPOSITE
	SHEET NUMBER WHERE ELEVATION IS LOCATED	PL.G.	PLATE GLASS
	ELEVATION NUMBER	PL.S.	PLATE STEEL
	SHEET NUMBER WHERE ELEVATION IS LOCATED	P.LAM.	PLASTER LAMINATE
	ELEVATION NUMBER	PLAS.	PLASTER
	SHEET NUMBER WHERE ELEVATION IS LOCATED	PREFAB.	PREFABRICATED
	ELEVATION NUMBER	PROJ.	PROJECT, PROJECTION
	SHEET NUMBER WHERE ELEVATION IS LOCATED	P.S.F.	POUNDS PER SQUARE FOOT
	ELEVATION NUMBER	PT.	POINT
	SHEET NUMBER WHERE ELEVATION IS LOCATED	R.	RISER
	ELEVATION NUMBER	R.A.	RETURN AIR
	SHEET NUMBER WHERE ELEVATION IS LOCATED	R.B.	RUBBER BASE
	ELEVATION NUMBER	R.C.	ROOF CONDUCTOR
	SHEET NUMBER WHERE ELEVATION IS LOCATED	R.C.P.	REFLECTED CEILING PLAN
	ELEVATION NUMBER	R.D.	ROOF DRAIN
	SHEET NUMBER WHERE ELEVATION IS LOCATED	R.F.	RUBBER FLOORING
	ELEVATION NUMBER	REINF.	REINFORCED, REINFORCING
	SHEET NUMBER WHERE ELEVATION IS LOCATED	REQ'D.	REQUIRED
	ELEVATION NUMBER	RFG.	ROOFING
	SHEET NUMBER WHERE ELEVATION IS LOCATED	RM.	ROOM
	ELEVATION NUMBER	R.S.	ROOF SUMP
	SHEET NUMBER WHERE ELEVATION IS LOCATED	R.T.	RUBBER TILE
	ELEVATION NUMBER	SAN.	SANITARY
	SHEET NUMBER WHERE ELEVATION IS LOCATED	SCHED.	SCHEDULE
	ELEVATION NUMBER	SHT.	SHEET
	SHEET NUMBER WHERE ELEVATION IS LOCATED	SIM.	SIMILAR
	ELEVATION NUMBER	SPEC.	SPECIFICATION
	SHEET NUMBER WHERE ELEVATION IS LOCATED	S.S.	SERVICE SINK
	ELEVATION NUMBER	STL.	STEEL
	SHEET NUMBER WHERE ELEVATION IS LOCATED	STD.	STANDARD
	ELEVATION NUMBER	STOR.	STORAGE
	SHEET NUMBER WHERE ELEVATION IS LOCATED	STRUCT.	STRUCTURAL
	ELEVATION NUMBER	SUSP.	SUSPENDED
	SHEET NUMBER WHERE ELEVATION IS LOCATED	SW.	SWITCH
	ELEVATION NUMBER	SYM.	SYMMETRICAL
	SHEET NUMBER WHERE ELEVATION IS LOCATED	T.	TREAD
	ELEVATION NUMBER	T&B	TOP AND BOTTOM
	SHEET NUMBER WHERE ELEVATION IS LOCATED	TEL.	TELEPHONE
	ELEVATION NUMBER	TERR.	TERRAZZO
	SHEET NUMBER WHERE ELEVATION IS LOCATED	T&G.	TONGUE AND GROOVE
	ELEVATION NUMBER	THK.	THICK, THICKNESS
	SHEET NUMBER WHERE ELEVATION IS LOCATED	THRES.	THRESHOLD
	ELEVATION NUMBER	T.O.S.	TOP OF STEEL
	SHEET NUMBER WHERE ELEVATION IS LOCATED	TYP.	TYPICAL
	ELEVATION NUMBER	U/C.	UNDERCUT
	SHEET NUMBER WHERE ELEVATION IS LOCATED	U.N.O.	UNLESS NOTED OTHERWISE
	ELEVATION NUMBER	V.B.	VINYL BASE
	SHEET NUMBER WHERE ELEVATION IS LOCATED	V.C.T.	VINYL COMPOSITION TILE
	ELEVATION NUMBER	V.I.F.	VERIFY IN FIELD
	SHEET NUMBER WHERE ELEVATION IS LOCATED	W.	WIDE
	ELEVATION NUMBER	VERT.	VERTICAL
	SHEET NUMBER WHERE ELEVATION IS LOCATED	WAINS.	WAINSCOT
	ELEVATION NUMBER	W.C.	WATER CLOSET
	SHEET NUMBER WHERE ELEVATION IS LOCATED	WD.WIN.	WOOD WINDOW
	ELEVATION NUMBER	WT.	WEIGHT
	SHEET NUMBER WHERE ELEVATION IS LOCATED	W.W.F.	WELDED WIRE FABRIC

MATERIAL LEGEND	
	ACOUSTICAL CEILING
	BATTLOOSE INSULATION
	BLOCKING/ROUGH LUMBER
	CONCRETE
	FINISHED WOOD
	GLASS
	GYPSON WALLBOARD
	MASONRY
	PARTICLE BOARD
	PLYWOOD

**ARCHITECT:**  
**4545 architecture**  
2761 E. JEFFERSON AVE  
STE 302  
DETROIT, MI 48207  
P. 313.454.4545  
TIM.FLINTOFF@4545ARCHITECTURE.COM

**CONSULTANT:**

Project :  
**708 PALLISTER  
HDC RENOVATION**

Issued for :  
**HDC SUBMIT 02/18/2025**

State of Michigan Seal:  
TIMOTHY R. FLINTOFF JR.  
ARCHITECT  
No. 1301084083  
LICENSED ARCHITECT

Drawn by :  
**ANJ**

Check by :  
**TRF**

Sheet Title :  
**TITLE SHEET,  
SHEET INDEX, AND  
CODE INFORMATION**

Project No. :  
**2024001**

Sheet No. :  
**TS1.1**

DO NOT SCALE DRAWINGS | ©2024 Timothy Flintoff Architect, PLLC

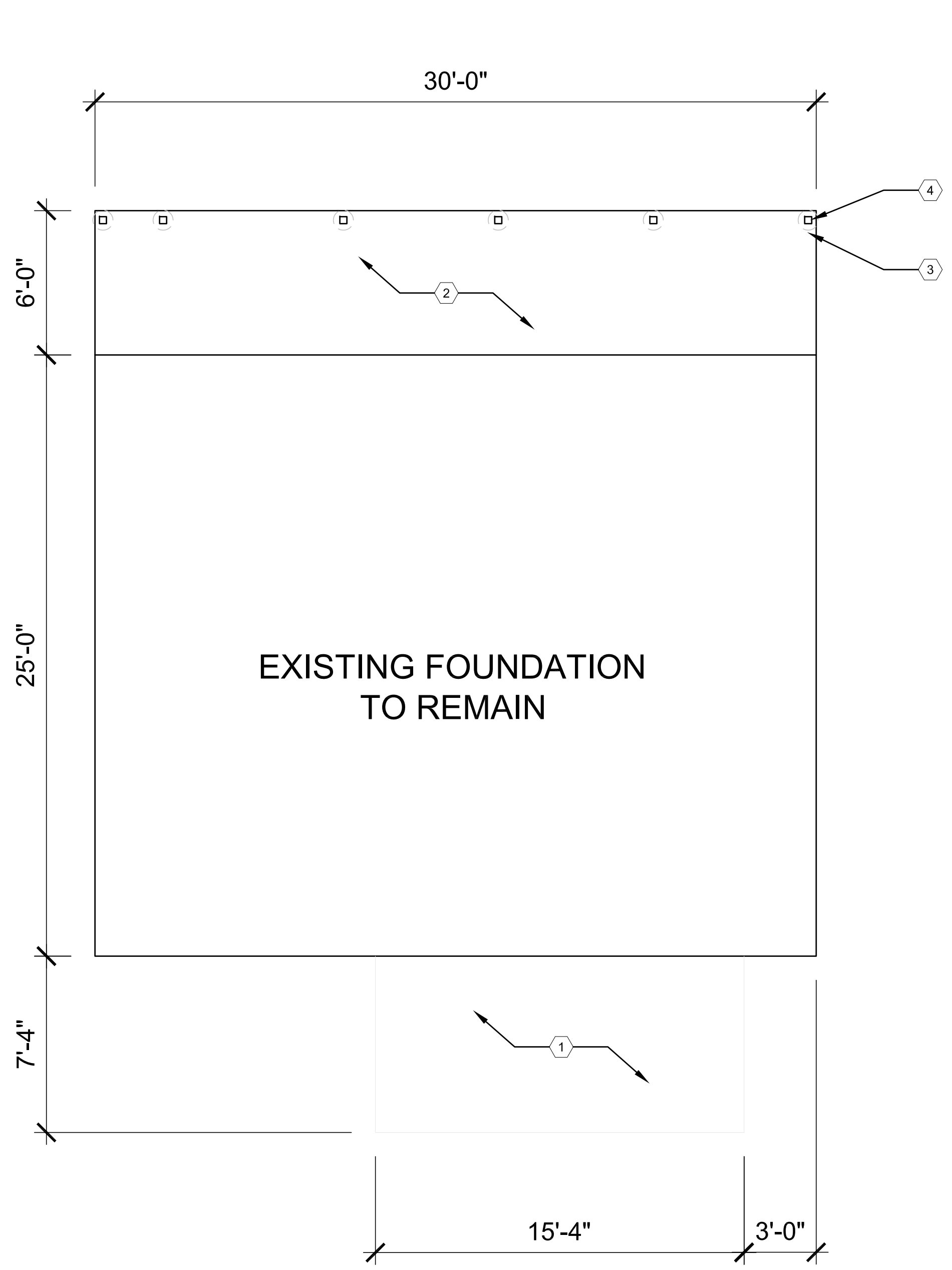

**FOUNDATION PLAN**  
SCALE: 1/4"=1'-0"

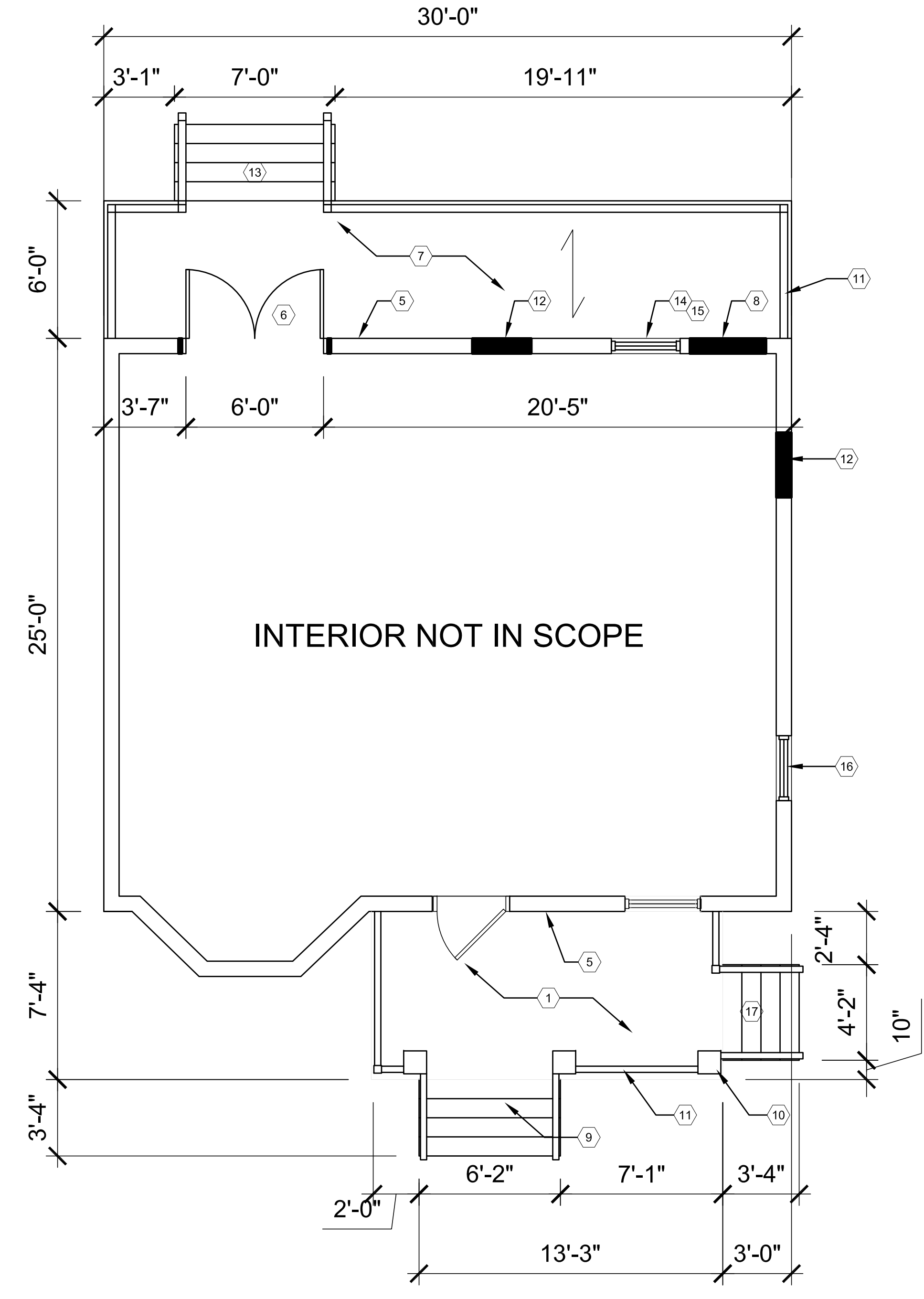

**FIRST FLOOR PLAN**  
SCALE: 1/4"=1'-0"

**GENERAL FLOOR PLAN NOTES:**

1. THIS DRAWING IS DIAGRAMMATIC AND SHOULD BE USED TO DETERMINE THE DESIGN INTENT. THE CONTRACTOR IS RESPONSIBLE FOR THE COMPLETE SET OF WORK AS INDICATED AND SHALL FIELD VERIFY ALL WORK, COORDINATE ALL DRAWINGS / NEW WORK AND SHALL NOTIFY ARCHITECT IMMEDIATELY OF ANY DISCREPANCIES IN THE DOCUMENTS BEFORE PROCEEDING. FAILURE TO DO SO WILL RESULT IN THE CONTRACTOR TAKING FULL RESPONSIBILITY AND LIABILITY FOR SAID DISCREPANCIES.
2. ALL DIMENSIONS ARE SHOWN FROM FINISH FACE TO FINISH FACE OF PARTITION UNLESS OTHERWISE NOTED.
3. WALL THICKNESS' ARE NOMINAL NOT ACTUAL DIMENSIONS. SEE WALL SCHEDULE FOR ACTUAL DIMENSIONS.
4. ALL WORK SHALL BE DONE IN ACCORDANCE WITH ALL LOCAL, STATE, COUNTY CODE REGULATIONS, O.S.H.A., AND THE AMERICAN WITH DISABILITIES ACT (ADA). REFER TO THE CODE PLAN FOR MORE INFORMATION.
5. PROVIDE POSITIVE SLOPE TO ALL FLOOR DRAINS WHILE KEEPING FLOOR LEVEL AT WALL BASE CONDITION.

**PLAN KEY NOTES:**  
(TYPICAL THIS SHEET ONLY)

- 1 EXISTING MASONRY PORCH TO REMAIN
- 2 NEW DECK FOOTPRINT
- 3 10" SONOTUBE (TYP.), B.O.F. TO BE MIN. 42" BELOW GRADE
- 4 4x4 WOOD POST (TYP.)
- 5 LEDGER DECK TO HOUSE, USING STRUCTURAL EPOXY AS REQ'D, STAGGER BOLTS 12" T & B
- 6 INSTALL NEW FRENCH DOOR (WORK COMPLETED), SEE ELEVATIONS. INFILL WALL AS REQ'D.
- 7 TREX COMPOSITE DECKING ON 2x8 WOOD DECK JOISTS, MAX 16" O.C.
- 8 REMOVE AND INFILL EXISTING DOOR (WORK COMPLETED)
- 9 NEW MASONRY STAIR (WORK COMPLETED)
- 10 WOOD WRAPPED 4x4 WOOD POSTS, SEE ELEVATIONS
- 11 NEW HANDRAIL, MIN. 36" TALL, SEE ELEVATIONS.
- 12 EXISTING WINDOW REMOVED/INFILLED (WORK COMPLETED), SEE ELEVATIONS
- 13 NEW TREX COMPOSITE STAIR
- 14 EXISTING WINDOW REPLACED WITH VINYL-CLAD SLIDING WINDOW (WORK COMPLETED)
- 15 SLIDING WINDOW TO BE REMOVED, REPLACED WITH ALUMINUM-CLAD WOOD SINGLE-HUNG WINDOW (ANDERSON 400 SERIES) W/ SIMULATED DIVIDED LITES TO MATCH PREVIOUSLY EXISTING WINDOW; PAINTED BLACK
- 16 INSTALL NEW VINYL-CLAD WOOD SINGLE-HUNG WINDOW (ANDERSON 400 SERIES), PAINTED BLACK; SEE ELEVATIONS (WORK COMPLETED)
- 17 REPLACE DAMAGED MASONRY STAIR; NEW STAIR TO MATCH EXISTING (WORK COMPLETED)

<p>ARCHITECT:</p> <p><b>4545</b> architecture</p> <p>2761 E. JEFFERSON AVE STE 302 DETROIT, MI 48207 P. 313.454.4545 TIM.FLINTOFF@4545ARCHITECTURE.COM</p>
<p>CONSULTANT:</p>
<p>Project :</p> <p><b>708 PALLISTER HDC RENOVATION</b></p>
<p>Issued for :</p> <p><b>HDC SUBMIT 02/18/2025</b></p>
<p>Drawn by : ANJ</p> <p>Check by : TRF</p>
<p>Sheet Title : <b>FOUNDATION AND FIRST FLOOR PLANS</b></p>
<p>Project No. : <b>2024001</b></p>
<p>Sheet No. : <b>A1.1</b></p>

DO NOT SCALE DRAWINGS | ©2024 Timothy Flintoff Architect, PLLC

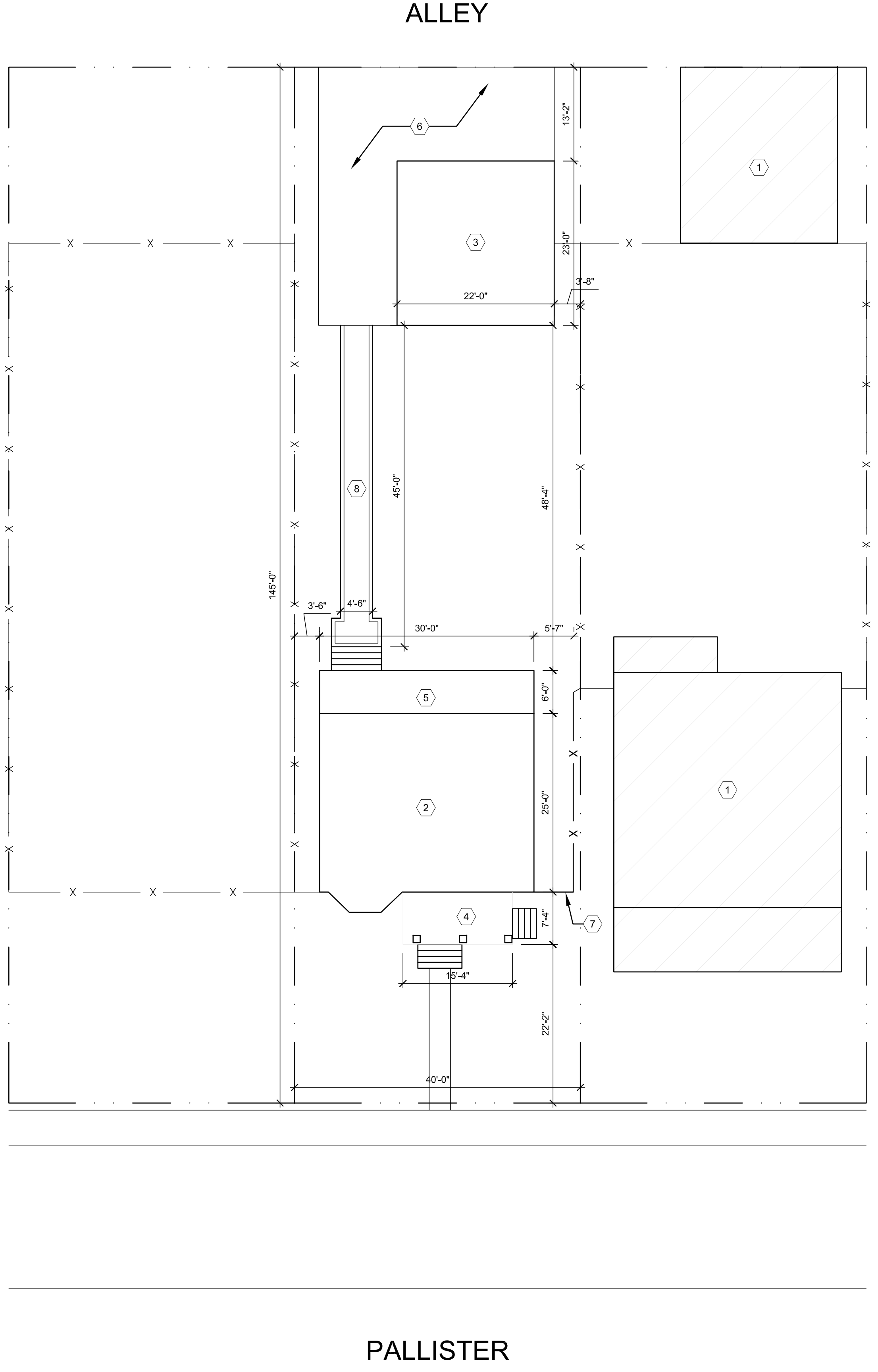

GENERAL SITE PLAN NOTES:

- PAVEMENT SHALL BE OF THE TYPE, THICKNESS AND CROSS SECTION AS INDICATED ON THE PLANS AND AS FOLLOWS:
- CONCRETE: PORTLAND CEMENT TYPE IA (AIR-ENTRAINED) WITH A MINIMUM CEMENT CONTENT OF SIX SACKS PER CUBIC YARD, MINIMUM 28 DAY COMPRESSIVE STRENGTH OF 3,500 PSI AND A SLUMP OF 1 1/2 TO 3 INCHES.
- ASPHALT: BASE COURSE - MDOT BITUMINOUS MIXTURE NO. 1100L, 20AA; SURFACE COURSE - MDOT BITUMINOUS MIXTURE NO. 1100T, 20AA; ASPHALT CEMENT PENETRATION GRADE 85-100, BOND COAT - MDOT SS-1H EMULSION AT 0.10 GALLON PER SQUARE YARD; MAXIMUM 2 INCH LIFT.
- PAVEMENT BASE SHALL BE COMPACTED TO 95% OF THE MAXIMUM DENSITY (MODIFIED PROCTOR) PRIOR TO PLACEMENT OF PROPOSED PAVEMENT. EXISTING SUB-BASE SHALL BE PROOF-ROLLED IN THE PRESENCE OF THE ENGINEER TO DETERMINE STABILITY.
- ALL CONCRETE PAVEMENT, DRIVEWAYS, CURB & GUTTER, ETC., SHALL BE SPRAY CURED WITH WHITE MEMBRANE CURING COMPOUND IMMEDIATELY FOLLOWING FINISHING OPERATION.
- ALL CONCRETE PAVEMENT JOINTS SHALL BE FILLED WITH HOT POURED RUBBERIZED ASPHALT JOINT SEALING COMPOUND IMMEDIATELY AFTER SAWCUT OPERATION. FEDERAL SPECIFICATION SS-S164.
- ALL WORKMANSHIP AND MATERIALS SHALL BE IN ACCORDANCE WITH THE CURRENT STANDARDS AND SPECIFICATIONS OF THE MUNICIPALITY AND THE MICHIGAN DEPARTMENT OF TRANSPORTATION STANDARD SPECIFICATIONS FOR CONSTRUCTION, CURRENT EDITION.
- ALL TOP OF CURB ELEVATIONS, AS SHOWN ON THE PLANS, ARE CALCULATED FOR A 6" CONCRETE CURB UNLESS OTHERWISE NOTED.
- ALL SIDEWALK RAMPS, CONFORMING TO PUBLIC ACT NO. 8, 1993, SHALL BE INSTALLED AS INDICATED ON THE PLANS.
- CONSTRUCTION OF A NEW OR RECONSTRUCTED DRIVE APPROACH CONNECTING TO AN EXISTING STATE OR COUNTY ROADWAY SHALL BE ALLOWED ONLY AFTER AN APPROVED PERMIT HAS BEEN SECURED FROM THE AGENCY HAVING JURISDICTION OVER SAID ROADWAY.
- FOR ANY WORK WITHIN THE PUBLIC RIGHT-OF-WAY, THE CONTRACTOR SHALL PAY FOR AND SECURE ALL NECESSARY PERMITS AND LIKEWISE ARRANGE FOR ALL INSPECTION.
- EXISTING TOPSOIL, VEGETATION AND ORGANIC MATERIALS SHALL BE STRIPPED AND REMOVED FROM PROPOSED PAVEMENT AREA PRIOR TO PLACEMENT OF BASE MATERIALS.
- EXPANSION JOINTS SHOULD BE INSTALLED AT THE END OF ALL INTERSECTION RADII.
- SIDEWALK RAMPS, CONFORMING TO PUBLIC ACT NO. 8, 1973, SHALL BE INSTALLED AS SHOWN AT ALL STREET INTERSECTIONS AND AT ALL BARRIER FREE PARKING AREAS AS INDICATED ON THE PLANS.
- ALL PAVEMENT AREAS SHALL BE PROOF-ROLLED UNDER THE SUPERVISION OF A GEOTECHNICAL ENGINEER PRIOR TO THE PLACEMENT OF BASE MATERIALS AND PAVING MATERIALS.
- FILL AREAS SHALL BE MACHINE COMPACTED IN UNIFORM LIFTS NOT EXCEEDING 9 INCHES THICK TO 98% OF THE MAXIMUM DENSITY (MODIFIED PROCTOR) PRIOR TO PLACEMENT OF PROPOSED PAVEMENT.
- ALL LANDSCAPED AREAS TO BE PROVIDED W/ SPRINKLER SYSTEMS FOR 100% COVERAGE.

SITE PLAN KEY NOTES:

- (TYPICAL THIS SHEET ONLY)
- 1 EXISTING BUILDING NOT IN SCOPE
  - 2 EXISTING HOUSE
  - 3 EXISTING GARAGE
  - 4 EXISTING FRONT PORCH
  - 5 NEW REAR DECK
  - 6 EXISTING CONCRETE PARKING PAD
  - 7 NEW WOOD FENCE WITH GATE
  - 8 NEW PAVED WALKWAY

<p>ARCHITECT:</p> <p><b>4545</b> architecture</p> <p>2761 E. JEFFERSON AVE STE 302 DETROIT, MI 48207 P. 313.454.4545 TIM.FLINTOFF@4545ARCHITECTURE.COM</p>
<p>CONSULTANT:</p>
<p>Project :</p> <p><b>708 PALLISTER HDC RENOVATION</b></p>
<p>Issued for :</p> <p><b>HDC SUBMIT 02/18/2025</b></p>
<p>Drawn by : <b>ANJ</b></p> <p>Check by : <b>TRF</b></p>
<p>Sheet Title : <b>ARCHITECTURAL SITE PLAN</b></p>
<p>Project No. : <b>2024001</b></p>
<p>Sheet No. : <b>SP1.1</b></p>

DO NOT SCALE DRAWINGS | ©2024 Timothy Flintoff Architect, PLLC

**GENERAL FLOOR PLAN NOTES:**

1. THIS DRAWING IS DIAGRAMMATIC AND SHOULD BE USED TO DETERMINE THE DESIGN INTENT. THE CONTRACTOR IS RESPONSIBLE FOR THE COMPLETE SET OF WORK AS INDICATED AND SHALL FIELD VERIFY ALL WORK, COORDINATE ALL DRAWINGS / NEW WORK AND SHALL NOTIFY ARCHITECT IMMEDIATELY OF ANY DISCREPANCIES IN THE DOCUMENTS BEFORE PROCEEDING. FAILURE TO DO SO WILL RESULT IN THE CONTRACTOR TAKING FULL RESPONSIBILITY AND LIABILITY FOR SAID DISCREPANCIES.
2. ALL DIMENSIONS ARE SHOWN FROM FINISH FACE TO FINISH FACE OF PARTITION UNLESS OTHERWISE NOTED.
3. WALL THICKNESS' ARE NOMINAL NOT ACTUAL DIMENSIONS. SEE WALL SCHEDULE FOR ACTUAL DIMENSIONS.
4. ALL WORK SHALL BE DONE IN ACCORDANCE WITH ALL LOCAL, STATE, COUNTY CODE REGULATIONS, O.S.H.A., AND THE AMERICAN WITH DISABILITIES ACT (ADA). REFER TO THE CODE PLAN FOR MORE INFORMATION.
5. PROVIDE POSITIVE SLOPE TO ALL FLOOR DRAINS WHILE KEEPING FLOOR LEVEL AT WALL BASE CONDITION.

**DEMO PLAN KEY NOTES:**

- (TYPICAL THIS SHEET ONLY)
- 1 WINDOW REMOVED AND REPLACED, SEE ELEVATIONS
  - 2 WINDOW REMOVED AND REPLACED WITH DOOR, SEE ELEVATIONS
  - 3 DEMOLISHED EXISTING REAR DECK AND STAIR
  - 4 REMOVED AND INFILLED REAR DOOR, SEE ELEVATIONS
  - 5 DEMOLISHED & REPLACED EXISTING MASONRY STAIR
  - 6 DEMOLISHED CHIMNEY
  - 7 REMOVED ROOF AS REQ'D FOR NEW DORMER
  - 8 LINE OF WALLS BELOW
  - 9 EXISTING COLUMNS REMOVED, REPLACED (SEE ELEVATIONS)
  - 10 WINDOW REMOVED, WALL INFILLED
  - 11 WALL DEMOLISHED AS REQ'D FOR NEW WINDOW

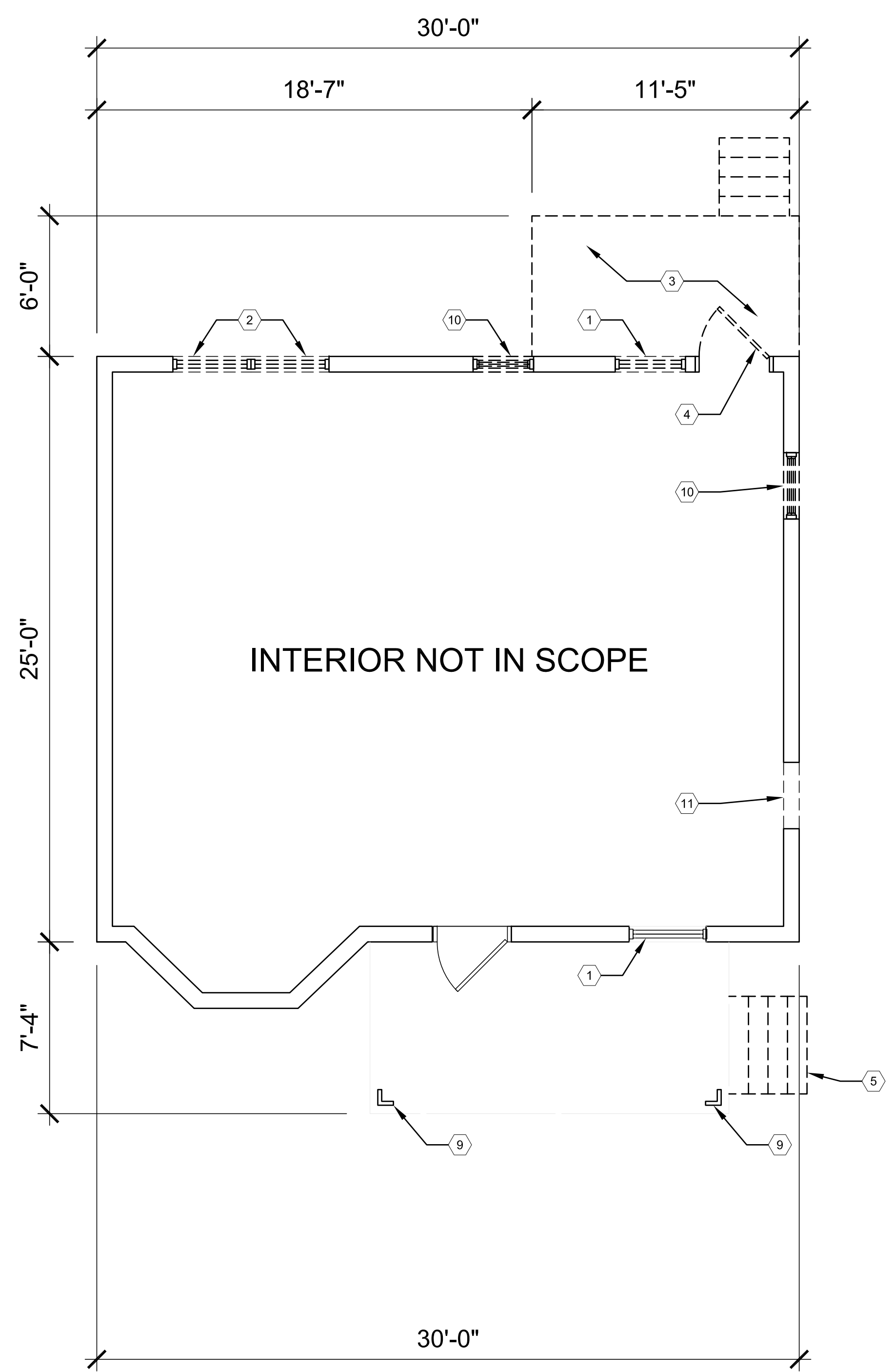

**DEMO FIRST FLOOR PLAN**  
SCALE: 1/4"=1'-0"

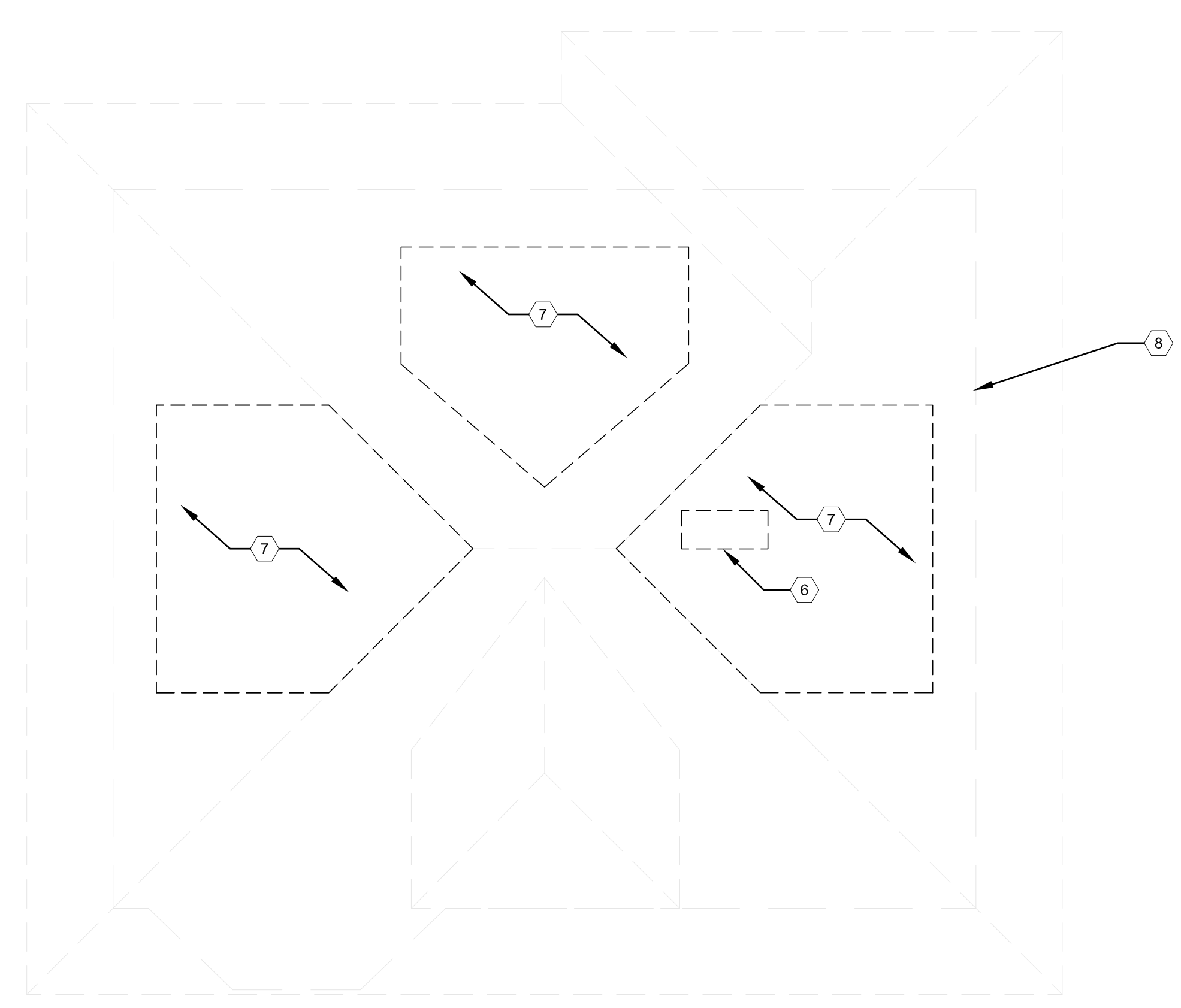

**DEMO ROOF PLAN**  
SCALE: 1/4"=1'-0"

ARCHITECT: <b>4545 architecture</b> 2761 E. JEFFERSON AVE STE 302 DETROIT, MI 48207 P. 313.454.4545 TIM.FLINTOFF@4545ARCHITECTURE.COM	
CONSULTANT:	
Project :	
708 PALLISTER HDC RENOVATION	
Issued for :	
HDC SUBMIT 02/18/2025	
Drawn by :	ANJ
Check by :	TRF
Sheet Title :	DEMO PLANS
Project No. :	2024001
Sheet No. :	<b>D1.1</b>

DO NOT SCALE DRAWINGS | ©2024 Timothy Flintoff Architect, PLLC

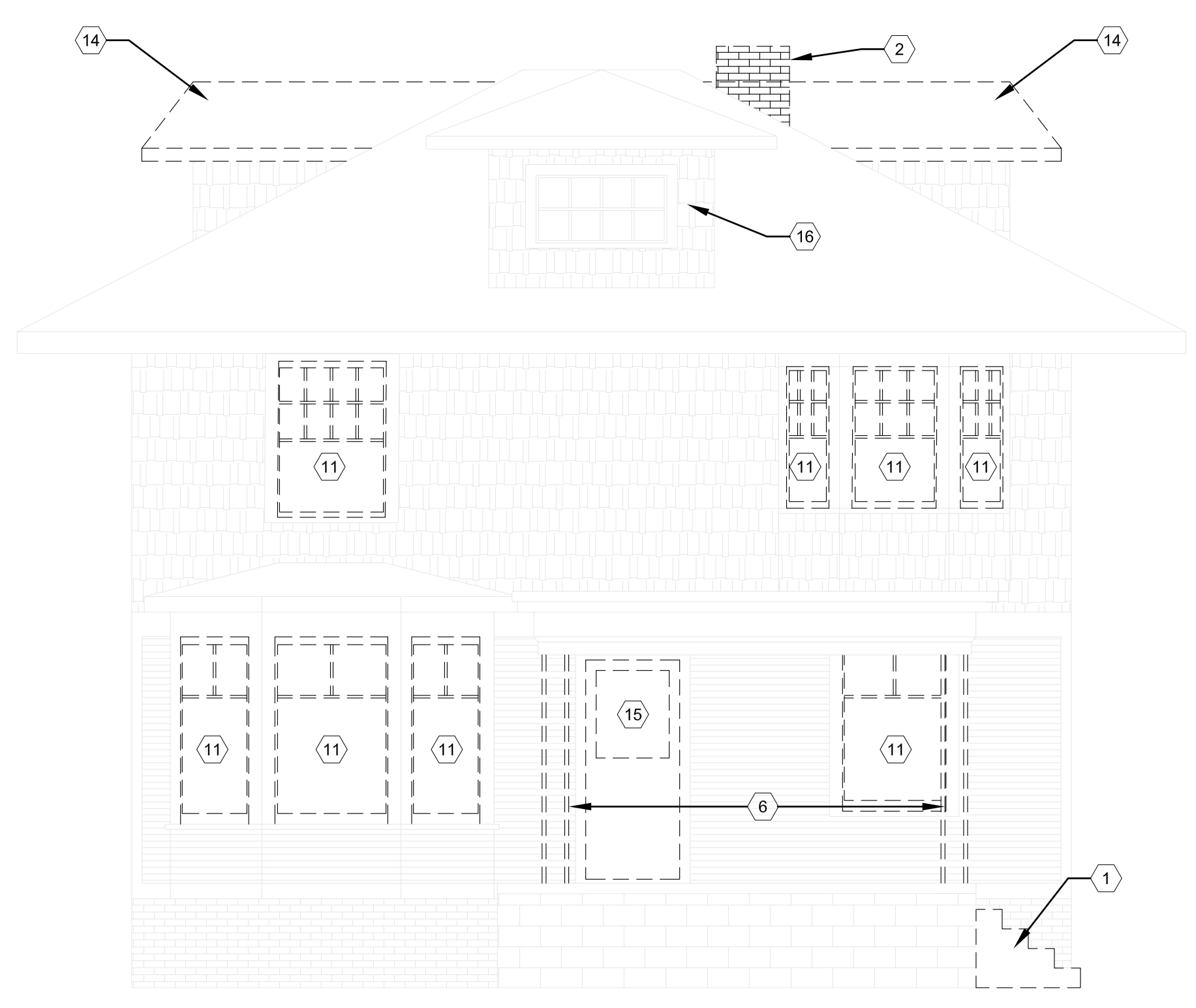

1 SOUTH ELEVATION  
A1.1 SCALE: 1/4" = 1'-0"

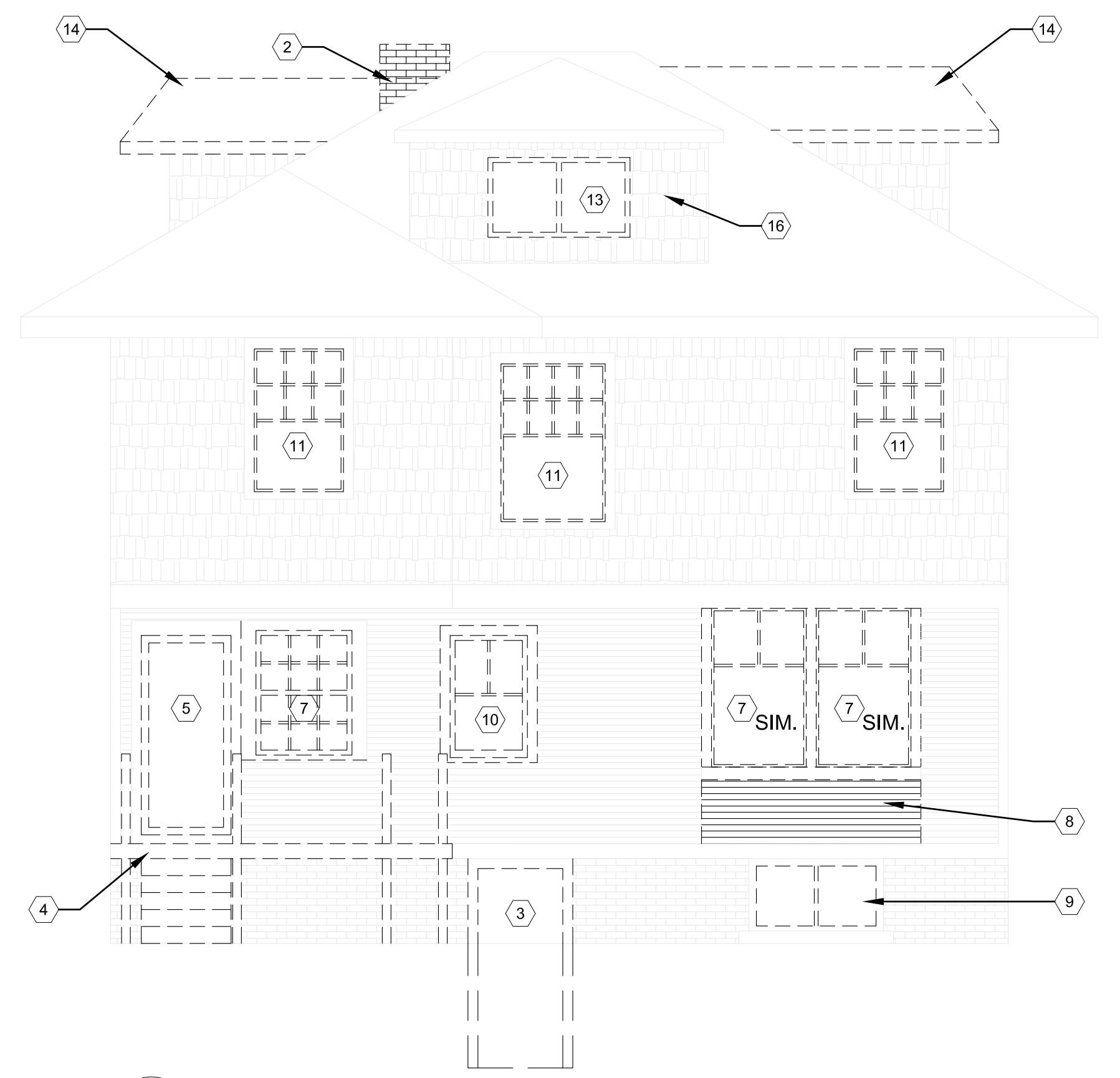

2 NORTH ELEVATION  
A1.1 SCALE: 1/4" = 1'-0"

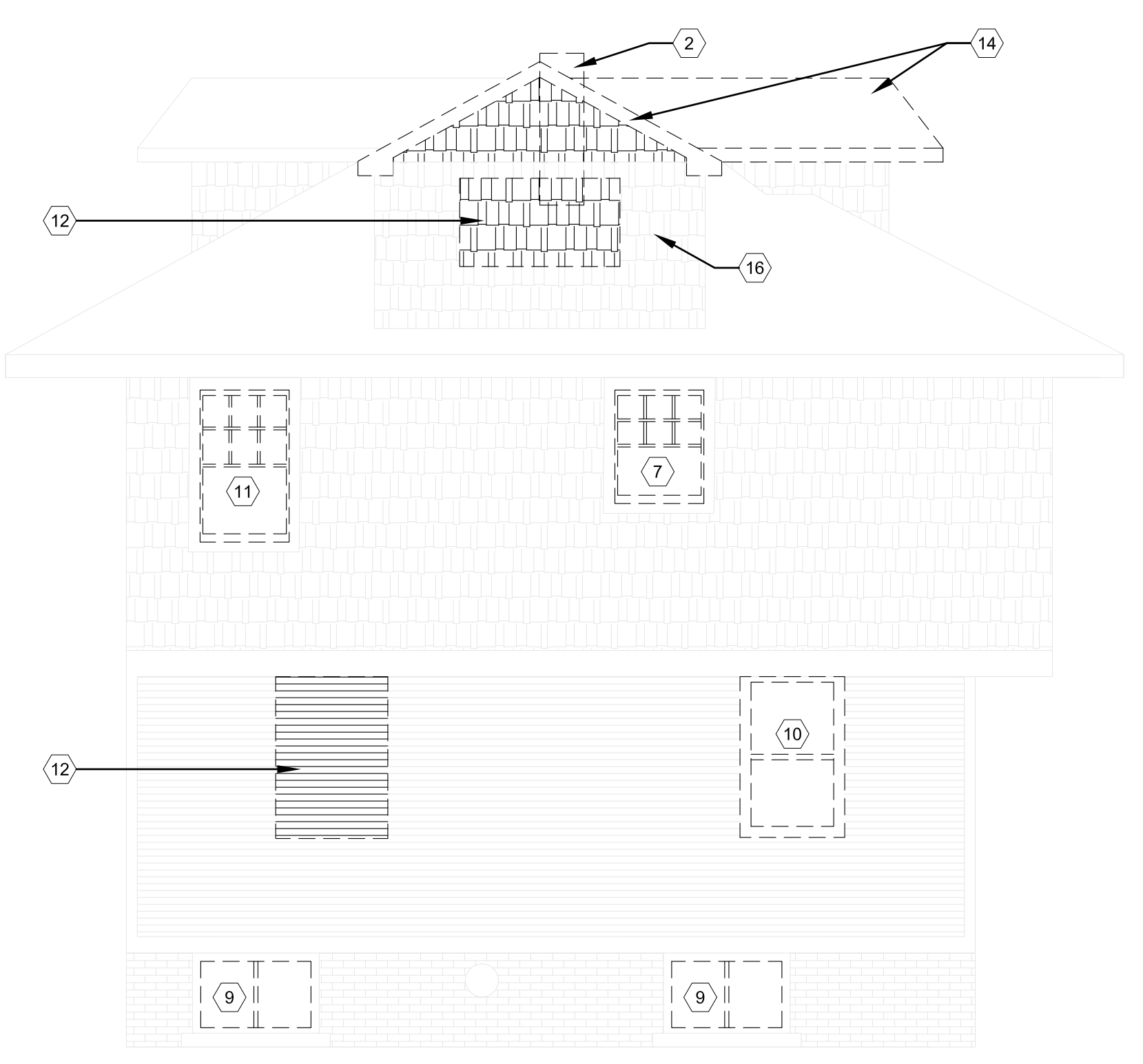

3 EAST ELEVATION  
A1.1 SCALE: 1/4" = 1'-0"

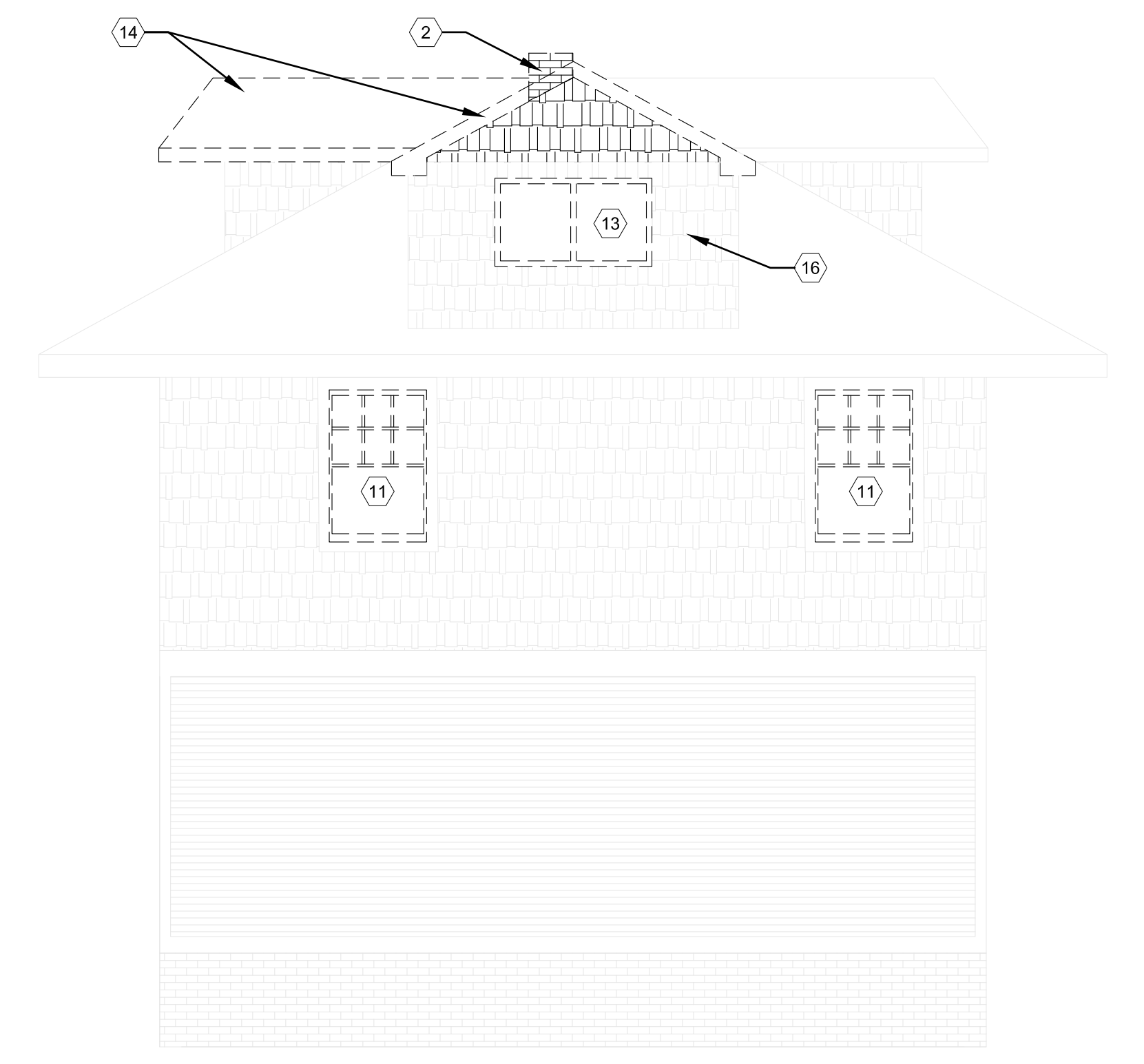

4 WEST ELEVATION  
A1.1 SCALE: 1/4" = 1'-0"

**ELEVATION KEY NOTES:**

- (TYPICAL THIS SHEET ONLY)
- 1 MASONRY STAIRS REMOVED, REPLACED
  - 2 CHIMNEY DEMOLISHED
  - 3 EXISTING BASEMENT DOOR REMOVED, WALL INFILLED; USE IN-KIND MATERIALS FOR EXTERIOR CLADDING. EARTH TO BE INFILLED
  - 4 REAR DECK AND STAIR DEMOLISHED
  - 5 DOOR REMOVED, WALL INFILLED; USE IN-KIND MATERIALS FOR EXTERIOR CLADDING
  - 6 EXISTING COLUMNS TO BE REMOVED AND REPLACED; SHORE ROOF AS REQ'D
  - 7 EXISTING WINDOW REMOVED AND REPLACED, SEE EXTERIOR ELEVATIONS
  - 8 WALL REMOVED FOR NEW DOOR, SEE EXTERIOR ELEVATIONS
  - 9 BASEMENT WINDOWS REMOVED, REPLACED WITH GLASS BLOCK; SEE EXTERIOR ELEVATIONS
  - 10 WINDOW REMOVED, WALL INFILLED; SEE EXTERIOR ELEVATIONS
  - 11 EXISTING SINGLE-HUNG WINDOW REMOVED, REPLACED W/ VINYL-CLAD WOOD SINGLE-HUNG WINDOW (ANDERSON 400 SERIES) (WORK COMPLETED); TO BE PAINTED BLACK
  - 12 WALL DEMOLISHED AS REQ'D FOR NEW WINDOW
  - 13 SLIDING WINDOW TO BE REMOVED, REPLACED (SEE EXTERIOR ELEVATIONS)
  - 14 DORMER ROOF TO BE REMOVED, REPLACED (SEE EXTERIOR ELEVATIONS)
  - 15 ENTRY DOOR REMOVED, REPLACED
  - 16 REMOVE INSTALLED COMPOSITE SIDING

ARCHITECT:

**4545** architecture

2761 E. JEFFERSON AVE  
STE 302  
DETROIT, MI 48207  
P. 313.454.4545  
TIM.FLINTOFF@4545ARCHITECTURE.COM

CONSULTANT:

Project :

**708 PALLISTER  
HDC RENOVATION**

Issued for :

**HDC SUBMIT 02/18/2025**

Timothy R. Flintoff Jr.  
ARCHITECT  
No. 1301064083  
LICENSED ARCHITECT

Drawn by :  
**TRF**

Check by :

Sheet Title :  
**DEMO EXTERIOR  
ELEVATIONS**

Project No. :  
**2024001**

Sheet No. :  
**D3.1**

DO NOT SCALE DRAWINGS | ©2024 Timothy Flintoff Architect, PLLC