

NOTE: Based on the scope of work, additional documentation may be required. See www.detroitmi.gov/hdc for scope-specific requirements.

PROJECT DETAILS – TELL US ABOUT YOUR PROJECT

Instructions: Add project details using the text box in each section. If your details exceed the space provided, attach the details via the attachment icon for that section.

ePLANS PERMIT NUMBER:

(only applicable if you've already applied for permits through ePLANS)

N/A

GENERAL

1. DESCRIPTION OF EXISTING CONDITION

Please tell us about the current appearance and conditions of the areas you want to change. You may use a few sentences or attach a separate prepared document on the right. (For example, "existing roof on my garage is covered in gray asphalt shingles in poor condition.")

Empty residential lot with grass on it.



2. PHOTOGRAPHS

Help us understand your project. Please attach photographs of all areas where work is proposed.



3. DESCRIPTION OF PROJECT

In this box, tell us about what you want to do at the areas described above in box #1. (For example, "Install new asphalt shingle roofing at garage.")

Add a greenhouse to existing approved housing plans. The fencing will be at 2.44 meters high and would cover the lower portion of the greenhouse slightly above the height of the front doors. the top of the greenhouse is the only portion that will be visible.



4. DETAILED SCOPE OF WORK

In this box, please describe all steps necessary to complete the work described in box #3. (For example, "remove existing shingles, replace wood deck as necessary, replace wood eaves, install roof vents, replace rotted fascia boards, paint, clean worksite.")

Remove sod and 3 inches of soil. Compact soil and add an inch of gravel. Lay 4-inch slab on grade, 1200 sqft.
Assemble frame of greenhouse on SOG and install glass panels.
Install decorative fencing and brick/stucco post.



5. BROCHURES/CUT SHEETS

Please provide information on the products or materials you are proposing to install. For example, a brochure on the brand and color of the shingles proposed.



ADDITIONAL DETAILS

<p>9. OTHER <i>Please provide any additional details. HDC Staff may ask you to submit additional information at a later time depending on your project.</i></p>	

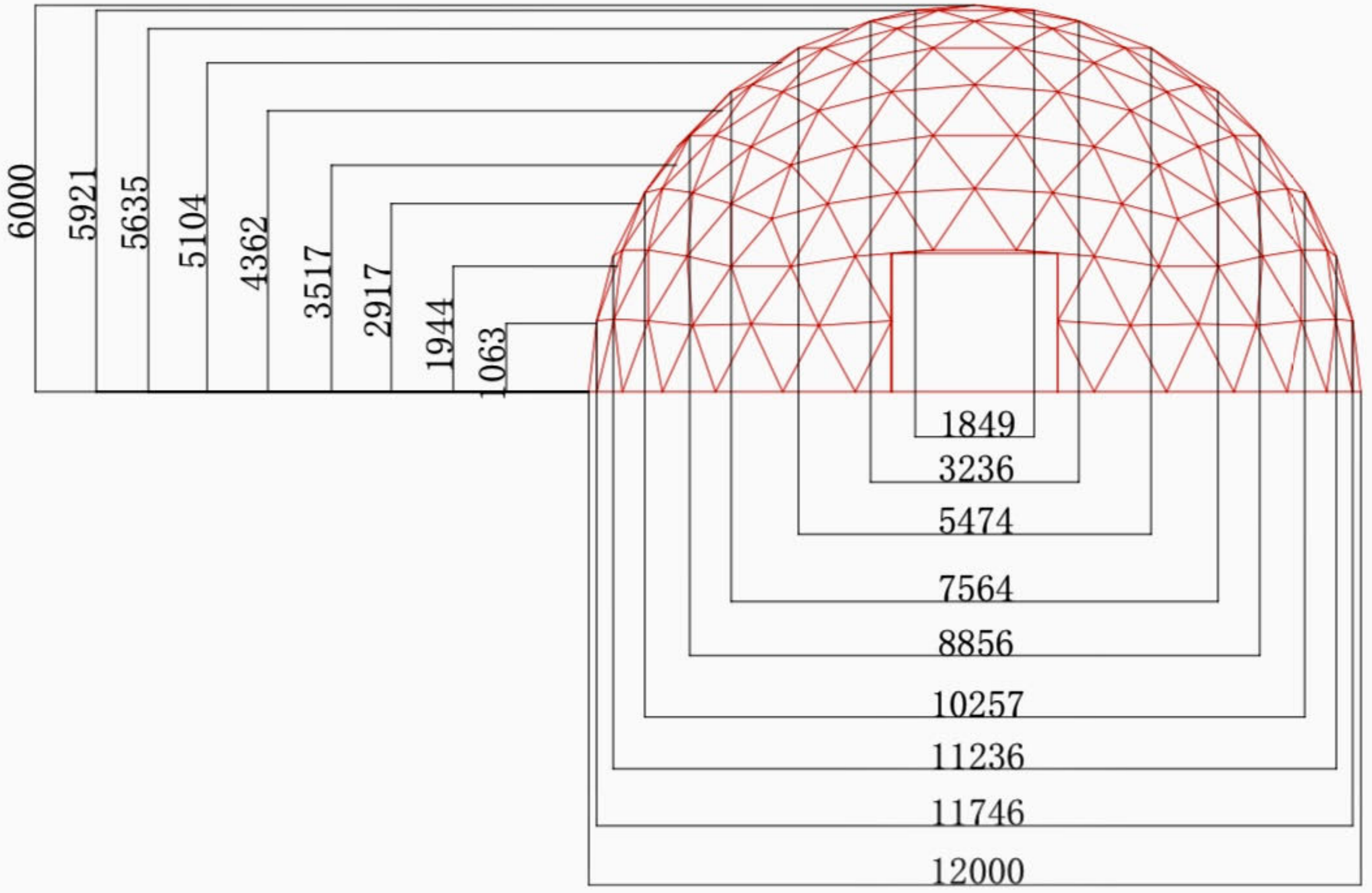

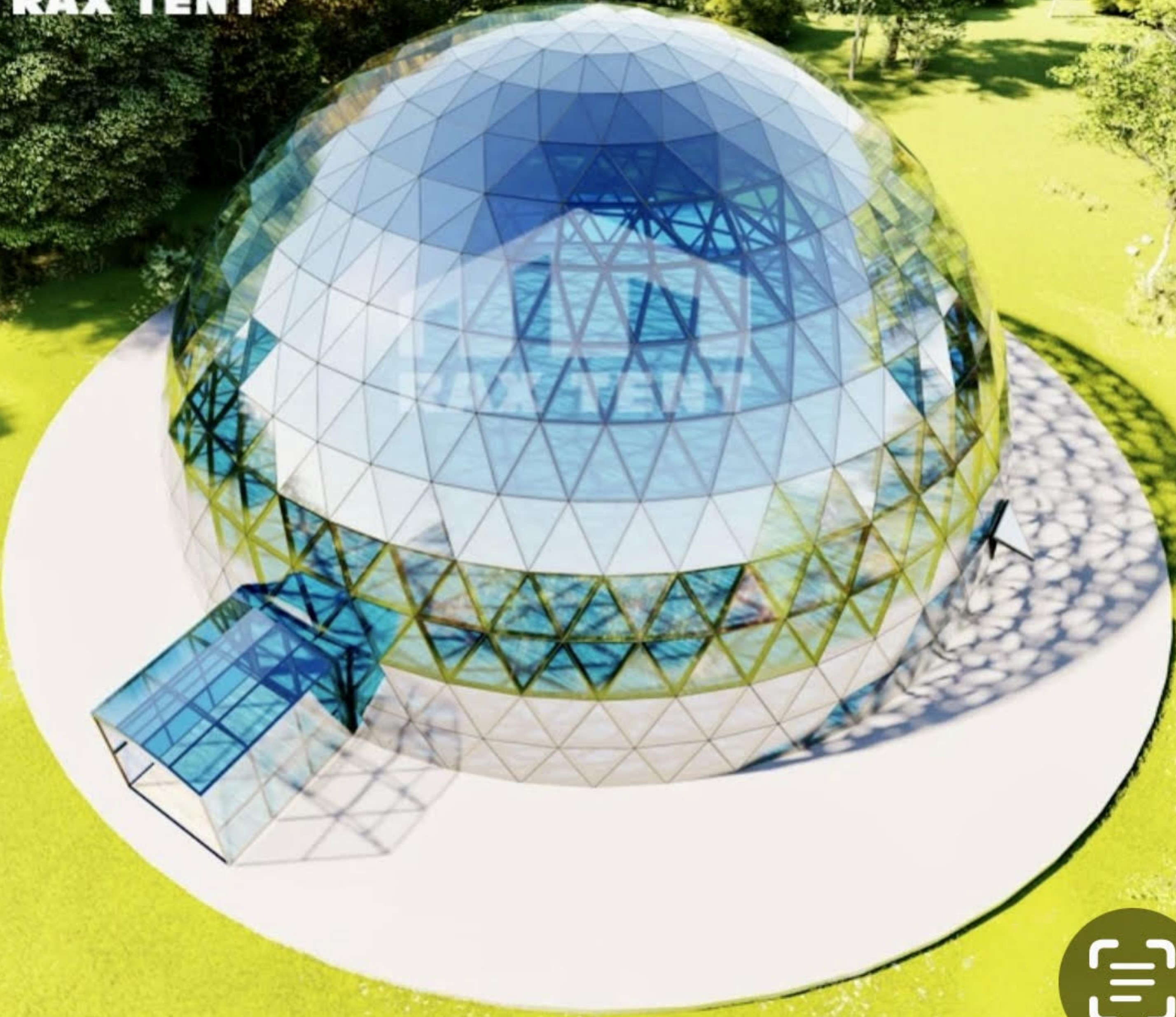



RAX TENT:0086-13822115092

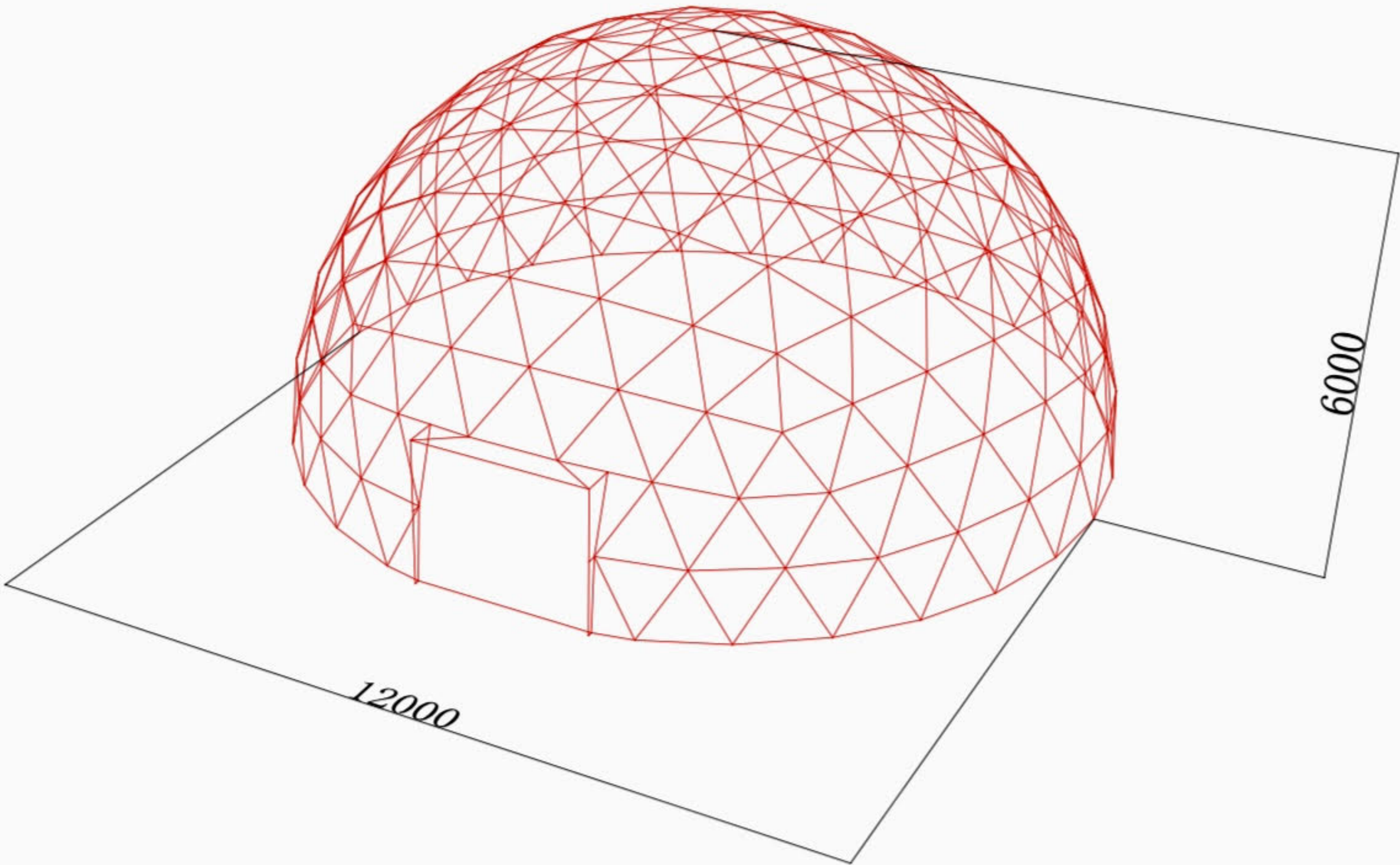

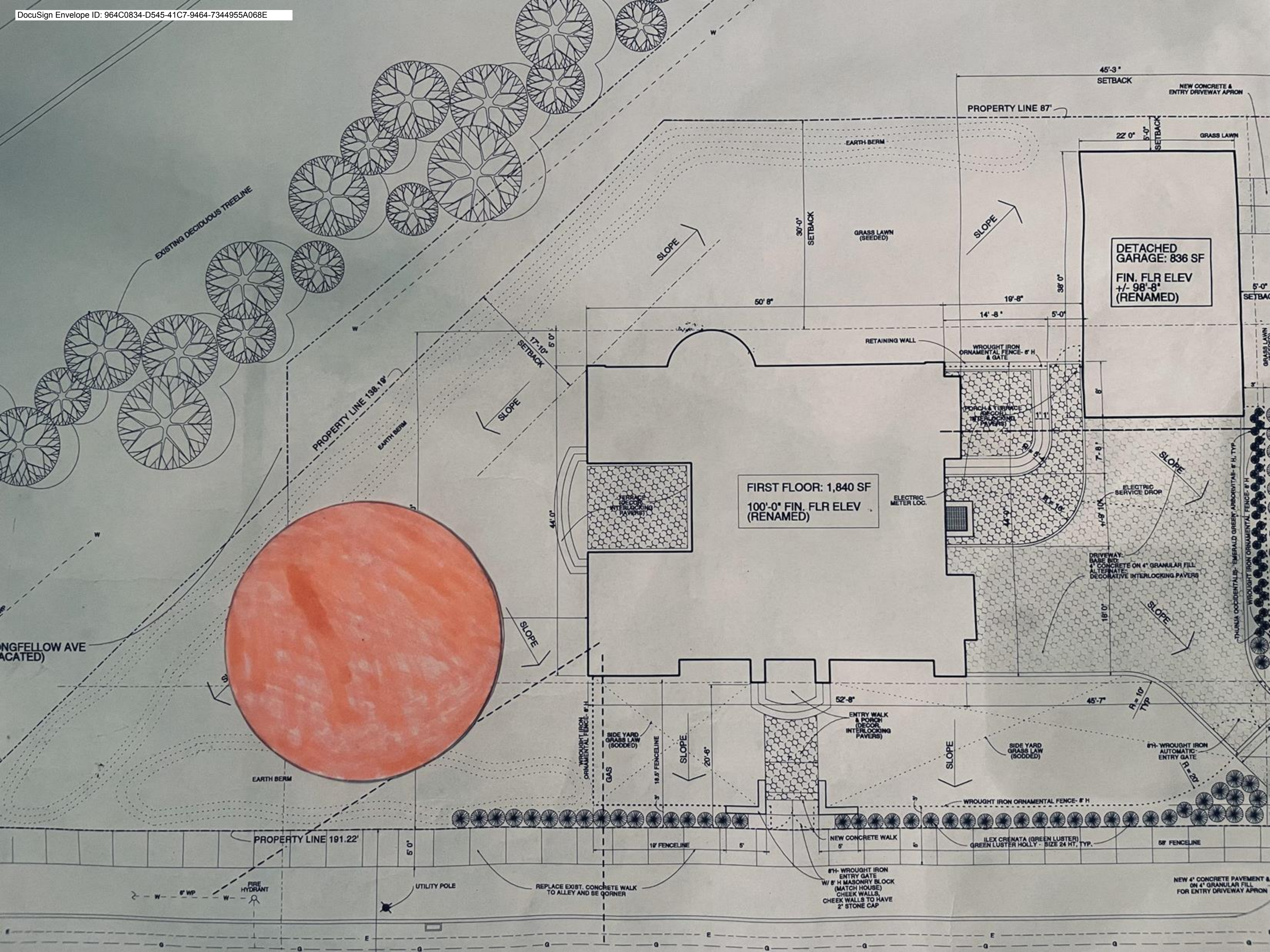

DETACHED GARAGE: 836 SF
FIN. FLR ELEV +/- 98'-8" (RENAMED)

FIRST FLOOR: 1,840 SF
100'-0" FIN. FLR ELEV (RENAMED)

EXISTING DECIDUOUS TREE LINE

PROPERTY LINE 138.18'

PROPERTY LINE 87'

PROPERTY LINE 191.22'

NGFELLOW AVE (ACATED)

NEW 4" CONCRETE PAVEMENT & ON 4" GRANULAR FILL FOR ENTRY DRIVEWAY APRON

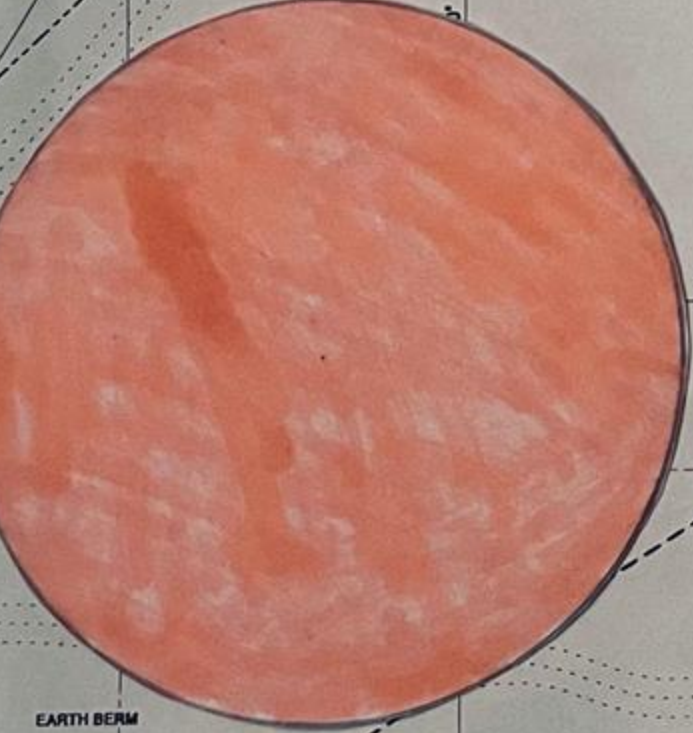



10

John C Lodge Fwy

10







广州市瑞立帐篷有限公司
Guangzhou Rax Tent Co.,Ltd





瑞立帐篷成立于2013年，主创团队已在行业深耕15年有余，是最早的一批帐篷制造商，拥有完善的技术/工程/销售/营销团队，提供专业产品的设计-制造-生产-销售-安装等一站式服务。

公司专注于球形帐篷，玻璃球形帐篷，酒店住宿体，定制款帐篷，活动帐篷等，出口达106个国家。

公司产品多为独家设计专利产品，拥有各项专利及出口认证，是国内球形帐篷制造商NO.1。

精益求精的追求产品的极致，坚持品质的重要性，坚持用心做好产品，坚持为中国的制造业品质负责，是我们一直在做的事情。

拥有丰富的项目案例，卓著的市场经验，欢迎您成为我们的合作伙伴，共同快速发展壮大！

RAXTENT was established in 2013, the main creative team has been in the tent industry for more than 15 years and we are the one of the earliest tent manufacturers with a complete technical /engineering / sales / marketing team, providing professional product design, manufacturing production, sales, installation and other one-stop services.

RAXTENT specializes in dome tents, glass dome tents, hotel tents, customized tents, event tents, etc. Our products have been exported to as many as 106 countries.

RAXTENT products are mostly exclusive design patented products, with various patents and export certifications, and we are the **No.1 Dome tent manufacturer in China.**

Pursuing the ultimate product, insisting on quality first, insisting on making products with heart, and insisting on being responsible for the quality of China's manufacturing industry are what we have been doing.

RAXTENT has the most successful project cases and outstanding market experience. Welcome to become our partner !! Keeping pace with the times and developing together with customers is our constant pursuit.

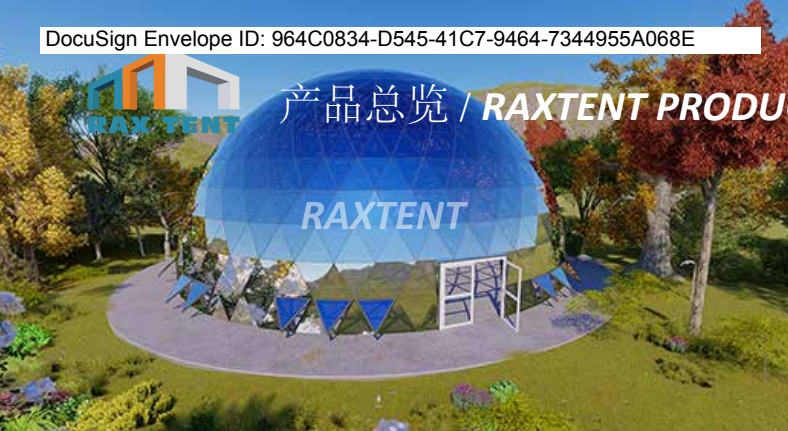

玻璃球帐篷 / **Glass Dome Tent**

尺寸: 3-20m直径 / Size from 3m to 20m in diameter



PVC布球帐篷 / **PVC Fabric Dome Tent**

尺寸: 3-80m直径 / Size from 3m to 80m in diameter



南瓜球帐篷 / **Pumpkin Tent**

尺寸: 6.5m直径 / Size: 6.5m diameter



金字塔玻璃帐篷 / **Pyramid Glass Tent**

尺寸: 6m,7M直径 / Size: 6M, 7M in diameter



桃型PVC帐篷 / **Zome PVC Dome Tent**

尺寸: 3m,4M,5M,6M直径 / Size: 3M,4M,5M,6M in diameter



桃型玻璃球帐篷 / **Zome Glass Dome Tent**

尺寸: 6M,7M直径 / Size : 6M, 7M in diameter



帽顶帐篷 / **Peak Tent**

尺寸: 30,60,90 m² / Size : 30, 60, 90sqm



混合型帐篷 / **MIX Dome Tent**

尺寸: 5-6-7m直径 / Size : 5-6-7m in diameter



贝壳帐篷 / **Cocoon Tent**

尺寸: 5x8m / Size : 5x8m



树屋 / **Tree Tent**

尺寸: 3m直径 / Size : 3M in diameter



玻璃球规格表 / GLASS DOME TENT Dimension Diagram

Glass Dome Tent Size List						
尺寸/m	面积/m ²	顶高/m	框架	覆盖层	抗风性	抗雪性
Size / m	Sqm	Roof height/m	Structure	Roof cover	Wind load(km/h)	Snow Load(Kn/sqm)
4	13 sqm	3.0	Aluminum	Tempered glass	120km/h	0.5
5	20 sqm	3.2	Aluminum	Tempered glass	120km/h	0.5
6	28 sqm	3.5	Aluminum	Tempered glass	120km/h	0.5
7	39 sqm	4.2	Aluminum	Tempered glass	120km/h	0.5
8	50 sqm	4.0	Aluminum	Tempered glass	120km/h	0.5
9	64 sqm	4.5	Aluminum	Tempered glass	120km/h	0.5
10	79 sqm	5.0	Aluminum	Tempered glass	120km/h	0.5
11	95 sqm	5.5	Aluminum	Tempered glass	120km/h	0.5
12	113 sqm	6.0	Aluminum	Tempered glass	120km/h	0.5
15	177 sqm	7.8	Aluminum	Tempered glass	120km/h	0.5
20	314 sqm	10.0	Aluminum	Tempered glass	120km/h	0.5

RAXTENT Aluminum Glass Dome Tent Material	
Aluminum Structure	Patented industrial aluminum alloy profiles, 6061T6/T5
Coted color of structure	Standard frame coated white or black or gray, 3 kinds to choose
	Customized color: golden, etc
Tempered Glass	Single layer glass 5mm
	Hollow glass 5+9A+5mm
	Laminated glass 5+0.75PVB +5mm
	Triplex glass
Glass Color	Blue / Green / Black / Grey / Clear / Wood / White / Sliver , etc.
Accessories	Exclusive design of insulation / curtain / Glass windows by hand / Electric glass window / Floor system
Steel components	Hot-dip galvanized steel, the thickness over 60um





玻璃球 / RAXTENT GLASS DOME TENT Accessories

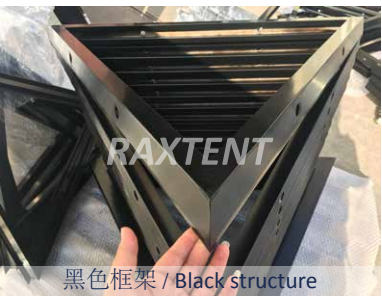

黑色框架 / Black structure

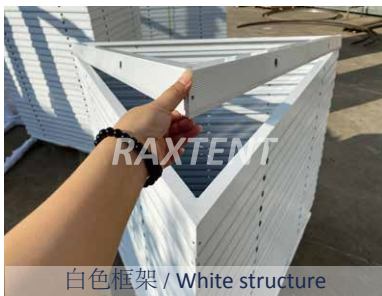

白色框架 / White structure

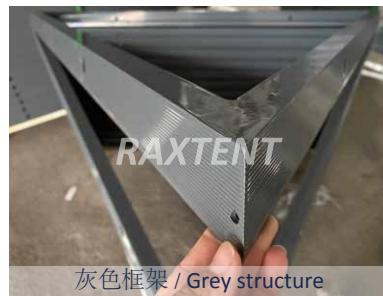

灰色框架 / Grey structure



金色框架 / Golden structure



玻璃颜色 / Tempered Glass color



中空玻璃 / Hollow glass

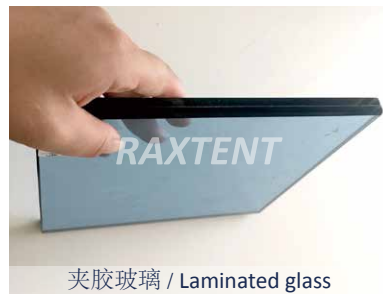

夹胶玻璃 / Laminated glass



玻璃门 / Glass Door



三角窗 / Glass window



保温层 / Insulation



豪华窗帘 / Luxury curtain



密码锁 / Password lock



室内地板 / Wood floor

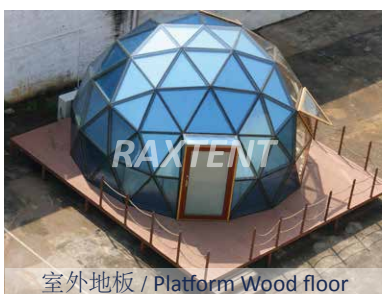

室外地板 / Platform Wood floor



洗手间 / Bathroom



清洁方式 / Clear Glass



玻璃球尺寸示意图 / GLASS DOME TENT Dimension Diagram

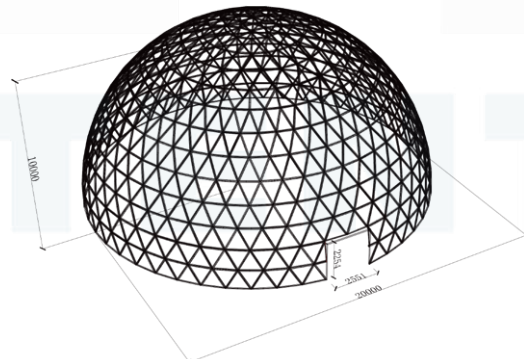
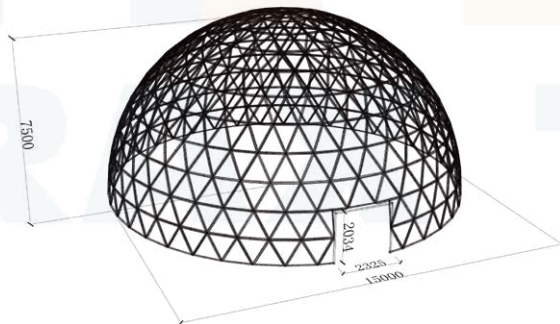
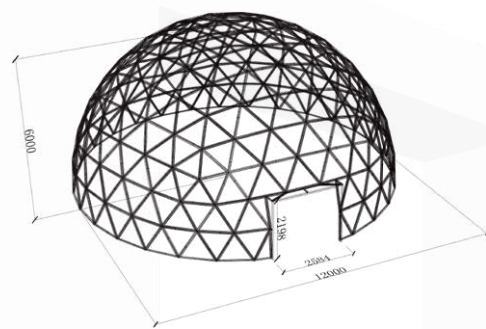
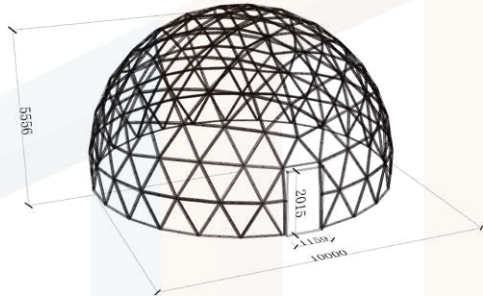
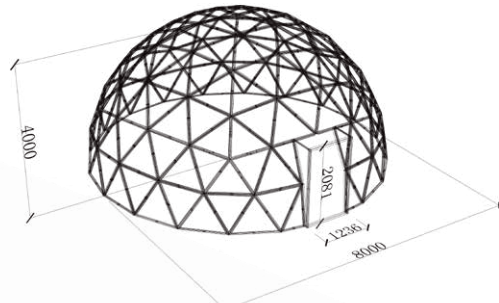
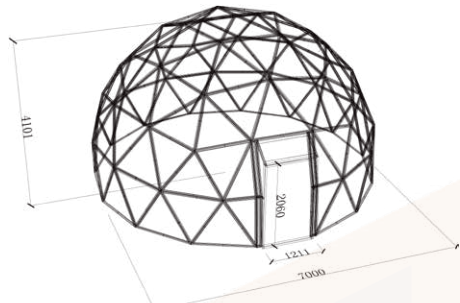
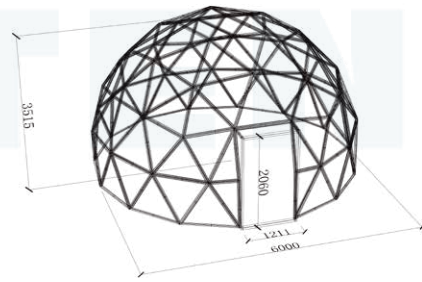
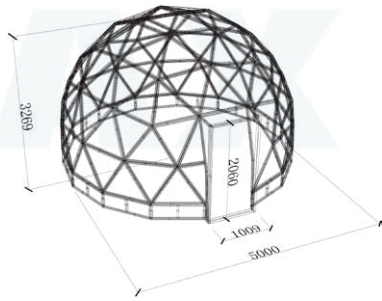
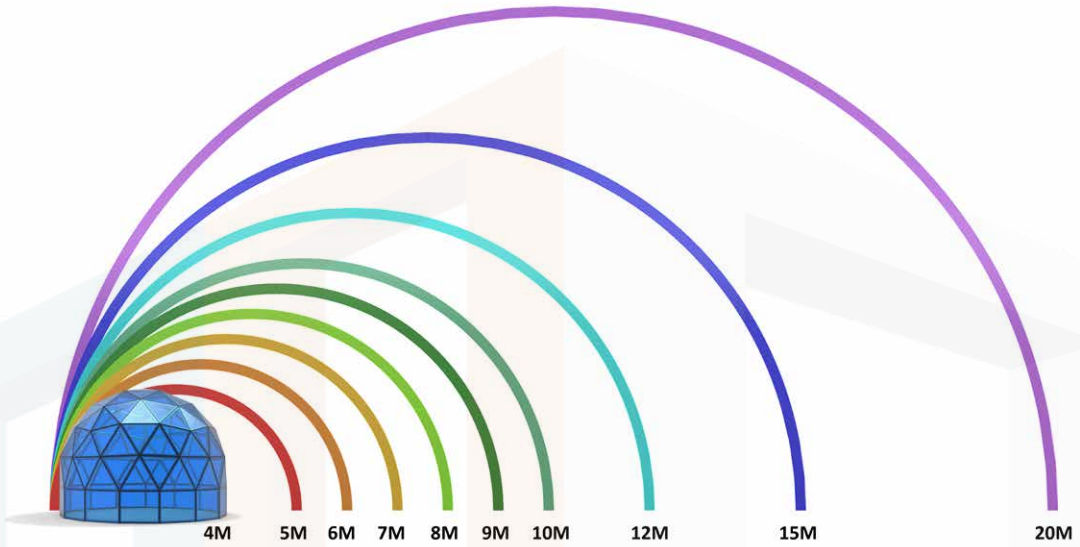



约旦经典案例 / *RAXTENT Glass Dome Project in Jordan*



RAXTENT

RAXTENT

RAXTENT

RAXTENT

RAXTENT

RAXTENT

RAXTENT

RAXTENT



约旦经典案例 / RAXTENT Glass Dome Project in Jordan





20米直径玻璃球 / *RAXTENT 20m Glass Dome Tent Project*

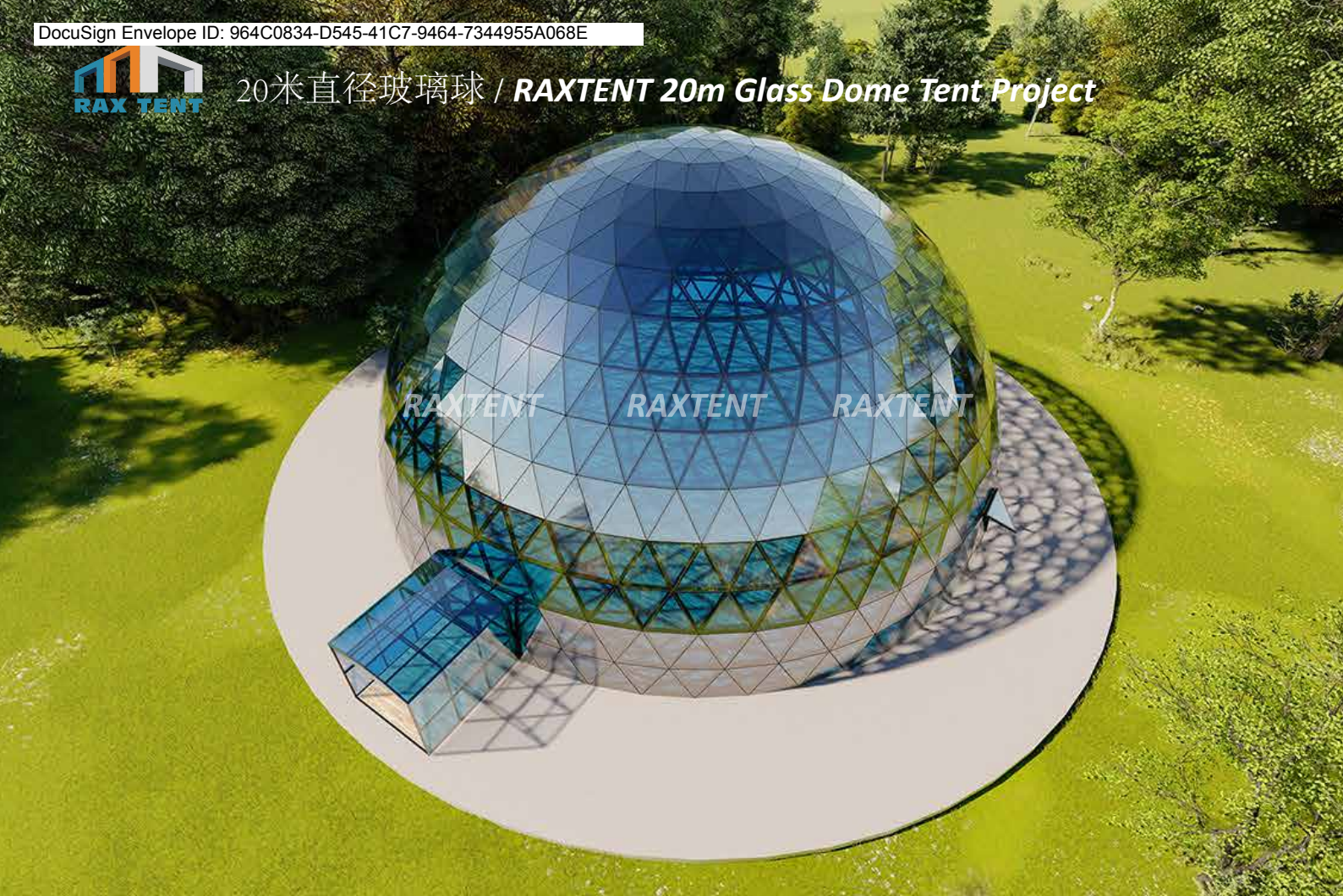

瑞立独家设计专利产品 / *RAXTENT Exclusive Design Patented Product*



20米直径玻璃球 / RAXTENT 20m Glass Dome Tent Project



瑞立独家设计专利产品 / RAXTENT Exclusive Design Patented Product



玻璃帐篷案例 / RAXTENT Glass Dome Tent Cases

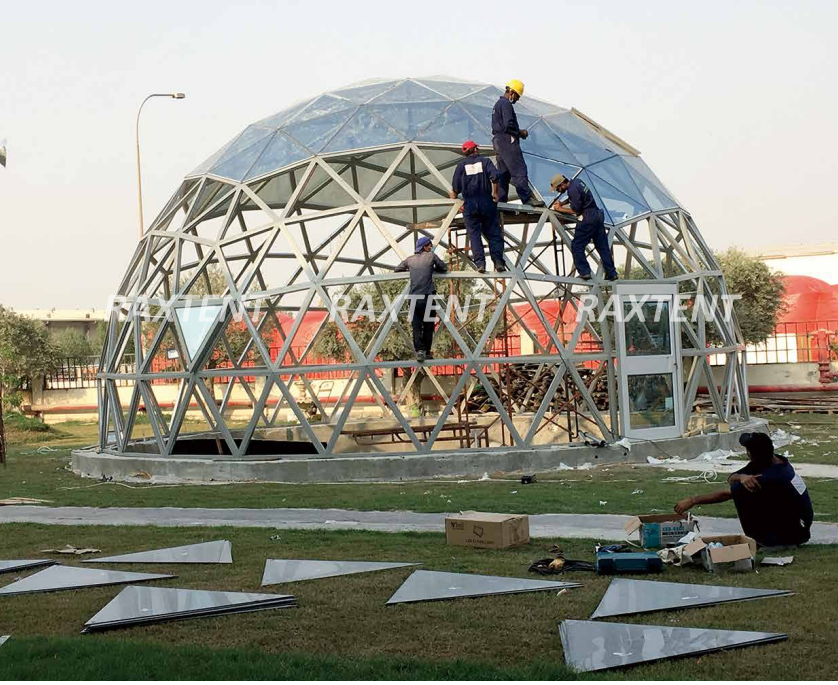



玻璃帐篷案例 / RAXTENT Glass Dome Tent Cases





PVC布球规格表 / *PVC DOME TENT Dimension Diagram*

PVC Dome Tent Size List

类目	尺寸/m	面积/m ²	顶高/m	容纳人数	抗风性	抗雪性
Raxtent Item No.	Dimension(m)	Area(Square Meter)	Ridge height(m)	Capacity	Wind load(km/h)	Snow Load(Kn/sqm)
RDT03	3m/10ft	7.06 sqm	2m	7 -10 people	100	0.3
RDT04	4m/13ft	12.56 sqm	2.5m	10-15 people	100	0.3
RDT05	5m/16ft	19.6 sqm	2.9m	20-25 people	100	0.3
RDT06	6m/20ft	28.2 sqm	3.5m	28-30 people	100	0.3
RDT08	8m/27ft	50 sqm	4.8m	50-60 people	100	0.3
RDT10	10m/33ft	78.5 sqm	5.8m	65-100 people	100	0.3
RDT15	15m/ 50ft	176.6 sqm	7.8m	135-300 people	100	0.3
RDT20	20m/67ft	314 sqm	10m	250-550 people	100	0.3
RDT25	25m/84ft	490.6 sqm	12m	500-950 people	100	0.3
RDT30	30m/100ft	706.5 sqm	15m	650-1200 people	100	0.3
RDT40	40m/134ft	1256 sqm	20m	1300-2500 people	100	0.3
RDT45	45m/ 150ft	1590 sqm	22m	1500-3000 people	100	0.3
RDT50	50m/167ft	1962.5 sqm	25m	1800-3500 people	100	0.3
RDT60	60m/200ft	2826 sqm	25m	3000-4000 people	100	0.3
RDT70	70m/234ft	3846.5 sqm	25m	4000-5000 people	100	0.3
RDT80	80m/266ft	5024 sqm	25m	5000-6000 people	100	0.3

RAXTENT PVC Dome Tent Material

Frame Material	Galvanized Steel coated white frame/Stainless steel pipe/Hop-Galvanized Pipe
Roof Fabric	850g/sqm block-out Double White PVC coated polyester
	Transparent PVC
	Transparent PVC + White PVC welding together
Fabric Material	PVC coated polyester
Fabric Features	Fire retardant, UV-retardant, 100% waterproof
Steel components	Hot-dip galvanized steel, the thickness over 60um
Accessories	Glass door / PVC windows / Skylight / Exclusive design of insulation
	Curtain / Electric blinds / Glass windows by hand / Electric glass window / Floor system / Bathroom / Stove / AC





PVC酒店帐篷 / PVC Hotel DOME TENT



三角形纱窗 / PVC window



纱窗 / PVC window



玻璃窗 / Glass window



双层保温层 / Exclusive insulation



单开玻璃门 / Single open Glass door



木纹玻璃门 / Wood style Glass door



窗帘 / Curtain



天幕 / Electric Blind



暖炉 / Heater / Fireplace



太阳能排气扇 / Solar energy fan



室内地板 / Wood floor



室外地板 / Platform Wood floor



PVC布球尺寸示意图 / PVC DOME TENT Dimension Diagram

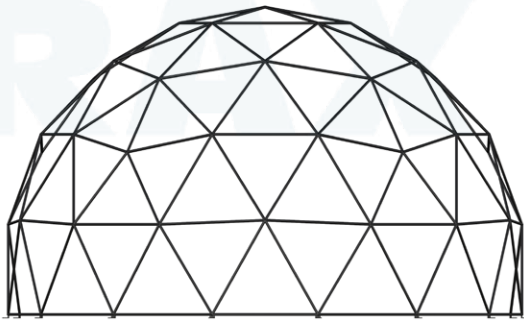
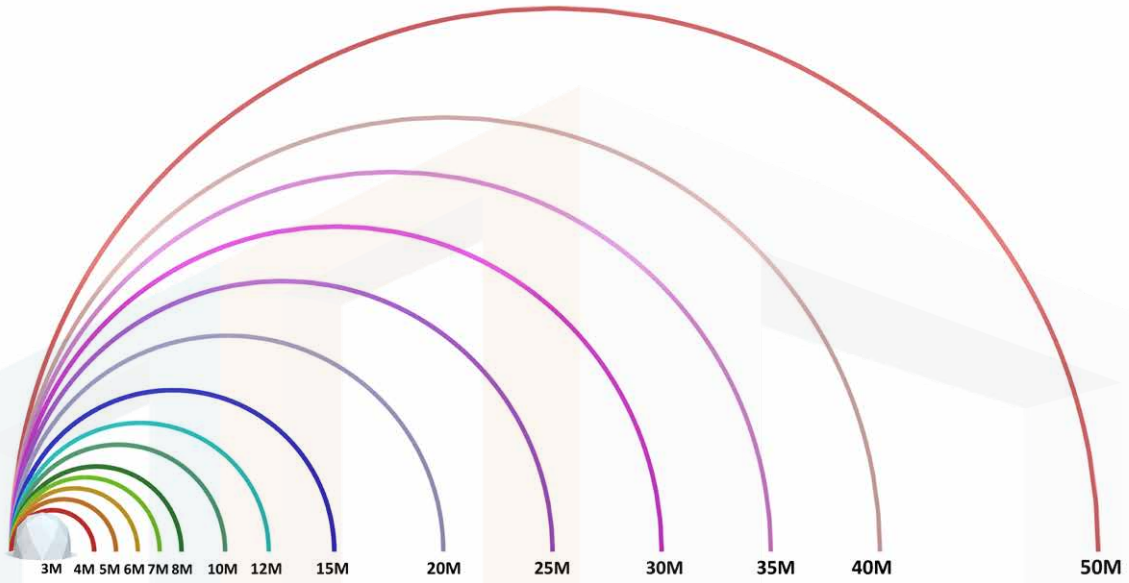

4-8m in Diameter

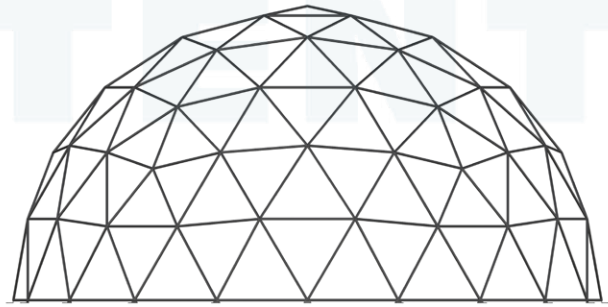

9-12m in Diameter

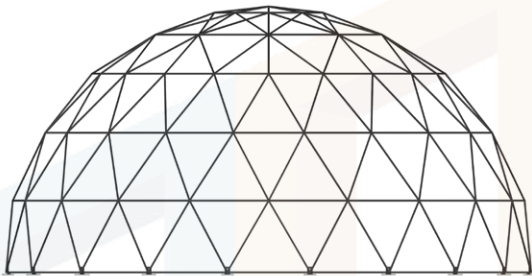

8-15m in Diameter

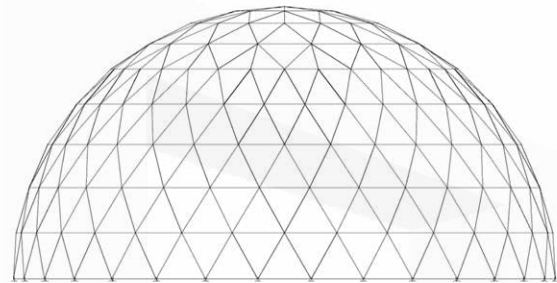

20-25m in Diameter

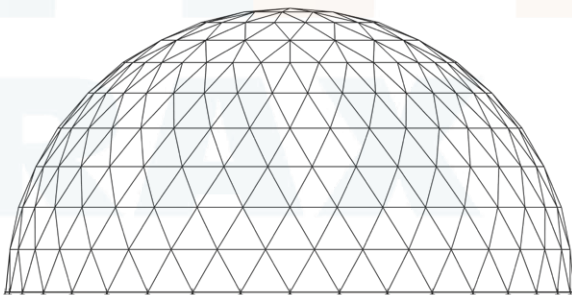

30-35m in Diameter

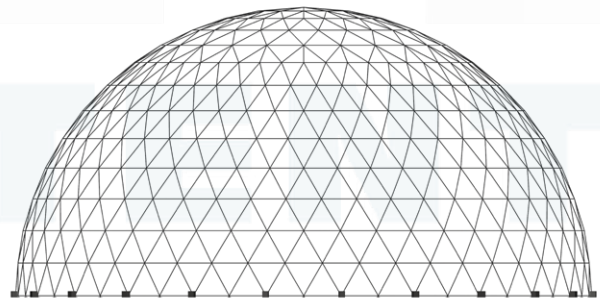

40-50m in Diameter



PVC 球形帐篷酒店系列 / RAXTENT PVC Hotel Dome Tent Cases





PVC酒店帐篷 / RAXTENT PVC Hotel Dome Tent





PVC 球形帐篷酒店系列 / RAXTENT PVC Hotel Dome Tent Cases





PVC 球形帐篷酒店系列 / RAXTENT PVC Hotel Dome Tent Cases





PVC 活动球形帐篷 / RAXTENT Big Event Dome Tent





PVC 活动球形帐篷 / RAXTENT Big Event Dome Tent

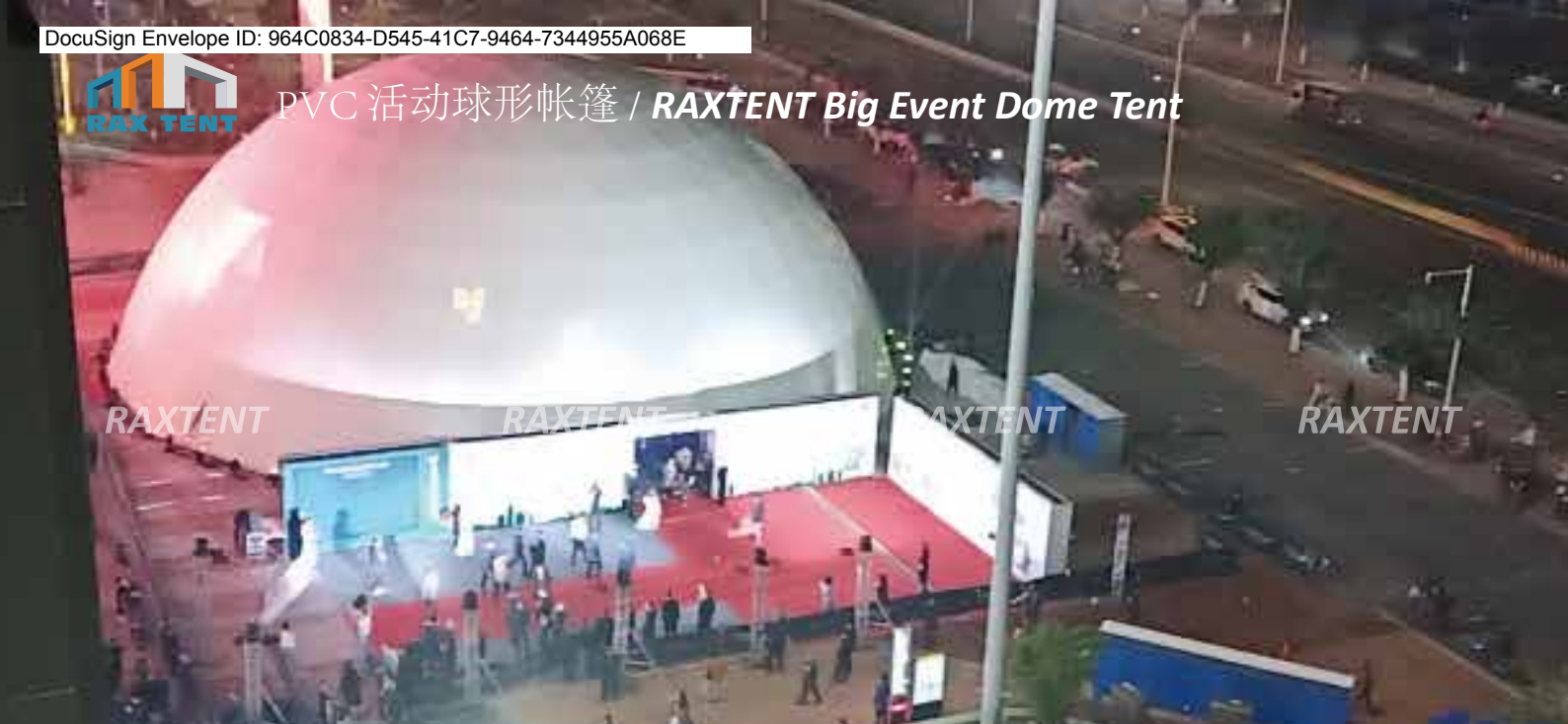



南瓜帐篷 / RAXTENT Pumpkin Tent



Pumpkin Tent Size List

类目	尺寸/m	面积/m ²	顶高/m	抗风性	抗雪性
Raxtent Item No.	Dimension(m)	Area(Square Meter)	Ridge height(m)	Wind load(km/h)	Snow Load(Kn/sqm)
RPT 6.5	6.5m / 21.7 ft	33 sqm	3.6 m	100	0.5

Tent Material

Frame Material	Galvanized Steel coated white frame, Q235
Coted color of structure	Standard frame coated white or black or gray, 3 kinds to choose
Top Tempered Glass	Laminated glass 5+0.75PVB +5mm
Glass Color	Blue / Green / Black / Grey / Clear, etc.
Accessories	Sliding glass door / Exclusive design of insulation / Curtain / Glass windows by hand / Floor system
Steel components	Hot-dip galvanized steel, the thickness over 60um



玻璃门 / Glass Door



玻璃窗 / Glass Window



玻璃天窗 / Skylight Glass



洗手间 / Bathroom





金字塔帐篷 / RAXTENT Glass Pyramid Tent

Pyramid Glass Tent Size List

类目	尺寸/m	面积/m ²	顶高/m	抗风性	抗雪性
Raxtent Item No.	Dimension(m)	Area(Square Meter)	Ridge height(m)	Wind load(km/h)	Snow Load(Kn/sqm)
RDT06	6m/20ft	36sqm	4.0m	100	0.3
RDT07	7m/23ft	49 sqm	5.9m	100	0.3

Material

Aluminum Structure	Patented industrial aluminum alloy profiles, 6061T6/T5
Coted color of structure	Standard frame coated white or black or gray, 3 kinds to choose
	Customized color: golden, etc
Tempered Glass	Single layer glass 5mm
	Hollow glass 5+9A+5mm
	Laminated glass 5+0.75PVB +5mm
	Triplex glass
Glass Color	Blue / Green / Black / Grey / Clear / Wood / White / Sliver , etc.
Accessories	Exclusive design of insulation / curtain / Glass windows by hand / Electric glass window / Floor system
Steel components	Hot-dip galvanized steel, the thickness over 60um



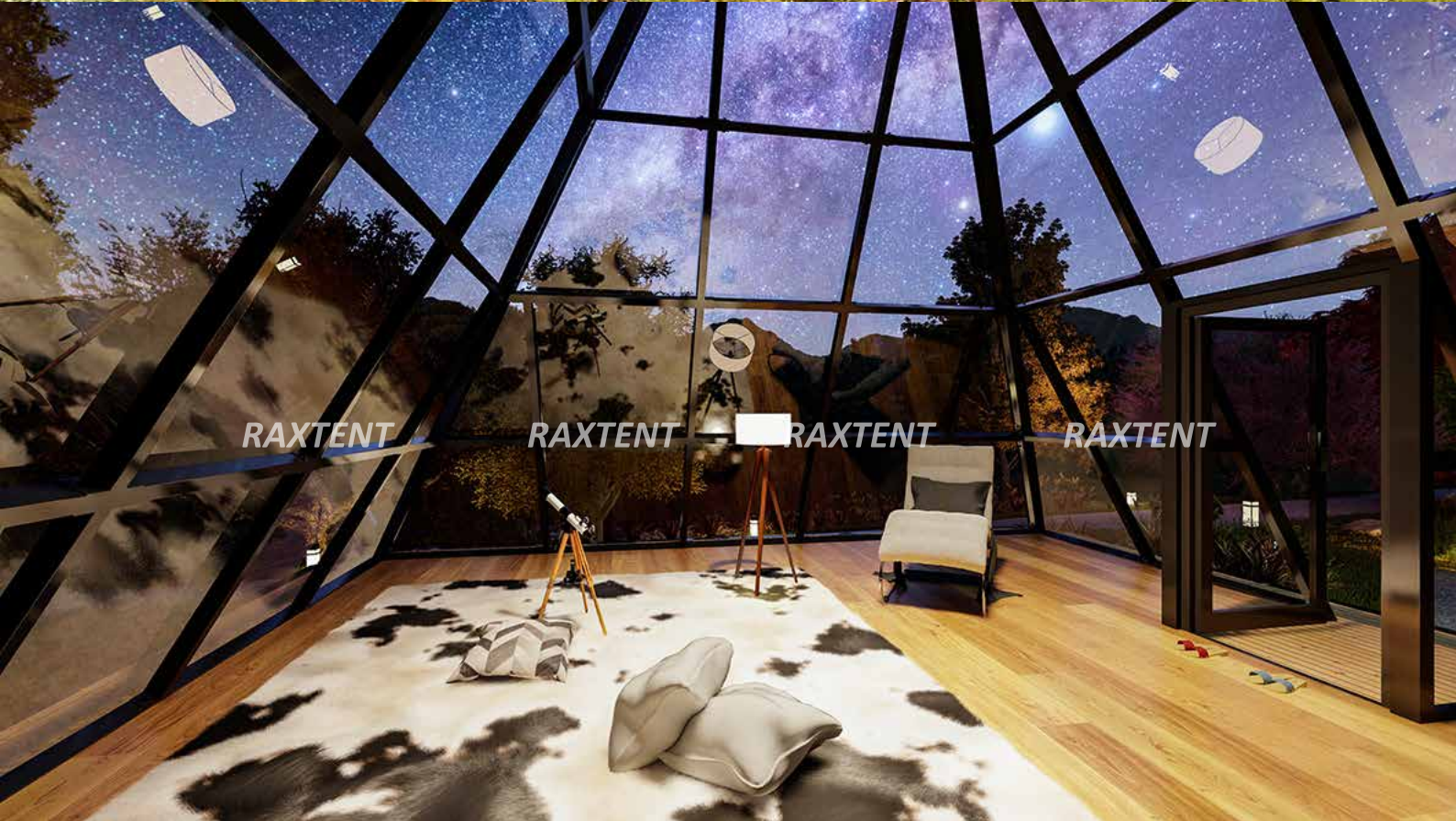



PVC 桃型帐篷 / RAXTENT PVC Zome Dome Tent



Zome PVC Tent Size List

类目	尺寸/m	面积/m ²	顶高/m	容纳人数	抗风性	抗雪性
Raxtent Item No.	Dimension(m)	Area(Square Meter)	Ridge height(m)	Capacity	Wind load(km/h)	Snow Load(Kn/sqm)
RDT03	3m/10ft	7.06 sqm	2m	7 -10 people	100	0.3
RDT04	4m/13ft	12.56 sqm	2.5m	10-15 people	100	0.3
RDT05	5m/16ft	19.6 sqm	2.9m	20-25 people	100	0.3
RDT06	6m/20ft	28.2 sqm	3.5m	28-30 people	100	0.3

Tent Material

Frame Material	Galvanized Steel coated white frame/Stainless steel pipe/Hop-Galvanized Pipe
Roof Fabric	850g/sqm block-out Double White PVC coated polyester
	Transparent PVC
	Transparent PVC + White PVC welding together
Fabric Material	PVC coated polyester
Fabric Features	Fire retardant, UV-retardant, 100% waterproof
Steel components	Hot-dip galvanized steel, the thickness over 60um
Accessories	Glass door / PVC windows / Exclusive design of insulation / Curtain / Floor system / Bathroom / Stove / AC

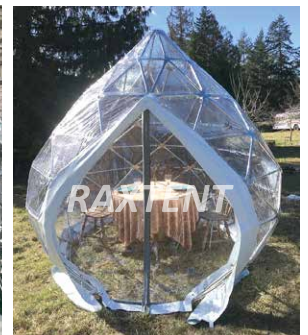



专利玻璃桃型帐篷 / RAXTENT Glass Zome Dome Tent

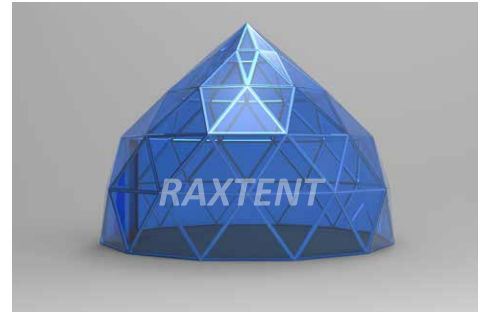
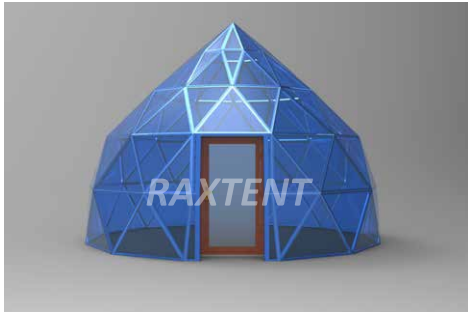

Zome Glass Tent Size List

尺寸/m	面积/m ²	顶高/m	框架	覆盖层	抗风性	抗雪性
Size / m	Sqm	Roof height/m	Structure	Roof cover	Wind load(km/h)	Snow Load(Kn/sqm)
6	28 sqm	4.5	Aluminum	Tempered glass	120km/h	0.5
7	39 sqm	5	Aluminum	Tempered glass	120km/h	0.5

RAXTENT Aluminum Glass Dome Tent Material

Aluminum Structure	Patented industrial aluminum alloy profiles, 6061T6/T5
Coted color of structure	Standard frame coated white or black or gray, 3 kinds to choose
	Customized color: golden, etc
Tempered Glass	Single layer glass 5mm
	Hollow glass 5+9A+5mm
	Laminated glass 5+0.75PVB +5mm
	Triplex glass
Glass Color	Blue / Green / Black / Grey / Clear / Wood / White / Silver , etc.
Accessories	Exclusive design of insulation / curtain / Glass windows by hand / Electric glass window / Floor system
Steel components	Hot-dip galvanized steel, the thickness over 60um



帽顶帐篷 / RAXTENT Peak Tent



Peak Tent Size List

Raxtent Item No.	SQM	Bay distance(m)	Side height(m)	Ridge height(m)	Main Frame profile(mm)	Wind load(km/h)	Snow Load(Kn/m ²)
RP30	30	2.4	2.5	5.6	100*80	100	0.3
RP60	60	2.4	2.5	5.6	100*80	100	0.3
RP90	90	2.4	2.5	5.6	100*80	100	0.3

Tent Material

Size	30sqm, 60sqm, 90sqm	
Frame Material	Galvanized steel coated white or black color	
Main frame Profile	100*80mm	
Roof Fabric	Top roof	850g/sqm block-out Double PVC coated polyester, Fire retardant, UV-retardant, waterproof.
	inside roof	850g/sqm block-out Double PVC coated polyester, Fire retardant, UV-retardant, waterproof.
Side wall	650g/sqm / 850g/sqm PVC / Glass wall / Sandwich wall	
Steel components	Hot-dip galvanized steel, the thickness over 60um	
Accessories	Sandwich wall, Glass wall, glass windows, curtain, roof lining - can choose	

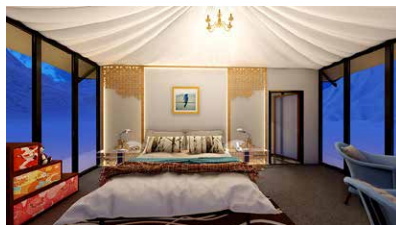



帽顶帐篷 / RAXTENT Peak Tent

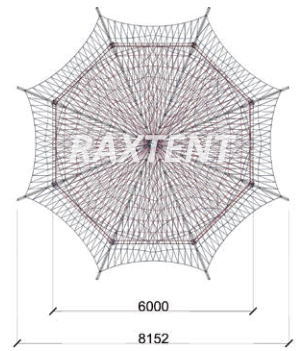
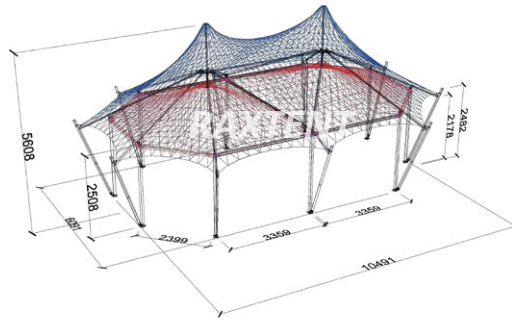
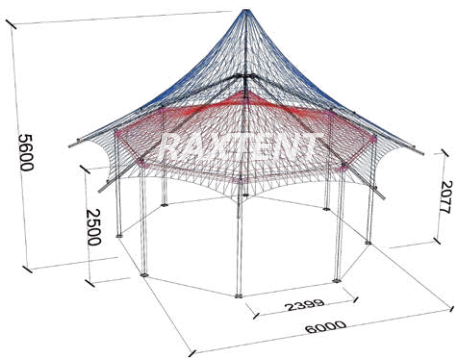



混合球 / RAXTENT MIX Glass Dome Tent



Mix PVC-glass Dome Tent Size List

类目	尺寸/m	面积/m ²	顶高/m	容纳人数	抗风性	抗雪性
Raxtent Item No.	Dimension(m)	Area(Square Meter)	Ridge height(m)	Capacity	Wind load(km/h)	Snow Load(Kn/sqm)
RDT05	5m/16ft	19.6 sqm	2.9m	20-25 people	100	0.3
RDT06	6m/20ft	28.2 sqm	3.5m	28-30 people	100	0.3
RDT07	7m/23ft	38.5 sqm	4.2m	30-40 people	100	0.3

Tent Material

Frame Material	Galvanized Steel coated white frame/Stainless steel pipe/Hop-Galvanized Pipe + square steel /aluminum structure
Roof cover	850g/sqm block-out Double White PVC coated polyester
	Tempered glass , Single layer glass 5mm / Hollow glass 5+9A+5mm / Laminated glass 5+0.75PVB +5mm
	Transparent PVC + White PVC welding together
Fabric Material	PVC coated polyester
Fabric Features	Fire retardant, UV-retardant, 100% waterproof
Steel components	Hot-dip galvanized steel, the thickness over 60um
Accessories	Glass door / PVC windows / Exclusive design of insulation / Curtain / Floor system / Bathroom / Stove / AC



混合球 / *RAXTENT MIX Glass Dome Tent*





贝壳帐篷 / RAXTENT Cocoon Tent



Cocoon Tent Size List

类目	尺寸/m	面积/m ²	顶高/m	容纳人数	抗风性	抗雪性
Raxtent Item No.	Dimension(m)	Area(Square Meter)	Ridge height(m)	Capacity	Wind load(km/h)	Snow Load(Kn/sqm)
5*8m	5*8m/133ft	40 sqm	3.5 m	30-40 people	100	0.3

Tent Material

Frame Material	Galvanized Steel coated white frame
Roof Fabric	850g/sqm block-out Double White PVC coated polyester
Fabric Material	PVC coated polyester
Fabric Features	Fire retardant, UV-retardant, 100% waterproof
Steel components	Hot-dip galvanized steel, the thickness over 60um
Accessories	Glass door / Exclusive design of insulation / Curtain / Floor system / Bathroom / AC





贝壳帐篷 / RAXTENT Cocoon Tent





Tree Tent Size List

类目	尺寸/m	面积/m ²	顶高/m	容纳人数	抗风性	抗雪性
Raxtent Item No.	Dimension(m)	Area(Square Meter)	Ridge height(m)	Capacity	Wind load(km/h)	Snow Load(Kn/sqm)
3m	3m /10 ft	9 sqm	3.0 m	2-3 people	100	0.3

Tent Material

Frame Material	Aluminum structure coated grey color
Roof Fabric	850g/sqm block-out Double White PVC coated polyester
Inside bed	Aluminum structure + 18mm thickness wood
Fabric Material	PVC coated polyester
Fabric Features	Fire retardant, UV-retardant, 100% waterproof
Steel components	Hot-dip galvanized steel, the thickness over 60um
Accessories	PVC windows



树屋 / *RAXTENT Tree Tent*

RAXTENT

RAXTENT

RAXTENT

RAXTENT



CONTACT US

Guangzhou Rax Tent Co.,Ltd

Tel: 0086-757-6336 5668

Mobile: +86-139 2910 9629 / +86-138 2211 5092

Email: raxtent@raxtent.com

ADD: No.3 on Fuyong Road, Fuyu Village, Leliu town, Shunde District, Foshan, Guangdong,China.

BUSINESS BROCHURE 2021

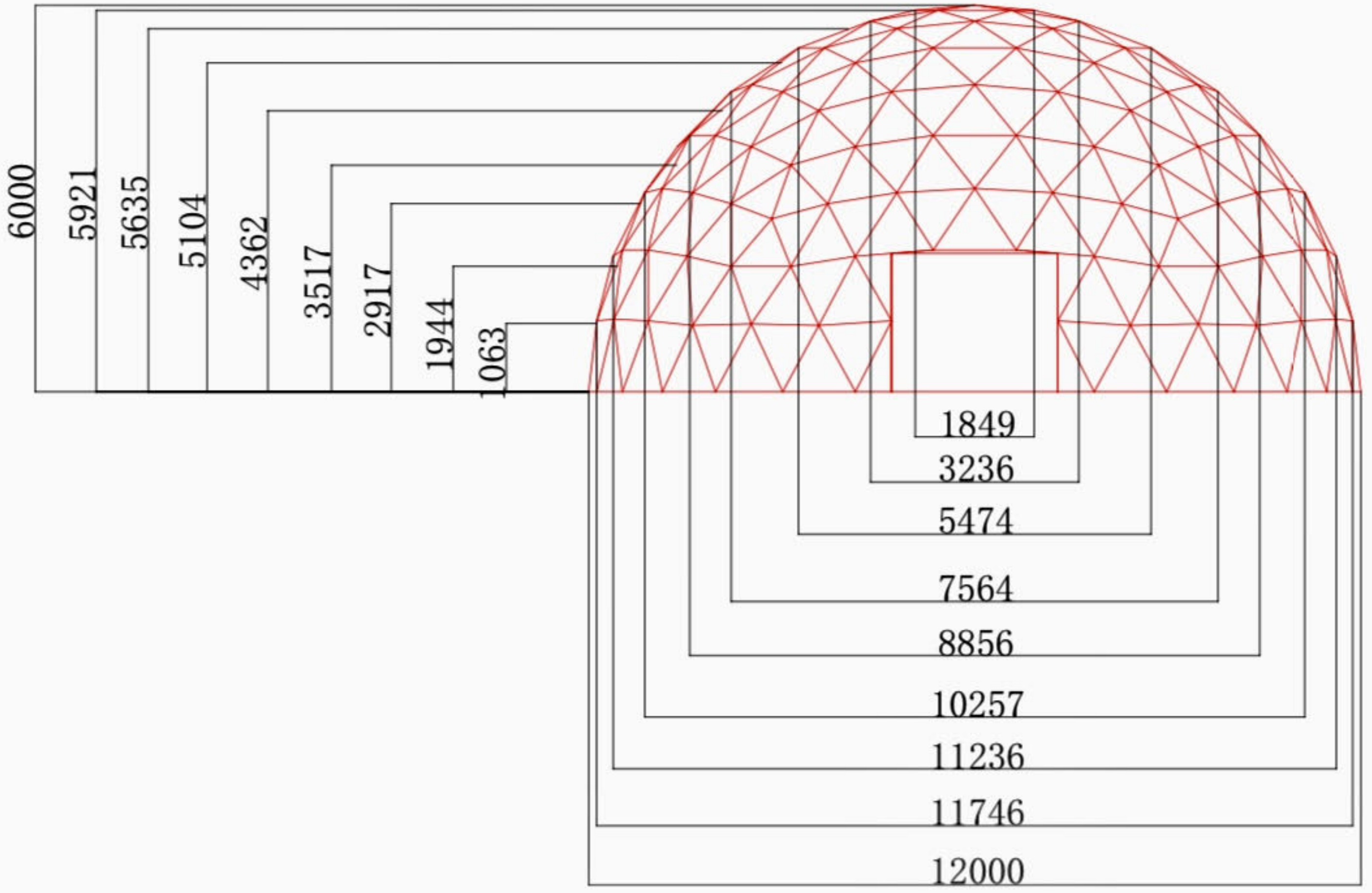

Issue Date	Issued For
5-27-08	DETROIT HISTORIC COMMISSION REVIEW
6-17-08	BOSTON EDISON NEIGHBORHOOD ASSN.
7-9-08	OWNER / CONTRACTOR REVIEW
9-12-08	BIDS & PERMITS

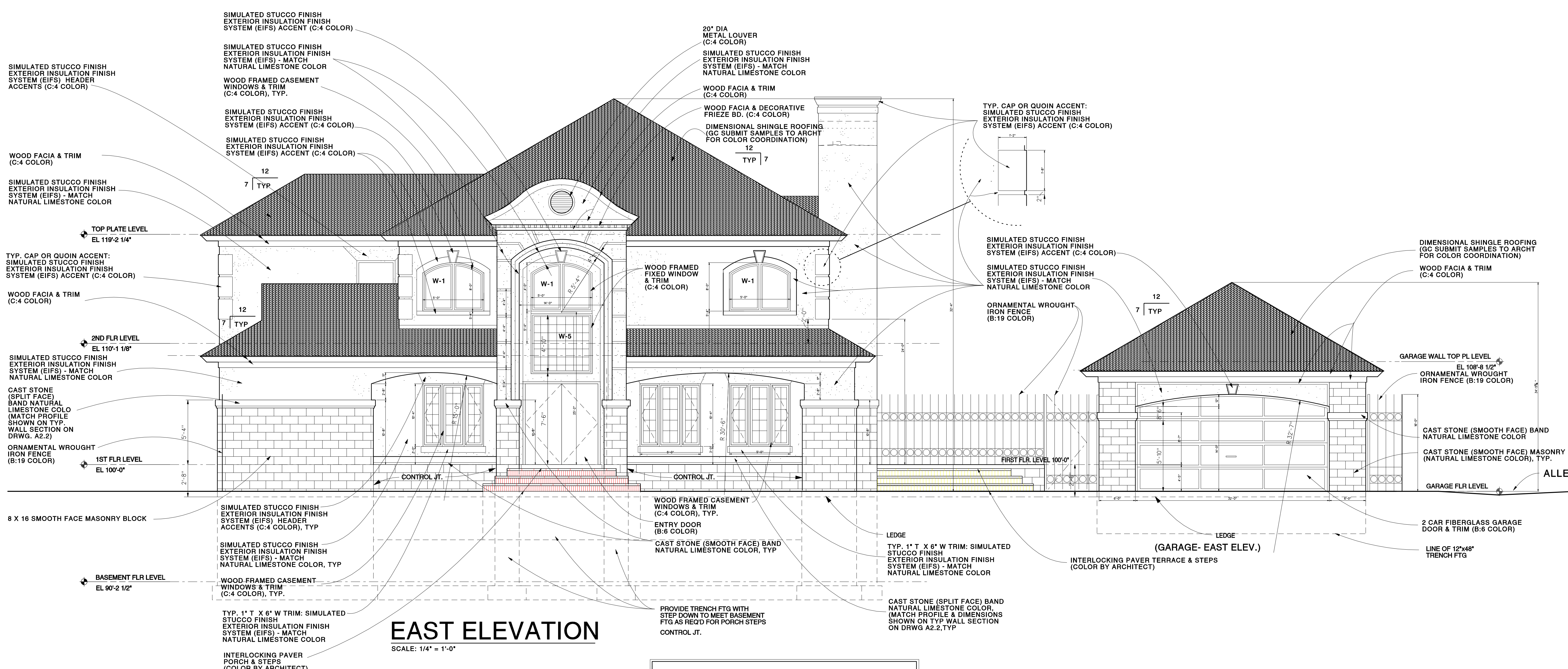

EAST ELEVATION

SCALE: 1/4" = 1'-0"

NOTE: MATERIALS & COLOR NOTES ON EAST ELEVATION ARE TYPICAL FOR SOUTH, EAST & WEST ELEVATIONS, UNLESS NOTED OTHERWISE

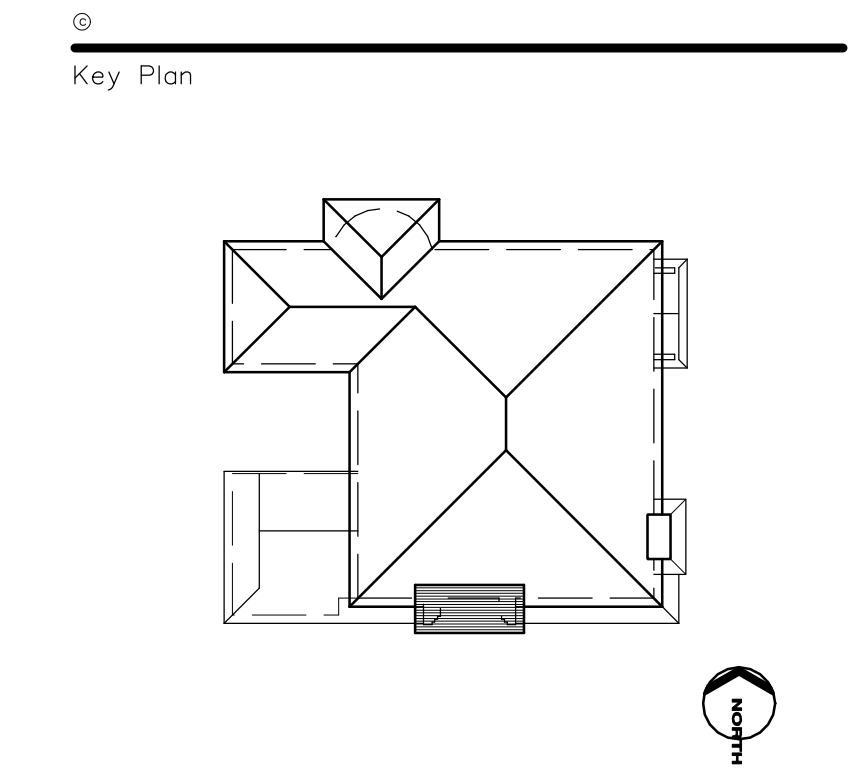

Project Administrator	Seal
D. PIGFORD	
Project Arch/Engineer	
D. PIGFORD	
Designed	
D. PIGFORD	
Drawn	
D. PIGFORD	
Checked	
D. PIGFORD	
Approved	Signature
D. PIGFORD	
Scale	Date
1/4" = 1'-0"	

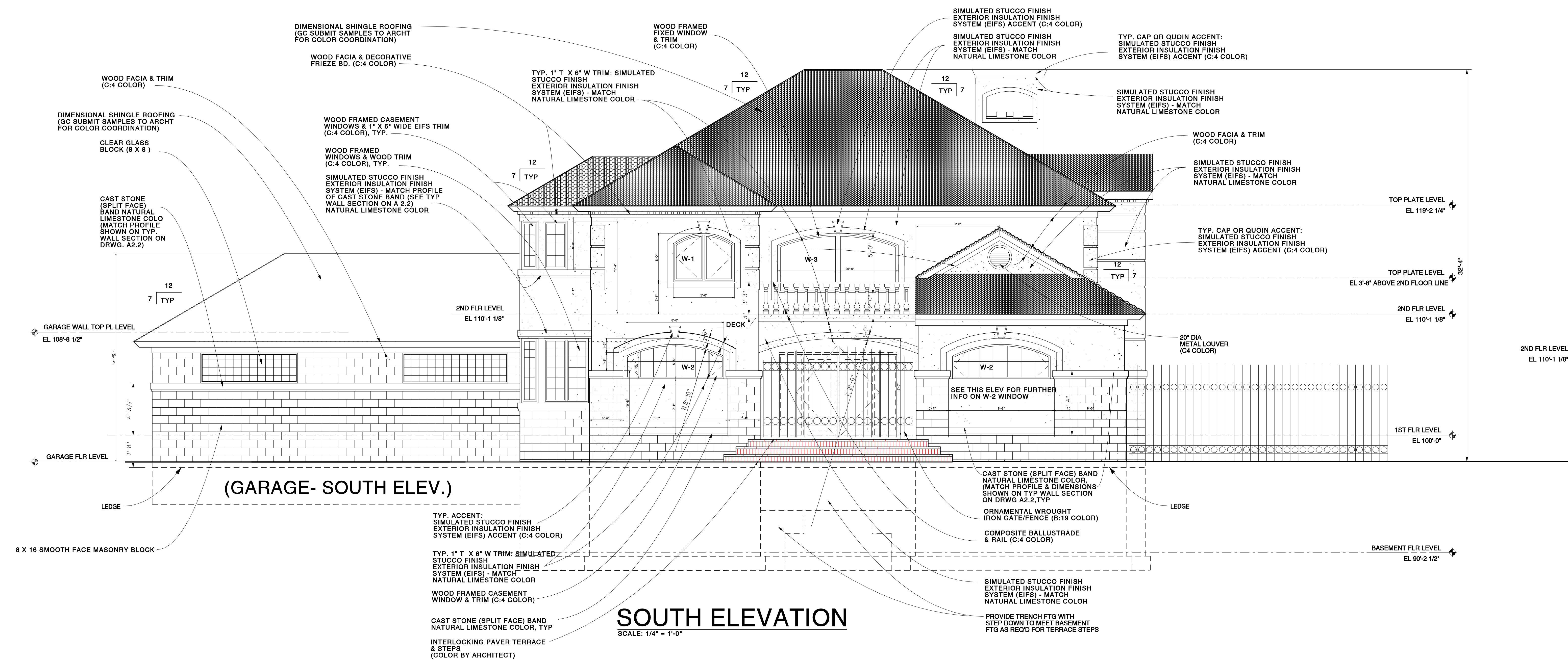

SOUTH ELEVATION

SCALE: 1/4" = 1'-0"

DPR Inc.
 DAVID A. PIGFORD REGISTERED ARCHITECT INC.
 "Quality Ideas and Documents"
 24175 NORTHWESTERN HWY., SUITE 140
 SOUTHFIELD, MICHIGAN 48075
 TEL. 248.356.7881 FAX. 248.233.0595

Project Title
ALEXANDER RESIDENCE
 1200 Longfellow
 Detroit, MI. 48202

Drawing Title
EXTERIOR ELEVATIONS (SOUTH & EAST)

Project No. Drawing No.
0402-08 A3.1

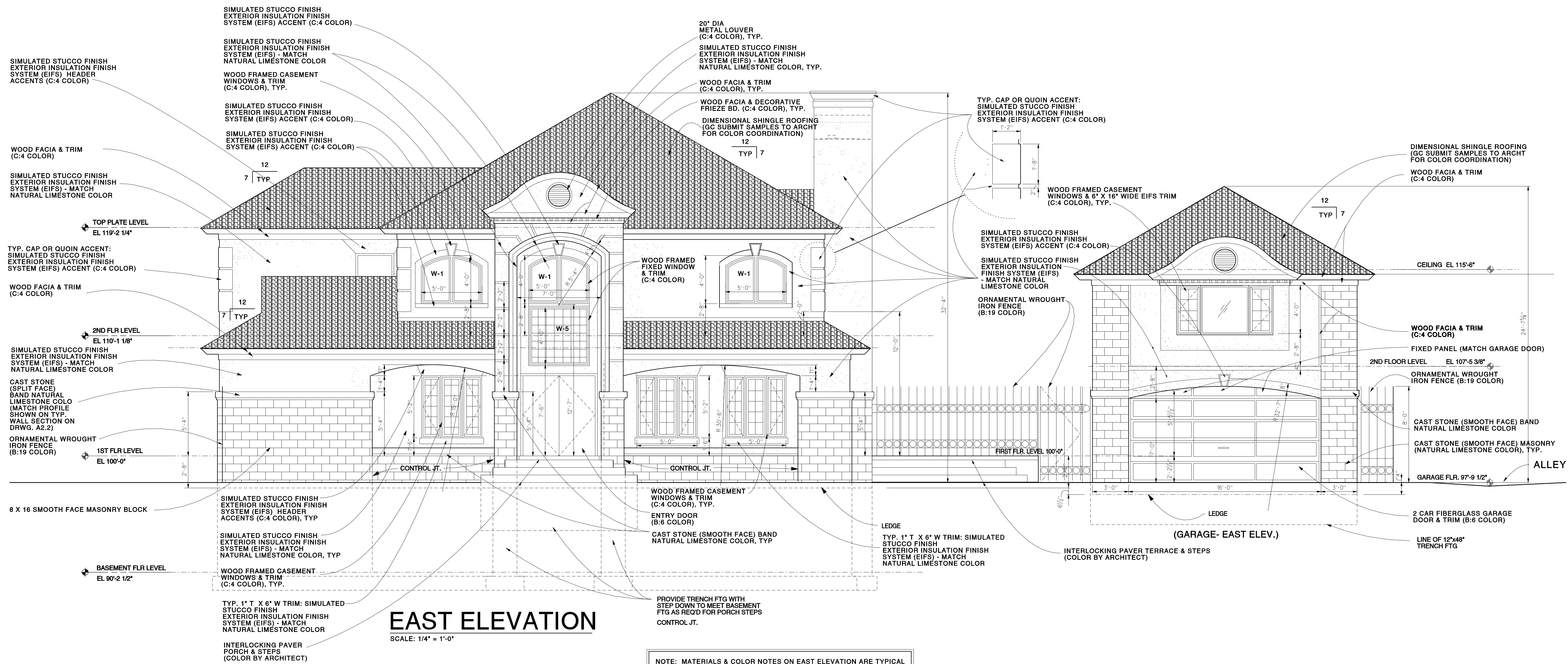

SHOWN WITH STUCCO FINISH

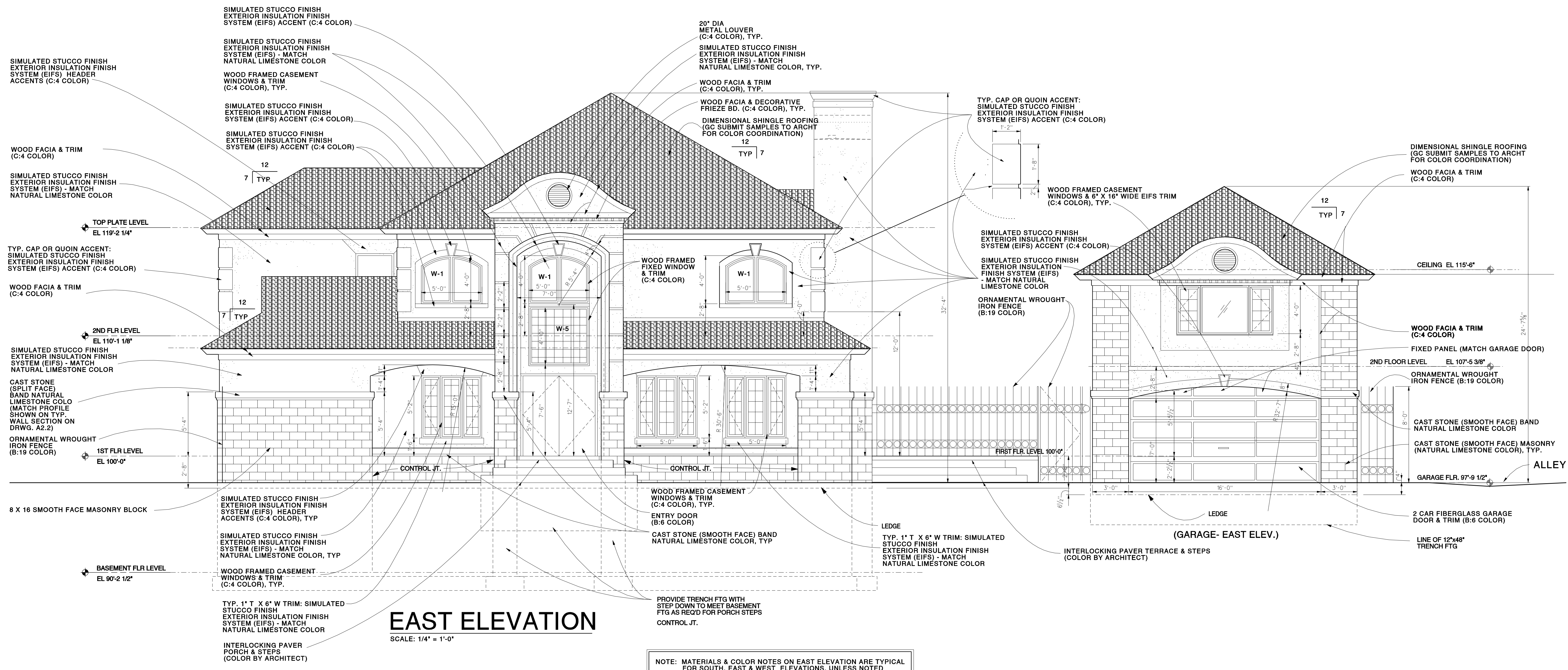

EAST ELEVATION

SCALE: 1/4" = 1'-0"

NOTE: MATERIALS & COLOR NOTES ON EAST ELEVATION ARE TYPICAL FOR SOUTH, EAST & WEST ELEVATIONS, UNLESS NOTED OTHERWISE.

SHOWN WITH STUCCO FINISH

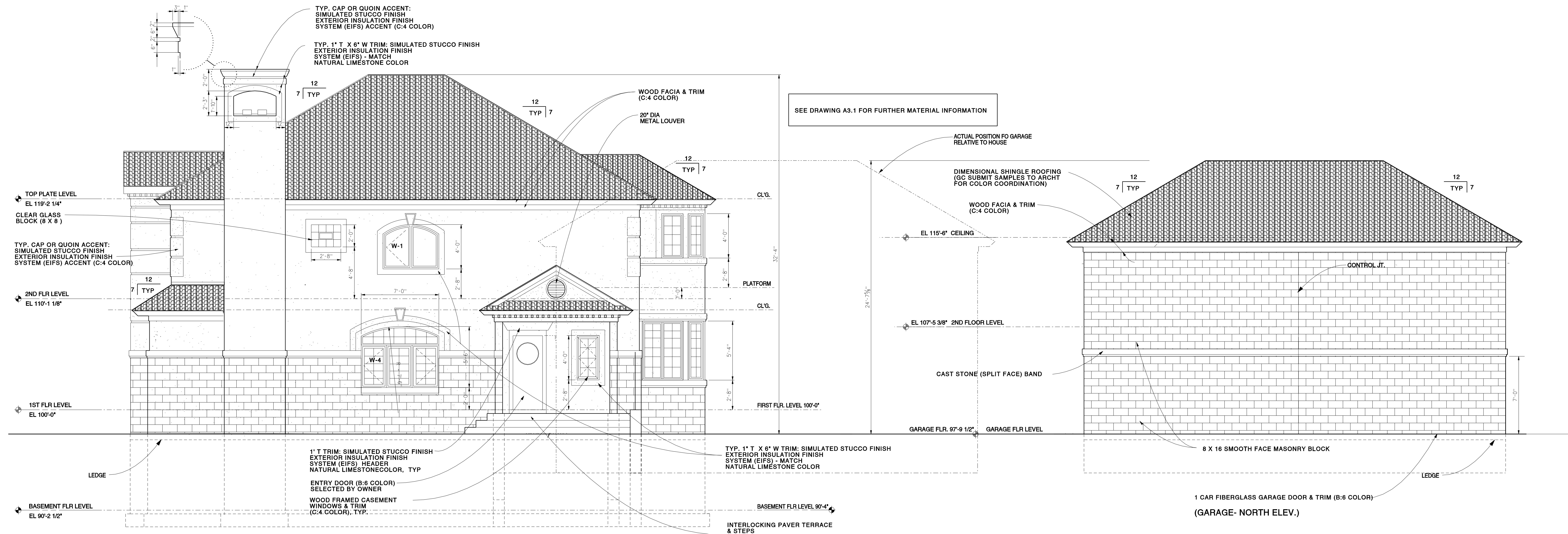

NORTH ELEVATION
SCALE: 1/4" = 1'-0"

