

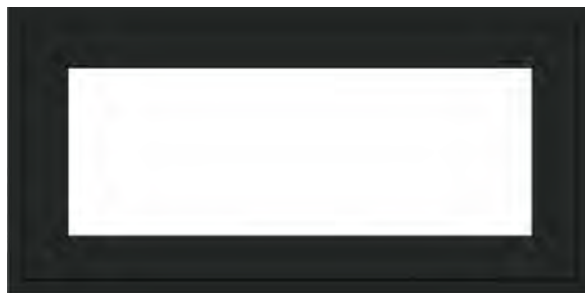

100 SERIES AWNING WINDOW



Interior



Exterior

Summary

Product ID#	100AS3016
Unit Width	35 1/2"
Unit Height	17 1/2"
Interior Color	White
Glass	Low-E Glass
Hardware	Folding Lock and Keeper, White
Grille Pattern	None
Exterior Color	Black





100 SERIES CASEMENT WINDOW



Interior

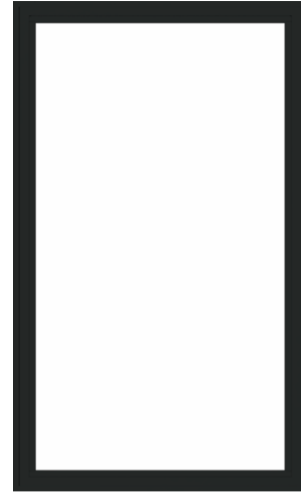

Exterior

Summary

Product ID#	100CS3050
Unit Width	35 1/2"
Unit Height	59 1/2"
Interior Color	White
Glass	Low-E Glass
Hardware	Folding Lock and Keeper, White
Grille Pattern	None
Exterior Color	Black





100 SERIES GLIDING PATIO DOOR



Interior



Exterior

Summary

Product ID#	100GD2P5068
Unit Width	59 1/4"
Unit Height	79 1/2"
Interior Color	White
Glass	Low-E4® Glass
Hardware	Tulsa, White
Grille Pattern	None
Exterior Door Color	Black



RED RECTANGLES DENOTE ARCHITECT'S SELECTIONS

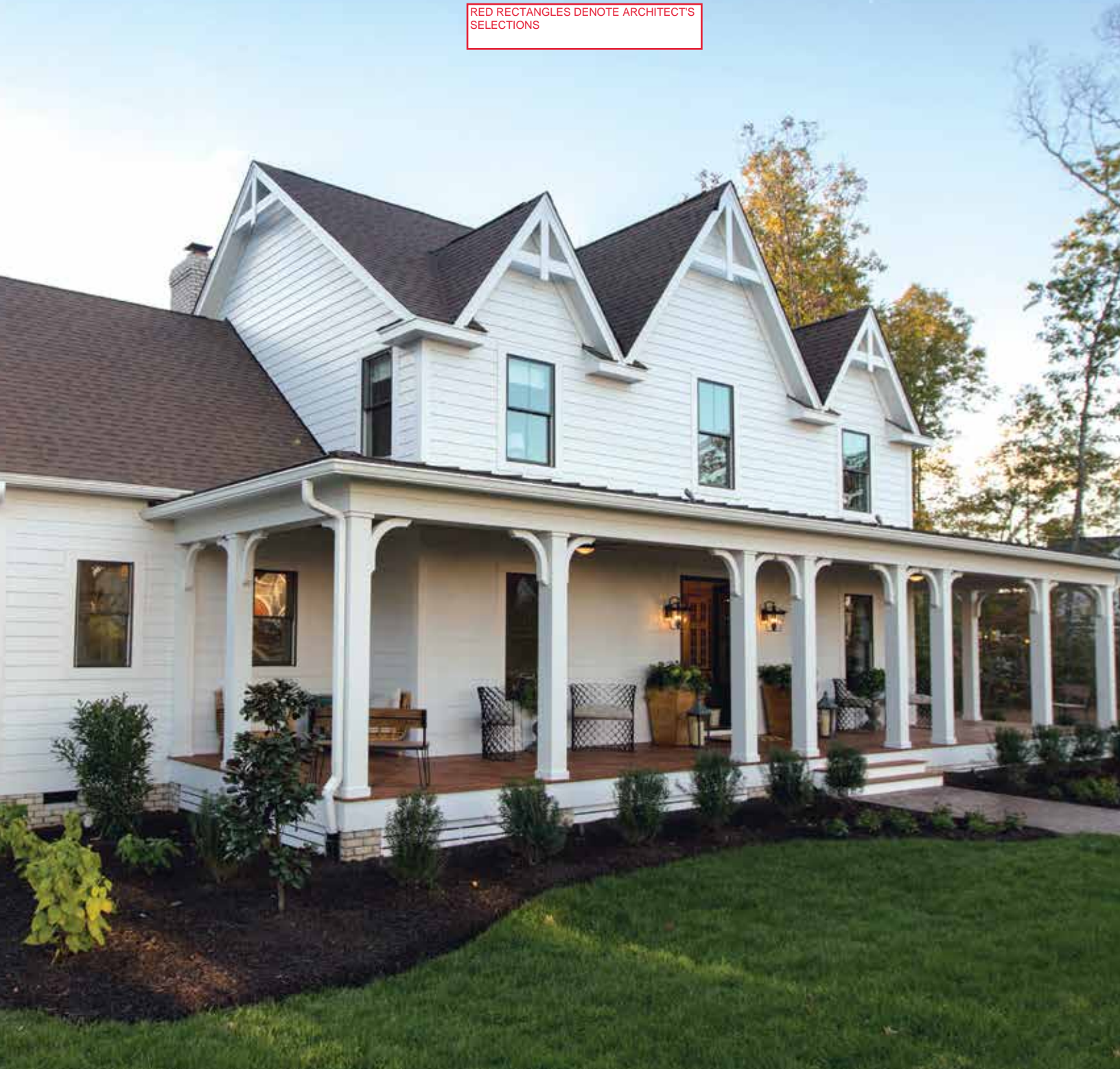

Discover a whole new
SIDE OF HOME.

Build confidently
BY DESIGN.





Installed on over 8 million homes* from coast to coast, James Hardie® fiber cement siding products are designed to resist the most extreme conditions while delivering long term beauty and lower maintenance. Enjoy the warm, natural look of wood with unprecedented peace of mind. It's easy to see what makes James Hardie the market leader.

UNIQUE FORMULATION

We use the highest quality raw materials and proprietary additives for enhanced strength and moisture protection.

FINISHING TECHNOLOGY

Baked-on color delivers a beautiful finish that resists fading and makes a lasting impression.

COMPLETE EXTERIOR

Offers homeowners an unrivaled collection of design options with exceptional warranties through a single, trusted manufacturer.

*Estimate based on total James Hardie siding sales through 2016 and average housing unit size.

CONTENTS

4	HardieZone® System
6	Unique Formulation
8	Finishing Technology
10	James Hardie Complete Exterior™
12	HardiePlank® Lap Siding
14	HardiePanel® Vertical Siding
16	HardieShingle® Siding
18	HardieTrim® Boards
20	HardieSoffit® Panels
22	Statement Collection™ Products
24	Color Inspiration
26	HardieWrap® Weather Barrier
27	Finishing Touches
28	The James Hardie Difference
30	Warranty and Endorsements

HardieZone® System

Only James Hardie® fiber cement products are Engineered for Climate®. In the northern U.S. and Canada, HZ5® products resist shrinking, swelling and cracking even after years of wet or freezing conditions. HZ10® products help protect homes from hot, humid conditions, blistering sun and more.

With James Hardie® siding and trim, homeowners have an exterior that's tougher than the elements and easy on the eyes.

NO MATTER WHAT NATURE BRINGS



HardieShingle®
Straight Edge
Timber Bark



HardieTrim®
Boards
Timber Bark

HardiePlank®
Lap Siding
Khaki Brown

TOUGHER THAN THE ELEMENTS



Stands up to storms
and harsh weather



Water resistant
to protect against
swelling, warping
and cracking



Won't be eaten by
animals or insects



Fire resistant



Helps reduce time
and money spent on
maintenance

Resist the elements
WITH IRRESISTIBLE BEAUTY.

Unique Formulation

HZ5[®] Substrate

Not all fiber cement is the same. The James Hardie HZ5 product formulation contains the highest quality raw materials. Proprietary additives, combined with an innovative manufacturing process and product design, create a substrate specifically engineered to reduce moisture and resist damage from wet or freezing conditions.

PROPRIETARY ENHANCEMENTS CREATE DURABLE JAMES HARDIE[®] SIDING



Perfect balance of strength and workability

Our balance of high-quality Portland cement, sand and cellulose fiber delivers the best combination of strength and workability.

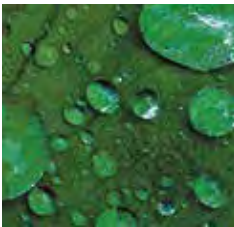

Enhanced moisture resistance for unmatched durability

Patented and proprietary additives are chemically bonded within the HZ5[®] substrate matrix to provide durable moisture resistance.



Increased dimensional stability

Our siding is engineered at the microscopic level to create a fiber cement composite with superior dimensional stability that helps protect against shrinking and splitting.



MADE IN THE
USA

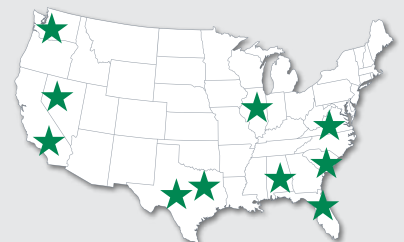

Integrity is ingrained
IN EVERYTHING WE DO.

HardiePlank®
Lap Siding
Evening Blue



The advanced design of HZ5® lap siding improves drainage from top to bottom.

In addition to the enhanced moisture resistance of our product formulation, HardiePlank® HZ5® lap siding features a modified profile with a sloped top and bullnose drip edge for improved drainage over the entire outer face of the board.



Sloped Top

Positive slope at top drains moisture to outer face of lap



Profiled Drip Edge

Bottom bullnose drip edge allows moisture to drain away from lap

Finishing Technology

Primer

A quality primer is the first step to ensuring that the paint color you select beautifully expresses a home's true character now – and for years to come. Our distinctive primer is climate-tested and engineered to enhance the performance of paint on James Hardie® fiber cement siding products. It helps to provide consistent, long-lasting paint adhesion, even in the most demanding conditions.

ColorPlus® Technology

Our advanced ColorPlus® Technology finishes deliver the ultimate in aesthetics and performance. Our products aren't simply painted at the factory. Our proprietary coatings are baked onto the board, creating a vibrant, consistent finish that performs better, lasts longer and looks brighter on your homes.

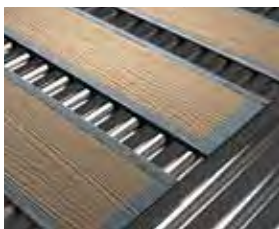

Exceptional finish adhesion

Our proprietary coating is engineered for exceptional adhesion to our substrate and applied to the surface, edges and features for durable performance.



Superior color retention

Finish is cured onto boards for a stronger bond, which allows for exceptional resistance to cracking, peeling and chipping.



Superior UV resistance

ColorPlus® Technology finishes retain vibrancy longer when compared to vinyl siding and typical field paints on other siding products.



ColorPlus®
Technology



HardieShingle®
Straight Edge
Cobble Stone

HardieTrim®
Boards
Arctic White

HardiePlank®
Lap Siding
Cobble Stone

Lasting beauty **BEGINS WITH THE FINISH.**

Our finishes help eliminate stress and reduce costly weather delays when it's too cold or damp to paint for extended periods. Now there's no reason to question whether or not sub-optimal painting conditions will negatively affect your paint job. In fact, there's no longer any need to paint on-site during installation.

ColorPlus® Technology finishes are fully cured in a controlled environment and arrive on your job site ready for year-round installation.





ColorPlus®
Technology
Pearl Gray

ColorPlus®
Technology
Iron Gray

For complete confidence wrap your
ENTIRE EXTERIOR WITH JAMES HARDIE.



James Hardie Complete Exterior™

Top to bottom, our exterior product line is defined by excellent performance, aesthetics and design options.

Provide protection from the elements, showcase a homeowner's individual style and install peace of mind with exceptional warranties through a single, trusted manufacturer.



HardieShingle®
Siding



HardiePanel® Vertical
Siding & HardieTrim®
Batten Boards

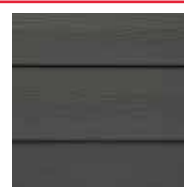

HardiePlank®
Lap Siding



HardieTrim®
Boards



HardieSoffit®
Panels

HardiePlank®

Sleek and strong, HardiePlank® lap siding is not just our best-selling product – it's the most popular brand of siding in America.

With a full spectrum of colors and textures, homeowners can enjoy protection from the elements and the versatility to make their dream home a reality. From Victorians to Colonials, HardiePlank lap siding sets the standard in exterior cladding.

HardieTrim®
Boards
Arctic White

HardiePlank®
Lap Siding
Select Cedarmill®
Khaki Brown

A classic look for
THE HOME OF THEIR DREAMS.

HardiePlank®

Thickness 5/16 in
Length 12 ft planks

SELECT CEDARMILL® & SMOOTH

	Width	5.25 in	6.25 in	7.25 in	8.25 in	9.25 in*
Exposure		4 in	5 in	6 in	7 in	8 in
Prime Pcs/Pallet		360	308	252	230	190
ColorPlus Pcs/Pallet		324	280	252	210	—
Pcs/Sq		25.0	20.0	16.7	14.3	12.5

SELECT CEDARMILL®



	Width	5.25 in	6.25 in	7.25 in	8.25 in	9.25 in*
STATEMENT COLLECTION™			✓		✓	
DREAM COLLECTION™		✓	✓	✓	✓	
PRIME		✓	✓	✓	✓	✓

SMOOTH



	Width	5.25 in	6.25 in	7.25 in	8.25 in	9.25 in*
STATEMENT COLLECTION™			✓		✓	
DREAM COLLECTION™		✓	✓	✓	✓	
PRIME		✓	✓	✓	✓	

BEADED CEDARMILL®



BEADED CEDARMILL® & BEADED SMOOTH

Width	8.25 in
Exposure	7 in
ColorPlus Pcs/Pallet	210
Pcs/Sq	14.3
STATEMENT COLLECTION™	—
DREAM COLLECTION™	✓
PRIME	—

BEADED SMOOTH

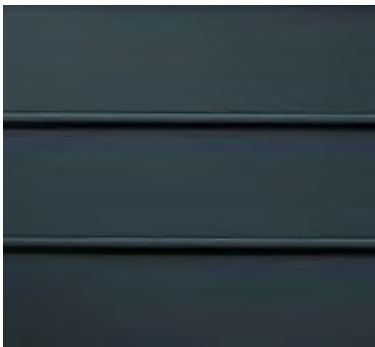

*9.25 in widths do not feature the drip edge

HardiePanel®

HardiePanel® vertical siding delivers style and substance. When combined with HardieTrim® boards, it achieves the rustic board-and-batten look that defines cottage charm. The covered seams contribute to a well-insulated home.

Its crisp, clean lines make HardiePanel vertical siding a smart choice for strong, contemporary designs.



HardiePanel®
Vertical Siding
Evening Blue

HardieTrim®
Batten Boards
Evening Blue

True to your needs of
PERFORMANCE AND BEAUTY.

HardiePanel®

Thickness 5/16 in

SELECT CEDARMILL®, SMOOTH, STUCCO & SIERRA 8

	Size 4 ft x 8 ft	4 ft x 10 ft
Prime Pcs/Pallet	50	50
ColorPlus Pcs/Pallet	50	50
Pcs/Sq	3.2	2.5

SELECT CEDARMILL®

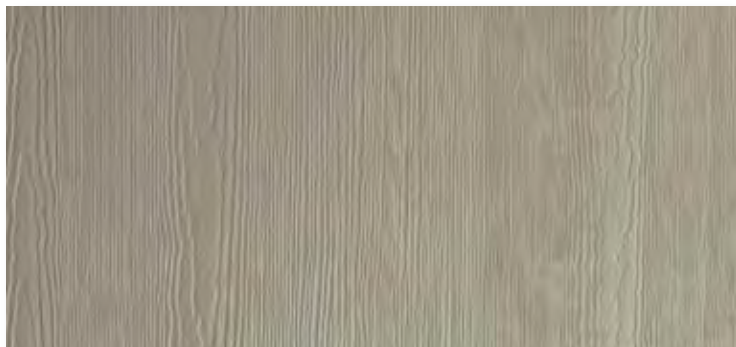

	Size 4 ft x 8 ft	4 ft x 10 ft
STATEMENT COLLECTION™		✓
DREAM COLLECTION™	✓	✓
PRIME	✓	✓

SMOOTH



	Size 4 ft x 8 ft	4 ft x 10 ft
STATEMENT COLLECTION™		✓
DREAM COLLECTION™	✓	✓
PRIME	✓	✓

STUCCO



	Size 4 ft x 8 ft	4 ft x 10 ft
STATEMENT COLLECTION™		
DREAM COLLECTION™	✓	✓
PRIME	✓	✓

SIERRA 8



	Size 4 ft x 8 ft	4 ft x 10 ft
STATEMENT COLLECTION™		
DREAM COLLECTION™		
PRIME	✓	✓

HardieShingle®

Restore the look of a grand Cape Cod or add distinction to a handsome bungalow. HardieShingle® siding embodies the enchanting look of cedar shingles with lower maintenance.

Better than the real thing, HardieShingle siding resists rotting, curling, warping and splitting.



HardieTrim®
Boards
Arctic White

HardieShingle®
Straight
Edge Panel
Pearl Gray

Achieve the handcrafted
LOOK OF CEDAR.

HardieShingle®

Thickness 1/4 in



STAGGERED EDGE PANEL

Length	48 in
Height	15.25 in
Exposure	6 in
ColorPlus Pcs/Pallet	100
Sq/Pallet	2
Pcs/Sq	50.0

STATEMENT COLLECTION™ _____

DREAM COLLECTION™ _____

PRIME _____



STRAIGHT EDGE PANEL

Length	48 in	48 in
Height	14 in	15.25 in
Exposure	5 in	7 in
ColorPlus Pcs/Pallet	120	86
Sq/Pallet	2	2
Pcs/Sq	60.0	43.0

STATEMENT COLLECTION™

DREAM COLLECTION™

PRIME _____



HALF ROUNDS

Length	48 in
Height	15.25 in
Exposure	7 in
Prime Pcs/Pallet	86
Sq/Pallet	2
Pcs/Sq	43.0

STATEMENT COLLECTION™ _____

DREAM COLLECTION™ _____

PRIME

HardieTrim®

Form meets function at every angle with HardieTrim® boards. With an authentic look, HardieTrim boards provide design flexibility for columns, friezes, doors, windows and other accent areas.

Better than wood, it will complement your long-lasting, lower maintenance James Hardie® siding – adding punctuation to your design statement.



HardieTrim®
Boards
Khaki Brown

HardiePlank®
Lap Siding
Navajo Beige

The performance you require.

THE DISTINCTIVENESS YOU DESIRE.

HardieTrim®

Length 12 ft boards

NT3® BOARDS SMOOTH

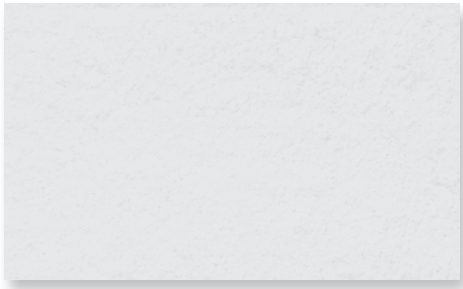

4/4 SMOOTH

Thickness	.75 in				
Width	3.5 in	5.5 in	7.25 in	9.25 in	11.25 in
ColorPlus Pcs/Pallet	312	208	156	104	104

STATEMENT COLLECTION™	✓	✓	✓		✓
DREAM COLLECTION™	✓	✓	✓	✓	✓
PRIME	_____				

5/4 SMOOTH

Thickness	1 in					
Width	3.5 in	4.5 in	5.5 in	7.25 in	9.25 in	11.25 in
ColorPlus Pcs/Pallet	240	200	160	120	80	80

STATEMENT COLLECTION™	✓	✓	✓	✓		✓
DREAM COLLECTION™	✓	✓	✓	✓	✓	✓
PRIME	_____					

BATTEN BOARDS

SMOOTH

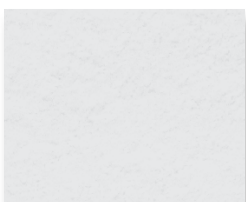

RUSTIC GRAIN®



SMOOTH & RUSTIC GRAIN®

Thickness	.75 in
Width	2.5 in
Prime Pcs/Pallet	190
ColorPlus Pcs/Pallet	437

STATEMENT COLLECTION™	✓
DREAM COLLECTION™	✓
PRIME	✓

HardieSoffit®

A home is only as strong as its weakest point. HardieSoffit® panels reinforce your work by protecting the vulnerable gap between eaves and exterior walls.

Available in vented, non-vented and a range of pre-cut sizes, these panels complete your design and help protect it from moisture and pests.

VENTILATION BENEFITS

Using vented soffit improves ventilation in the attic space and reduces the chance of water vapor condensation that can lead to issues such as mold and mildew growth, stained ceilings and damage to the framing of the house.

In warm climates, HardieSoffit panels allow hot, humid air to escape, which not only helps prevent condensation in the attic, but can also help reduce air conditioning costs.

In cool climates, HardieSoffit panels help prevent condensation from forming on the interior side of the roof sheathing and reduce the chances of roof-damaging ice dams.



HardieSoffit®
Panels
Dream Collection™
product

For complete confidence
EVERY DETAIL MATTERS.

HardieSoffit®

Thickness 1/4 in

VENTED SMOOTH & SELECT CEDARMILL®

Length	12 ft	12 ft	8 ft
Width	12 in	16 in	24 in
Prime Pcs/Pallet	200	150	100
ColorPlus Pcs/Pallet	216	156	108

VENTED SMOOTH

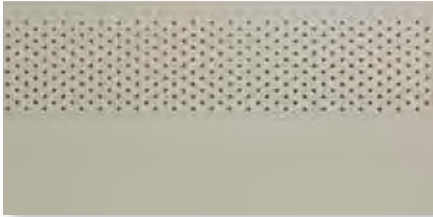

Size	12 ft x 12 in	12 ft x 16 in	8 ft x 24 in
------	---------------	---------------	--------------

STATEMENT COLLECTION™

DREAM COLLECTION™

PRIME

✓	✓	✓
✓	✓	✓

VENTED SELECT CEDARMILL®



Size	12 ft x 12 in	12 ft x 16 in	8 ft x 24 in
------	---------------	---------------	--------------

STATEMENT COLLECTION™

DREAM COLLECTION™

PRIME

✓	✓	✓

NON-VENTED SMOOTH & SELECT CEDARMILL®

Length	12 ft	12 ft	8 ft	8 ft
Width	12 in	16 in	24 in	48 in
Prime Pcs/Pallet	200	150	100	50
ColorPlus Pcs/Pallet	216	156	108	—

NON-VENTED SMOOTH

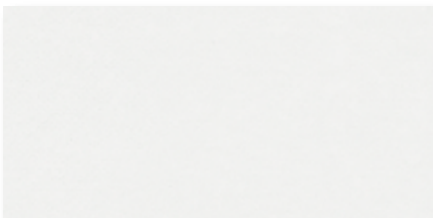

Size	12 ft x 12 in	12 ft x 16 in	8 ft x 24 in	8 ft x 48 in
------	---------------	---------------	--------------	--------------

STATEMENT COLLECTION™

DREAM COLLECTION™

PRIME

✓	✓	✓	
✓	✓	✓	✓

NON-VENTED SELECT CEDARMILL®



Size	12 ft x 12 in	12 ft x 16 in	8 ft x 24 in	8 ft x 48 in
------	---------------	---------------	--------------	--------------

STATEMENT COLLECTION™

DREAM COLLECTION™

PRIME

✓	✓	✓	

BEADED PORCH PANEL



Thickness	1/4 in
Length	8 ft
Width	48 in
ColorPlus Pcs/Pallet	50

BEADED PORCH PANEL

STATEMENT COLLECTION™

DREAM COLLECTION™

PRIME

—
✓
—

STATEMENT COLLECTION™

Make your next home stand out with our Statement Collection™ products. Carefully curated by our design experts specifically for your market, the collection brings together the most popular James Hardie ColorPlus® siding and trim styles, textures, and colors. This stunning selection is locally stocked and designed for simplicity - making it easier than ever to get a beautiful, long-lasting home exterior.

ColorPlus® Technology

Plank, Panel, Shingle and Batten Color Offering



ARCTIC WHITE

COBBLE STONE

NAVAJO BEIGE

KHAKI BROWN

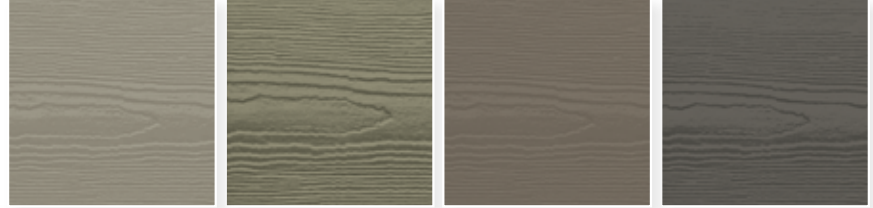

MONTEREY TAUPE

WOODSTOCK BROWN

TIMBER BARK

RICH ESPRESSO



HEATHERED MOSS

MOUNTAIN SAGE

LIGHT MIST

PEARL GRAY

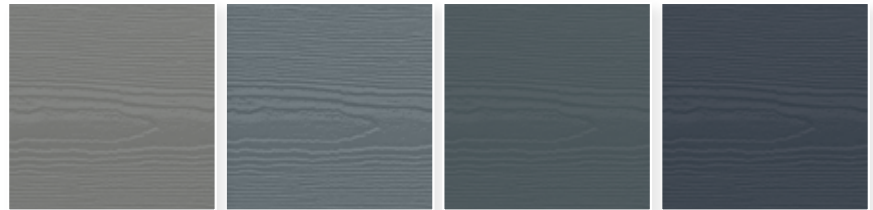

GRAY SLATE

BOOTHBAY BLUE

EVENING BLUE

DEEP OCEAN



AGED PEWTER

NIGHT GRAY

IRON GRAY

COUNTRYLANE RED

Trim Color Offering



ARCTIC
WHITE

COBBLE
STONE

KHAKI
BROWN

MONTEREY
TAUPE

TIMBER
BARK

IRON
GRAY

Colors shown are as accurate as printing methods will permit. Please see actual product sample for true color.

HardiePlank®



SELECT CEDARMILL®

Width 6.25 in 8.25 in
Exposure 5 in 7 in



SMOOTH

Width 6.25 in 8.25 in
Exposure 5 in 7 in

HardiePanel®



SELECT CEDARMILL®

Size 4 ft x 10 ft



SMOOTH

Size 4 ft x 10 ft

HardieShingle®



STRAIGHT EDGE PANEL

Height 14 in 15.25 in
Exposure 5 in 7 in

HardieTrim®

4/4 SMOOTH



Thickness .75 in
Length 12 ft boards
Width 3.5 in 5.5 in 7.25 in 11.25 in

5/4 SMOOTH

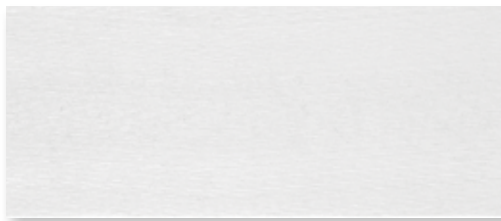

Thickness 1 in
Length 12 ft boards
Width 3.5 in 4.5 in 5.5 in 7.25 in 11.25 in

BATTEN BOARDS

4/4 SMOOTH & RUSTIC GRAIN®

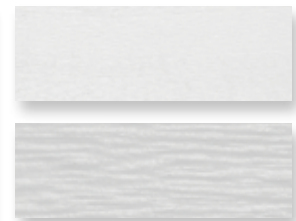

.75 in
2.5 in



Selecting a color? Request a product sample at jameshardiepros.com/samples

Get Inspired

CRISP & CLEAN

LIGHT COLORS

Whites and soft pastels are pure, clean, new and bright. Combine with other hues to add interest, personality and contrast. Works well on houses with Colonial Inspiration. A pastel A-frame cottage can look sweet and charming.



Arctic White

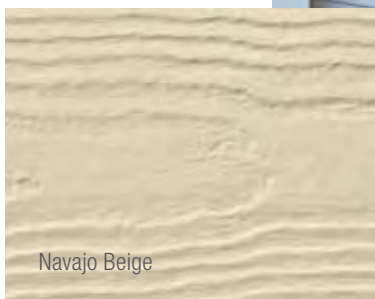

Navajo Beige

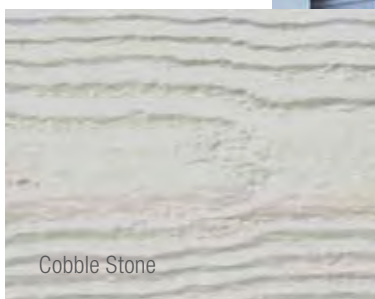

Cobble Stone



SUBTLE & SOPHISTICATED

NEUTRAL COLORS

Neutral rules the suburbs. These shades are safe, but also sophisticated. When accessorized with black or a darker color, a neutral can look fashionably stylish. Play with textures and use different tones for trim.

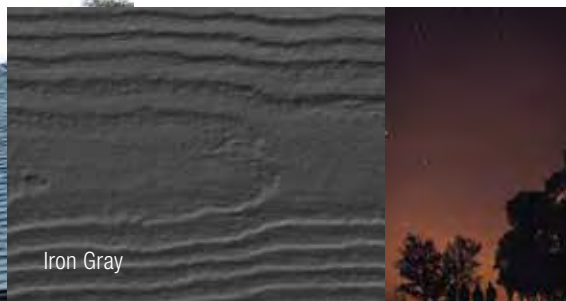
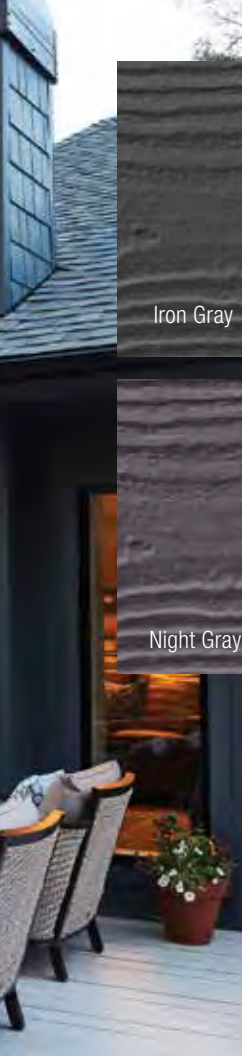

Iron Gray

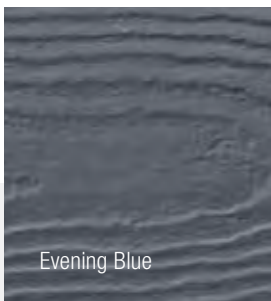

Evening Blue



Night Gray



A BOLD CHOICE

DARK COLORS

Dark grays, blues and greens can feel both intellectual and modern. When used with white trim, they create drama. Works well in old neighborhoods, or urban environments, where there is a mix of old and new.

DREAM COLLECTION™

Looking to further express your sense of style? Look to our Dream Collection™ products.

- Featuring a color palette of over 700 ColorPlus® Technology finishes
- Made to order in a wide array of James Hardie® siding and trim styles
- Matches elevated design flexibility with the uncompromising performance of our fiber cement products

To see what's possible and order Dream Collection product samples visit jameshardiepros.com/dream



Khaki Brown



Monterey Taupe



Timber Bark



HardieWrap®

No exterior cladding can prevent 100% of water intrusion. Your homes should have an additional line of defense. HardieWrap® weather barrier provides a superior balance of water resistance and breathability, keeping the area within the wall drier. This helps prevent moisture accumulation that may lead to mold and mildew growth.

INSTALLATION ADVANTAGES

- Thicker, more durable material for easier, quicker installation
- Superior tear resistance helps prevent water infiltration
- Can be installed with staples in place of cap nails for cost savings
- Provides a higher level of performance, no matter what type of cladding you specify



We've got performance covered
FROM THE INSIDE OUT.



HardieWrap®
Weather Barrier

HardieWrap®
Pro-Flashing

HardieWrap®
Flex Flashing

HardieWrap®
Seam Tape

WEATHER BARRIER

Thickness	11 mil			
Length	100 ft	100 ft	150 ft	150 ft
Width	3 ft	9 ft	9 ft	10 ft

PRO-FLASHING

Thickness	20 mil		
Length	75 ft	75 ft	75 ft
Width	4 in	6 in	9 in

FLEX FLASHING

Thickness	60 mil	
Length	75 ft	75 ft
Width	6 in	9 in

SEAM TAPE

Thickness	3.2 mil
Length	164 ft
Width	1-7/8 in



To learn more about our weather barrier's advantages, visit jameshardiepros.com

Install Done Right

Installation Accessories

HARDIEBLADE® SAW BLADES

Manufactured by Diablo, the HardieBlade® saw blade is designed specifically to cut fiber cement products, and is the only saw blade James Hardie recommends. The blade creates clean, precise cuts while helping to reduce the amount of airborne dust produced. Specially designed to outlast other fiber cement saw blades by 3X, outlasting carbide blades by 60X.



PACTOOL® GECKO GAUGE

The PacTool® Gecko Gauge is designed to improve the installation experience, allowing one person to hang HardiePlank® lap siding during installation. Studies suggest the Gecko Gauge can improve the speed of solo installation by 30%.



Finishing Touches

ColorPlus® Technology Accessories

TOUCH-UP KITS

Specially formulated to match ColorPlus Technology finishes, our touch-up kits offer resistance to aging, color change and chalking. Estimated one kit per 4000 sq ft of siding or 1600 sq ft of trim.



COLOR MATCHED CAULK

OSI® QUAD® MAX sealant offers a high performance sealant solution to color match Statement Collection™ products.* About 18-20 linear feet per tube. Refer to packaging for manufacturer's recommendations.

**For matching Dream Collection products, contact your local James Hardie representative.*

Trim Accessories

FLAT TABS

Eliminate face nails and improve the aesthetic of trim applications around windows, doors and band boards.

CORNER TABS

Use corner tabs to eliminate face nail holes that would detract from the finished look of corner trim installations.



Find useful job-site tips in our industry-leading Best Practices Guide. For the latest installation instructions, visit jameshardiepros.com



HardiePlank®
Select Cedarmill®
Timber Bark

HardieTrim®
Boards
Arctic White

As unforgettable
AS IT IS UNCOMPROMISING.



See the James Hardie Difference



James Hardie invented fiber cement. Over 8 million homes* later, we continue to set the standard in premium, high-performance exterior cladding. Our products deliver uncompromising durability and finish quality for a beautiful, lower maintenance exterior.

Our unrivaled investment in R&D and constant innovations in product design, manufacturing and distribution allow us to remain steps ahead of the competition. With the support of our employees, partners and exceptional warranties, we're committed to protecting your customers' homes while helping your business grow.

*Estimate based on total James Hardie siding sales through 2016 and average housing unit size.

Warranty – for peace of mind

Protect your homes with North America's #1 brand of siding backed by exceptional warranties. Unlike other brands, James Hardie doesn't prorate our siding and trim warranty coverage. We stand behind our siding 100% for 30 years and trim for 15 years.

ColorPlus® Technology finishes come with a 15-year limited warranty.

James Hardie Non-Prorated Siding Substrate Warranty Coverage



Endorsements – a reputation built on trust

For decades, our fiber cement products have been used to create better places to live. Each new home stands as a testament to our uncompromising quality. That proven track record has earned the loyalty of millions of homeowners and the endorsements of trusted authorities across the building industry.



Listed as top building materials & products by **Professional Builder 2018**



Chosen by builders as a **Brand Leader** in **Builder magazine** for over 20 years



James Hardie® siding & trim products have earned the **Good Housekeeping Seal**



HardieTrim®
Boards
Arctic White

HardieShingle®
Straight Edge
Pearl Gray

Make every home
STAND UP AND STAND OUT.



HardiePanel®
Vertical Siding
Iron Gray

HardieTrim®
Batten Boards
Iron Gray

1.888.542.7343 | jameshardiepros.com

© 2020 James Hardie Building Products Inc. All Rights Reserved. TM, SM, and ® denote trademarks or registered trademarks of James Hardie Technology Limited. OSI and QUAD are trademarks of Henkel Corporation. HS2013 02/20

 **JamesHardie™**
Siding | Trim

WOODTONE

INTERIOR & EXTERIOR PRODUCT CATALOGUE

RED RECTANGLES DENOTE
ARCHITECT'S SELECTIONS



WOODTONE
inspired living, *inside and out*



02	Introduction
03	RealTrim™ Treated
05	RusticSeries™ Siding
09	Chrometallics™ Siding
11	ColorSelect™ Siding
13	Wall + Ceiling Collection
17	Shiplap Paneling
19	RealPost™
20	RealCorner™
21	AbsolutePost™
22	AbsoluteTrim™
23	The Woodtone Way

At Woodtone, we strive to take your vision and bring it to life. We design, manufacture and market the finest interior and exterior building products.

RealTrim™ Treated



Superior grade, treated trim product.

For four decades you've depended on us for a superior trim product. Over the years we've continued to innovate, providing the cutting edge product you need to stay on top. The two-step treated sealant process used in creating RealTrim™ Treated has been engineered by Sherwin Williams, the largest coating expert in North America.

- Industry leading 25 year limited warranty
- Tight grain, hand selected SPF wood trim
- Advanced two step treated sealant technology

TEXTURES



COMB



RESAWN



SMOOTH

Industry leading technology.

Durable coating technology developed by Woodtone in partnership with global coating manufacturer, Sherwin Williams with industry leading performance against mold and mildew growth, as tested by ASTM standards.

SUBSTRATE	Knotty, appearance grade SPF
PROFILES	1" (11/16), 5/4" (1 1/8), 2" (1 1/2)
WARRANTY	25 year no-rot warranty
COATING	Two step treated sealant technology

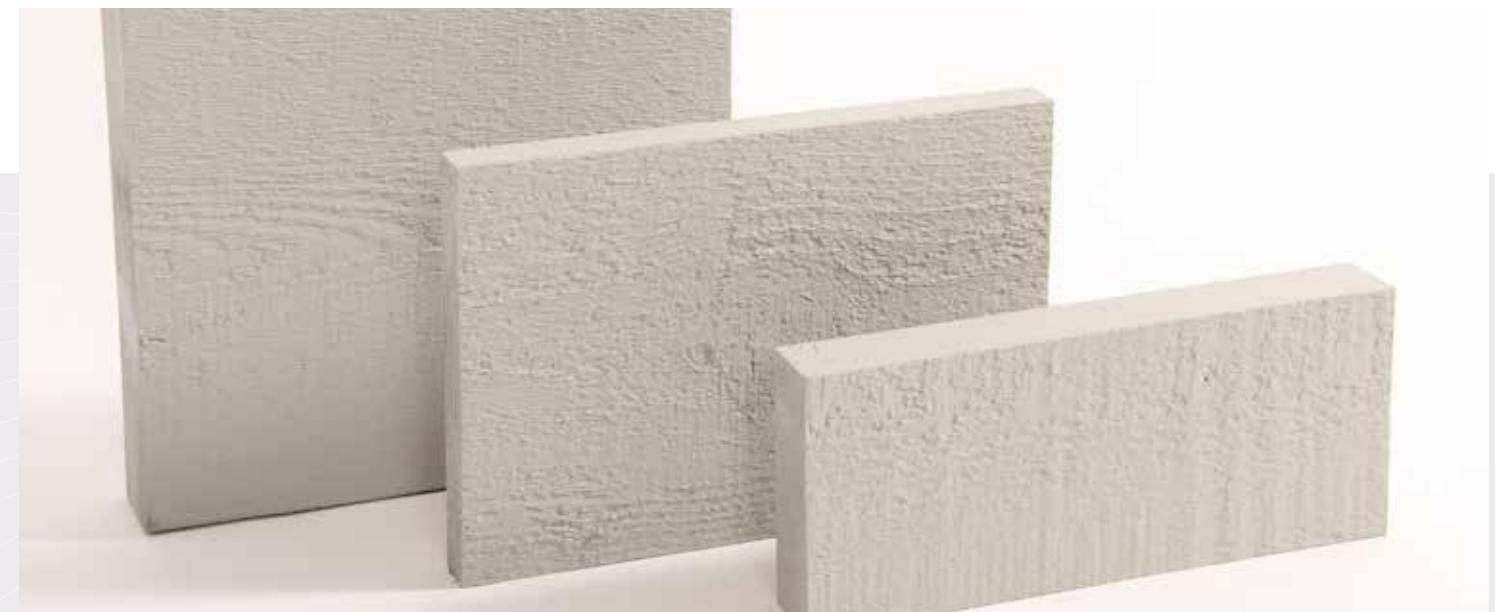

RusticSeries™ Siding Collection

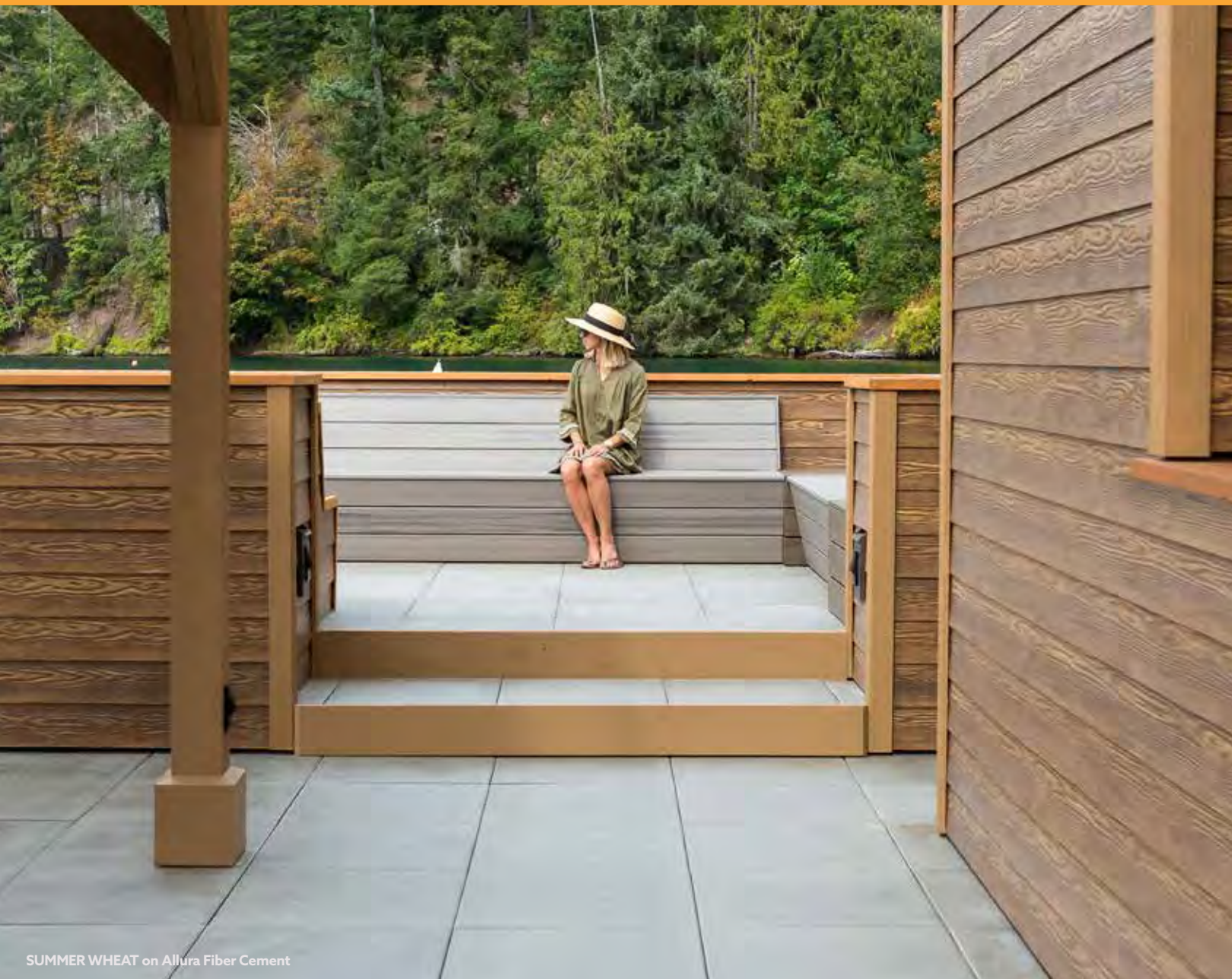

SUMMER WHEAT on Allura Fiber Cement

Composite siding with the appearance of wood.

RusticSeries™ brings you the best of both worlds; the beauty and warmth of real wood on durable fiber cement and composite siding. This two tone factory applied coating system improves the curb appeal of your home, and is warranted for 20 years. RusticSeries™ will shield you from the elements and provide you with a lasting, beautiful siding product for years to come.

- 20 Year Coating Warranty
- 18 Designer Colors
- Lap, shakes and panel profiles available
- Factory coated for consistency and durability

Two-tone perfection.

Create a picture perfect exterior with our eighteen RusticSeries™ colors; select the perfect combination to suit your individual style. RusticSeries colors below are shown with a suggested solid color trim to complete the look.

SUBSTRATE	James Hardie Fiber Cement, Allura Fiber Cement, LP Smartside
PROFILE	Lap siding, panels, shake panels
WARRANTY	20 year coating warranty, plus substrate warranty
COLORS	18 color options

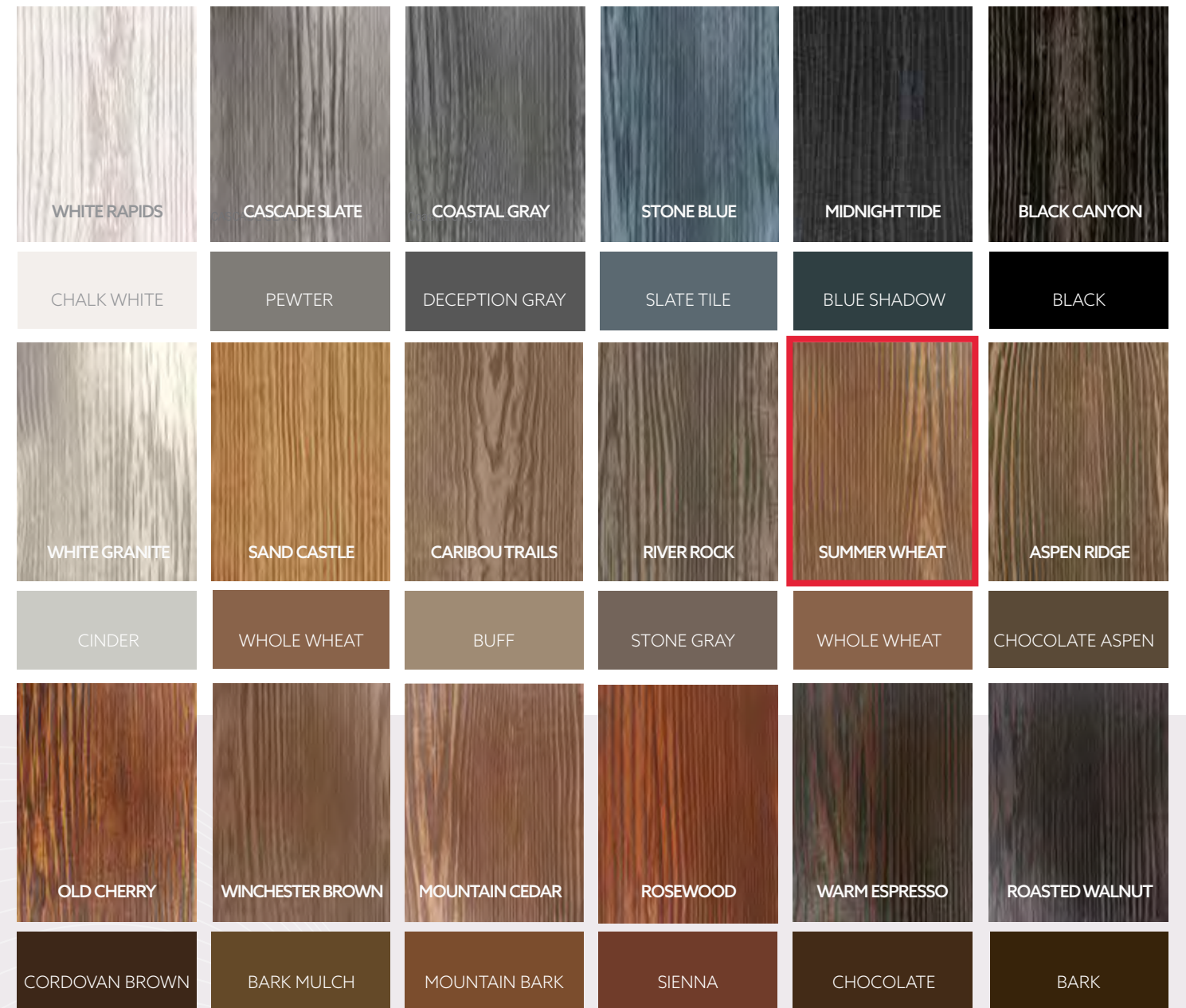

Note: RusticSeries™ replicates the natural beauty of wood. Each substrate and each profile of this product varies in terms of grain pattern and color variance. Due to limitations of the printing process, actual color may vary from the color shown. Refer to a physical sample for approvals.



SHARE



Smooth-Star®



Pulse™ Echo 4-Lite Centered | Style No. S4CL (shown in flat lite frame)

★★★★★ 3.9 (14) [Write a review](#)

5 Available Sizes



VIEW ON HOME

THERMA-TRU VIBRANT PAINT OPTIONS



Looking for more information on finishing options? Check out our [finishing page](#) and learn how you can use finish to make your house a home with Therma-Tru.

GLASS OPTIONS

Clear

DESIGN YOUR DOOR

WHERE TO BUY

ORDER FINISH SAMPLES

Where Home Begins with Therma-Tru doors.

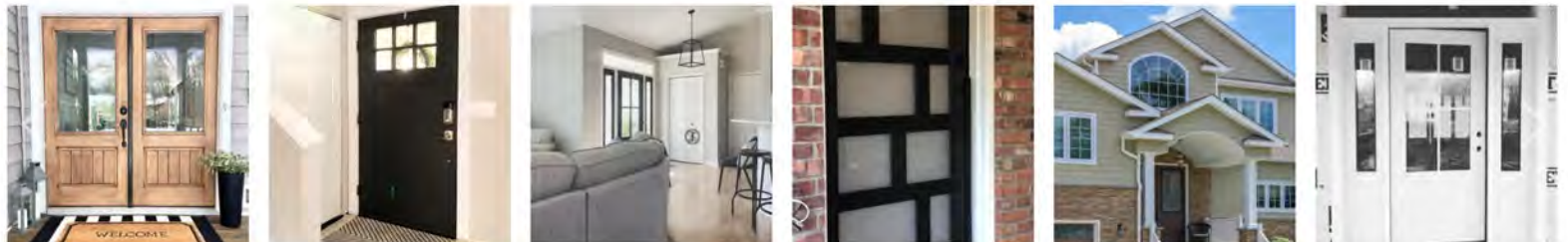

2020 Energy Star® Qualification Chart

Classic-Craft® Opaque & Lip-Lite Fiberglass Doors

GARAGE ENTRY/MECH DOOR- TS210FD



Glass Designs																
6'8" Height Doors																
Glass Size (Inches)	25x66	25x51*	25x42*		21x35	25x35	15x38			10x42			10x8			
Decorative Glass	.26/.27	.26/.27	.23/.20		.21/.15	.21/.15	.21/.15			.18/.08						
Decorative Glass – Wrought Iron	.32/.26	.32/.26	.28/.20													
Privacy & Textured Glass	.26/.27	.26/.27	.23/.20													
Satin Etch						.21/.15										
Low-E Glass	.26/.15	.26/.15	.23/.11		.21/.09	.21/.09	.21/.09			.18/.05			.18/.05			
Opaque*													.14/.01	.18/.01		
Fire Opaque													.19/.00			
8'0" Height Doors																
Glass Size (Inches)		25x66	21x51*	31x51*						8x42	10x42					
Decorative Glass		.26/.27	.26/.27	.26/.27												
Decorative Glass – Wrought Iron		.32/.26	.32/.26	.32/.26												
Privacy & Textured Glass		.26/.27	.26/.27	.26/.27												
Low-E Glass		.26/.15	.26/.15	.26/.15						.18/.05	.18/.05					
Opaque													.14/.01			
Fire Opaque													.19/.00			

*Also includes arch and round top lites or door slabs.

KEY	Indicates Product is Energy Star Qualified in all 50 States	Numbers: U-Factor / Solar Heat Gain Coefficient x: Indicates Product Availability
	Indicates Product is Energy Star Qualified in Northern Zone	
	Indicates Product is NOT Energy Star Qualified	

2020 Energy Star® Qualification Chart

Classic-Craft® Fiberglass Doors Featuring EnLiten™ Flush-Glazed Designs



Glass Designs																				
6'8" Height Doors																				
Glass Size (Inches)	26x66							26x18							8x66	8x52	8x45	8x35	8x41	8x18
Decorative Glass								.22/.15						.22/.15	.19/.08	.19/.08	.19/.08	.19/.08	.19/.08	.19/.08
Privacy & Textured Glass	.30/.28							.22/.15						.22/.15						.19/.08
Satin Etch														.22/.15						
Low-E Glass	.27/.16							.21/.09						.21/.09	.18/.05	.18/.05	.18/.05	.18/.05	.18/.05	.18/.07
8'0" Height Doors																				
Glass Size (Inches)	26x80							30x24	26x18						8x80					
Decorative Glass								.22/.15	.22/.15					.22/.15						
Privacy & Textured Glass	.30/.28							.22/.15	.22/.15					.22/.15						
Low-E Glass	.27/.16							.21/.09	.21/.09					.21/.09						

*Also includes arch and round top lite.

KEY	Indicates Product is Energy Star Qualified in all 50 States	Numbers: U-Factor / Solar Heat Gain Coefficient x: Indicates Product Availability
	Indicates Product is Energy Star Qualified in Northern Zone	
	Indicates Product is NOT Energy Star Qualified	

ROOFTOP DOOR - S118LE

2020 Energy Star® Qualification Chart
Fiber-Classic® & Smooth-Star® Opaque & Lip-Lite Fiberglass Doors



Glass Designs																																												
	6'8" Height Doors				8'0" Height Doors				6'8" Height Doors				8'0" Height Doors				6'8" Height Doors				8'0" Height Doors																							
Glass Size (Inches)	22x64	20x64	16x64	14x64	22x47	22x36**	20x36	22x36	22x27	8x36**	16x40	21x15	8x42R	8x36	22x10A	22x10R	22x6	8x6	7x64	8x47	8x36**	8x44S	22x80	20x80	14x80	22x64	22x47	22x47	21x15	8x36	22x10A	22x10R	8x6	7x80	7x64	8x47								
Decorative Glass	.26/.27	.26/.27	.23/.20		.23/.20	.21/.15	.21/.15	.21/.15	.21/.15	.21/.15	.21/.15	.18/.08	.18/.08	.18/.08	.18/.08			.18/.08					.18/.08	.18/.08	.18/.08	.18/.08	.26/.27	.26/.27			.26x.27	.23/.20		.23/.20			.18/.08	.18/.08	.18/.08		.18/.08	.21/.15	.18/.08	.18/.08
Decorative Glass – Wrought Iron	.32/.26	.32/.26			.28/.20	.25/.15	.25/.15	.25/.15	.25/.15	.25/.15		.20/.08	.20/.08	.20/.08									.20/.08	.20/.08	.20/.08	.20/.08	.32/.26	.32/.26			.32/.26	.28/.20	.28/.20				.20/.08	.20/.08	.20/.08		.25/.15	.20/.08	.20/.08	
Frosted Glass	.32/.30	.32/.30			.28/.23	.25/.17		.25/.17	.25/.17	.25/.17	.24/.17												.20/.09		.20/.09		.32/.30	.32/.30		.25/.17	.28/.23	.25/.17	.25/.17	.25/.17			.20/.09	.20/.09		.20/.09	.20/.09	.20/.09	.20/.09	
Privacy & Textured Glass	.26/.27	.26/.27			.23/.20	.21/.15		.21/.15	.21/.15	.21/.15		.18/.08	.18/.08	.18/.08				.18/.08					.18/.08	.18/.08	.18/.08	.18/.08	.26/.27	.26/.27			.26/.27	.23/.20	.23/.20				.18/.08	.18/.08		.18/.08	.21/.15	.18/.08	.18/.08	
Grilles Between Glass	.34/.26	.34/.26			.28/.20	.25/.15	.25/.15	.25/.15	.25/.15	.25/.15				.20/.08	.20/.08	.20/.08								.20/.08	.20/.08	.20/.08	.20/.08	.34/.26	.34/.26			.34/.26	.28/.20	.28/.20				.20/.08	.20/.08	.20/.08		.24/.15	.20/.08	.20/.08
Low-E Grilles Between Glass	.29/.14	.29/.14			.23/.10	.22/.08	.22/.08	.22/.08	.22/.08	.22/.08				.19/.04	.19/.04	.19/.04								.19/.04	.18/.04	.18/.04	.18/.04	.29/.14	.29/.14			.29/.14	.23/.10	.23/.10				.19/.04	.19/.04	.19/.04		.21/.08	.19/.04	.18/.04
Miniblinds	.36/.25	.36/.25	.30/.18		.30/.18	.26/.14	.26/.14	.26/.14	.26/.14					.21/.07									.21/.06	.21/.06	.21/.06	.21/.06	.36/.25	.36/.25	.30/.18		.36/.25	.30/.18	.30/.18				.21/.07				.26/.14	.21/.06	.21/.06	
Low-E Miniblinds	.31/.21	.31/.21	.27/.15		.27/.15	.24/.12	.24/.12	.24/.12	.24/.12					.20/.06									.20/.06	.20/.06	.20/.06	.20/.06	.31/.21	.31/.21	.27/.15		.31/.21	.27/.15	.27/.15				.20/.06				.24/.12	.20/.06	.20/.06	
Clear	.34/.30	.34/.30		.25/.17	.28/.23	.25/.17	.25/.17	.25/.17	.25/.17		.24/.17		.20/.09	.20/.09	.20/.09		.20/.09	.20/.09					.20/.09	.20/.09	.20/.09	.20/.09	.34/.30	.34/.30	.25/.17	.28/.23	.34/.30	.28/.23	.28/.23				.20/.09	.20/.09		.24/.17	.20/.09	.20/.09		
Low-E Glass	.29/.16	.29/.16	.25/.12	.22/.09	.23/.11	.22/.09	.22/.09	.22/.09	.22/.09		.21/.09	.18/.07	.18/.05	.19/.05	.19/.05	.19/.05	.19/.05	.19/.05					.19/.05	.18/.05	.18/.05	.18/.05	.29/.16	.29/.16	.25/.12	.22/.09	.29/.16	.23/.11	.23/.11		.18/.07	.19/.05	.19/.05	.19/.05	.19/.05	.21/.09	.19/.05	.18/.05		
Opaque																		.14/.01	.17/.01	.18/.01	.18/.01																			.14/.01	.17/.01	.18/.01	.18/.01	
Fire Opaque																			.18/.00	.19/.01	.20/.01	.20/.01																			.18/.00	.19/.01	.20/.01	.20/.01

*Represents shaker panels.
**Also includes arch and round top lite.

KEY	Indicates Product is Energy Star Qualified in all 50 States	Numbers: U-Factor / Solar Heat Gain Coefficient x: Indicates Product Availability
	Indicates Product is Energy Star Qualified in Northern Zone	
	Indicates Product is NOT Energy Star Qualified	

2020 Energy Star® Qualification Chart

Fiber-Classic® & Smooth-Star® Fiberglass Doors
Featuring EnLiten™ Flush-Glazed Designs



Glass Designs												
	6'8" Height Doors											
Glass Size (Inches)	27x64	25x64	21x64	20x64	14x64	25x48	21x48	22x36	23x16	7x64	8x47	8x16
Privacy & Textured Glass	.31/.27	.31/.27		.31/.27		.31/.27	.27/.20		.21/.08	.19/.08		.21/.08
Grilles Between Glass	.34/.26	.34/.26		.34/.26		.34/.26	.29/.20	.25/.15		.20/.08	.20/.08	
Low-E Grilles Between Glass	.28/.15	.28/.15		.28/.15		.28/.15	.25/.10	.22/.08		.18/.04	.18/.04	
Clear	.32/.30	.32/.30		.32/.30	.25/.17	.32/.30	.28/.23	.25/.17		.20/.09	.20/.09	
Low-E Glass	.26/.15	.26/.15		.26/.15	.21/.09	.26/.15	.23/.12	.21/.09	.20/.07	.18/.05		.20/.07
Miniblinds		.36/.25	.36/.25									
Low-E Miniblinds		.31/.21	.31/.21									
8'0" Height Doors												
Glass Size (Inches)		25x80	21x80		14x80	25x64	20x64		23x16	7x80		8x16
Privacy & Textured Glass		.31/.27	.31/.27			.31/.27	.31/.27		.21/.08	.24/.15		.21/.08
Grilles Between Glass		.34/.26	.34/.26			.34/.26	.34/.26					
Low-E Grilles Between Glass		.28/.15	.28/.15			.28/.15	.28/.15					
Clear		.32/.30	.32/.30		.32/.30	.32/.30	.32/.30					
Low-E Glass		.26/.15	.26/.15		.26/.15	.26/.15	.26/.15		.20/.07	.22/.08		.20/.07
Miniblinds		.36/.25	.36/.25									
Low-E Miniblinds		.31/.21	.31/.21									

KEY	Indicates Product is Energy Star Qualified in all 50 States	Numbers: U-Factor / Solar Heat Gain Coefficient x: Indicates Product Availability
	Indicates Product is Energy Star Qualified in Northern Zone	
	Indicates Product is NOT Energy Star Qualified	

2020 Energy Star® Qualification Chart

Fiber-Classic® & Smooth-Star® Impact Rated Fiberglass Doors



Glass Designs													
6'8" Height Doors													
Glass Size (Inches)	22x64	20x64	16x64	14x64	22x47	22x36	20x36	22x36	21x15	8x36	7x64	8x47	8x36
Decorative Glass	.28/.26	.28/.26			.24/.19	.22/.14	.22/.14	.22/.14	.18/.07	.18/.07	.18/.07	.18/.07	.18/.07
Decorative Glass – Wrought Iron	.30/.25	.30/.25			.26/.18	.23/.14		.23/.14	.19/.07	.19/.07	.19/.07	.19/.07	.19/.07
Frosted Glass	.30/.28	.30/.28			.26/.18	.23/.16		.23/.16		.19/.08	.19/.08		.19/.08
Privacy & Textured Glass	.28/.26				.24/.19	.22/.14		.22/.14	.18/.07	.18/.07	.18/.07	.18/.07	.18/.07
Grilles Between Glass	.31/.25	.31/.25		.23/.14	.27/.18	.23/.14		.23/.14		.19/.07	.19/.07	.19/.07	.19/.07
Low-E Grilles Between Glass	.25/.13	.25/.13		.20/.07	.22/.10	.20/.07		.20/.07		.17/.04	.17/.04	.17/.04	.17/.04
Miniblinds	.34/.23	.34/.23	.29/.17		.29/.17	.25/.13					.20/.06	.20/.06	.20/.06
Low-E Miniblinds	.30/.23	.30/.23	.26/.17		.26/.17	.23/.13					.19/.06	.19/.06	.19/.06
Clear Glass	.30/.28	.30/.28		.23/.16	.26/.18	.23/.16	.23/.16	.23/.16		.19/.08	.19/.08	.19/.08	.19/.08
Low-E Glass	.24/.15	.24/.15		.20/.09	.21/.11	.20/.09	.20/.09	.20/.09	.19/.07	.19/.07	.19/.07	.19/.07	.19/.07
8'0" Height Doors													
Glass Size (Inches)	22x80	20x80		14x80	22x64	22x47		22x47	21x15	8x36	7x80	7x64	8x47
Decorative Glass	.28/.26	.28/.26			.28/.26	.24/.19		.24/.19	.18/.07	.18/.07	.22/.14	.18/.07	.18/.07
Decorative Glass – Wrought Iron	.30/.25	.30/.25			.30/.25	.26/.18		.26/.18	.19/.07	.19/.07	.23/.14	.19/.07	.19/.07
Frosted Glass	.30/.28	.30/.28			.30/.28	.26/.18		.26/.18		.19/.08	.23/.16	.19/.08	
Privacy & Textured Glass	.28/.26				.28/.26	.24/.19		.24/.19	.18/.07	.18/.07	.22/.14	.18/.07	.18/.07
Grilles Between Glass	.31/.25	.31/.25			.31/.25	.27/.18		.27/.18		.19/.07	.23/.14	.19/.07	.19/.07
Low-E Grilles Between Glass	.25/.13	.25/.13			.25/.13	.22/.10		.22/.10		.17/.04	.20/.07	.17/.04	.17/.04
Miniblinds	.34/.23	.34/.23			.34/.23	.29/.17					.25/.13	.20/.06	.20/.06
Low-E Miniblinds	.30/.23	.30/.23			.30/.23	.26/.17					.23/.13	.19/.06	.19/.06
Clear Glass	.30/.28	.30/.28		.26/.18	.30/.28	.26/.18		.26/.18		.19/.08	.23/.16	.19/.08	.19/.08
Low-E Glass	.24/.15	.24/.15		.21/.11	.24/.15	.21/.11		.21/.11	.19/.07	.19/.07	.20/.09	.19/.07	.19/.07

Note: Impact-Rated products on this page utilize impact rated glass and structural door slabs.

KEY	Indicates Product is Energy Star Qualified in all 50 States	Numbers: U-Factor / Solar Heat Gain Coefficient x: Indicates Product Availability
	Indicates Product is Energy Star Qualified in Northern Zone	
	Indicates Product is NOT Energy Star Qualified	

2020 Energy Star® Qualification Chart

Steel Opaque & Lip-Lite Doors



Glass Designs																								
6'8" Height Doors																								
Glass Size (Inches)	22x64	20x64	16x64	14x64	22x47	22x36*	20x36	22x27	8x36*	16x40	8x42R	22x10A	22x10R	21x15	22x6	7x18	8x6		7x64	8x47	8x36*	8x44S	8x6	
Decorative Glass	.26/.27	.26/.27	.23/.20		.23/.20	.21/.15	.21/.15		.21/.15	.21/.15	.18/.08	.18/.08	.18/.08	.18/.08			.18/.08		.18/.08	.18/.08	.18/.08	.18/.08	.18/.08	.18/.08
Decorative Glass – Wrought Iron	.33/.26	.33/.26			.28/.20	.25/.15	.25/.15		.25/.15		.20/.08			.20/.08					.18/.08	.20/.08	.20/.08			
Frosted Glass	.34/.30	.34/.30			.28/.23	.26/.17			.26/.17	.25/.17			.20/.09						.20/.09		.20/.09			
Privacy & Textured Glass	.26/.27				.23/.20	.21/.15			.21/.15								.18/.08		.18/.08	.18/.08	.18/.08			.18/.08
Grilles Between Glass	.34/.26				.28/.20	.25/.15			.25/.15			.20/.08	.20/.08						.20/.08	.20/.08	.20/.08			
Low-E Grilles Between Glass	.29/.14	.29/.14			.23/.10	.23/.08			.23/.08			.19/.04	.18/.04						.19/.04	.18/.04	.19/.04			
Miniblinds	.35/.25	.35/.25	.30/.18		.30/.18	.27/.14	.27/.14												.21/.07	.21/.07	.21/.07			
Low-E Miniblinds	.31/.21	.31/.21	.27/.15		.27/.15	.24/.12	.24/.12												.20/.06	.20/.06	.20/.06			
Clear Glass	.34/.30	.34/.30		.26/.17	.28/.23	.26/.17	.26/.17	.26/.17	.26/.17	.25/.17	.20/.09	.20/.09	.20/.09		.20/.09	.20/.09	.20/.09		.20/.09	.20/.09	.20/.09	.20/.09	.20/.09	.20/.09
Low-E Glass	.29/.16	.29/.16	.25/.12	.23/.09	.23/.11	.23/.09	.23/.09	.23/.09	.23/.09	.21/.09	.18/.05	.19/.05	.19/.05	.18/.05	.19/.05	.18/.05	.19/.05		.19/.05	.18/.05	.19/.05	.18/.05	.19/.05	.19/.05
Opaque																		.14/.01						
8'0" Height Doors																								
Glass Size (Inches)	22x80	20x80			22x64	22x47						22x10A			22x6		8x6		7x80					
Decorative Glass	.26/.27	.26/.27			.26/.27	.23/.20						.18/.08					.18/.08		.21/.15					
Decorative Glass – Wrought Iron	.33/.26	.33/.26			.33/.26	.28/.20													.25/.15					
Frosted Glass	.34/.30	.34/.30			.34/.30	.28/.23																		
Privacy & Textured Glass	.26/.27	.26/.27			.26/.27	.23/.20											.18/.08		.21/.15					
Grilles Between Glass	.34/.26	.34/.26			.34/.26	.28/.20						.20/.08							.25/.15					
Low-E Grilles Between Glass	.29/.14	.29/.14			.29/.14	.23/.10						.19/.04							.21/.08					
Miniblinds	.35/.25	.35/.25			.35/.25	.30/.18													.27/.14					
Low-E Miniblinds	.31/.21	.31/.21			.31/.21	.27/.15													.24/.12					
Clear Glass	.34/.30	.34/.30			.34/.30	.28/.23						.20/.09			.20/.09		.20/.09		.25/.17					
Low-E Glass	.29/.16	.29/.16			.29/.16	.23/.11						.19/.05			.19/.05		.19/.05		.21/.09					
Opaque																		.14/.01						

*Also includes arch and round top lite.

KEY	Indicates Product is Energy Star Qualified in all 50 States	Numbers: U-Factor / Solar Heat Gain Coefficient x: Indicates Product Availability
	Indicates Product is Energy Star Qualified in Northern Zone	
	Indicates Product is NOT Energy Star Qualified	

2020 Energy Star® Qualification Chart

Steel Impact Rated Doors



Glass Designs												
6'8" Height Doors												
Glass Size (Inches)	22x64	20x64	16x64	14x64	22x47	22x36	20x36	21x15	8x36	7x64	8x47	8x36
Decorative Glass	.28/.26	.28/.26			.25/.19	.22/.14	.22/.14	.18/.07	.18/.07	.18/.07	.18/.07	.18/.07
Decorative Glass – Wrought Iron	.30/.25				.26/.18	.23/.14		.19/.07	.19/.07	.19/.07	.19/.07	.19/.07
Frosted Glass	.30/.28	.30/.28			.26/.21	.23/.16			.19/.08	.19/.08		.19/.08
Privacy & Textured Glass	.28/.26				.25/.19	.22/.14			.18/.07	.18/.07	.18/.07	.18/.07
Grilles Between Glass	.31/.25	.31/.25			.27/.18	.24/.14			.19/.07	.19/.07		.19/.07
Low-E Grilles Between Glass	.25/.13	.25/.13			.23/.10	.21/.08			.18/.04	.18/.04		.18/.04
Miniblinds	.35/.23	.35/.23	.30/.17		.30/.17	.26/.13	.26/.13			.21/.06	.21/.06	.21/.06
Low-E Miniblinds	.30/.23	.30/.23	.26/.17		.26/.17	.23/.13	.23/.13			.19/.06	.19/.06	.19/.06
Clear Glass	.30/.28	.30/.28		.23/.16	.26/.21	.23/.16	.23/.16		.19/.08	.19/.08	.19/.08	.19/.08
Low-E Glass	.24/.15	.24/.15		.20/.09	.21/.11	.20/.09	.20/.09	.17/.05	.17/.05	.17/.05	.17/.05	.17/.05
8'0" Height Doors												
Glass Size (Inches)	22x80	20x80		14x80		22x47				7x80		
Decorative Glass	.28/.26	.28/.26				.25/.19				.22/.14		
Decorative Glass – Wrought Iron	.30/.25					.26/.18				.23/.14		
Frosted Glass	.30/.28	.30/.28				.26/.21				.23/.16		
Privacy & Textured Glass	.28/.26					.25/.19				.22/.14		
Grilles Between Glass	.31/.25	.31/.25				.27/.18				.24/.14		
Low-E Grilles Between Glass	.25/.13	.25/.13				.23/.10				.21/.08		
Miniblinds	.35/.23	.35/.23				.30/.17				.26/.13		
Low-E Miniblinds	.30/.23	.30/.23				.26/.17				.23/.13		
Clear Glass	.30/.28	.30/.28		.26/.21		.26/.21				.23/.16		
Low-E Glass	.24/.15	.24/.15		.21/.11		.21/.11				.20/.09		

Note: Impact-Rated products on this page utilize impact rated glass.

KEY	Indicates Product is Energy Star Qualified in all 50 States	Numbers: U-Factor / Solar Heat Gain Coefficient x: Indicates Product Availability
	Indicates Product is Energy Star Qualified in Northern Zone	
	Indicates Product is NOT Energy Star Qualified	

2020 Energy Star® Qualification Chart

Pulse® Fiberglass Lip-Lite Doors **ENTRY DOOR - S4L-LE**



Glass Designs								
6'8" Height Doors								
Glass Size (Inches)	21x15	7x64	8x6	8x6	8x6	8x6	8x6	8x6
Decorative Glass	.21/.15	.18/.08	.18/.08	.18/.08	.18/.08	.18/.08	.18/.08	.18/.08
Decorative Glass – Wrought Iron	.25/.15	.20/.08						
Privacy & Textured Glass	.21/.15	.18/.08	.18/.08	.18/.08	.18/.08	.18/.08	.18/.08	.18/.08
Low-E Glass	.22/.14	.19/.05	.19/.05	.19/.05	.19/.05	.19/.05	.19/.05	.19/.05

Glass Designs										
8'0" Height Doors										
Glass Size (Inches)	21x15	7x80	8x6	8x6	8x6	8x6	8x6	8x6	8x6	8x6
Decorative Glass	.26/.27	.21/.15	.18/.08	.18/.08	.18/.08	.18/.08	.18/.08	.18/.08	.18/.08	.18/.08
Decorative Glass – Wrought Iron	.32/.26	.25/.15								
Privacy & Textured Glass	.26/.27	.21/.15	.18/.08	.18/.08	.18/.08	.18/.08	.18/.08	.18/.08	.18/.08	.18/.08
Low-E Glass	.27/.25	.21/.09	.19/.05	.19/.05	.19/.05	.19/.05	.19/.05	.19/.05	.19/.05	.19/.05

KEY	Indicates Product is Energy Star Qualified in all 50 States	Numbers: U-Factor / Solar Heat Gain Coefficient x: Indicates Product Availability
	Indicates Product is Energy Star Qualified in Northern Zone	
	Indicates Product is NOT Energy Star Qualified	

2020 Energy Star® Qualification Chart

Pulse® Fiberglass Impact Rated Doors



Glass Designs	
6'8" Height Doors	
Glass Size (Inches)	7x64
Decorative Glass	.18/.07
Decorative Glass – Wrought Iron	.19/.07
Privacy & Textured Glass	.18/.07
Low-E Glass	.19/.08
8'0" Height Doors	
Glass Size (Inches)	7x80
Decorative Glass	.22/.14
Decorative Glass – Wrought Iron	.23/.14
Privacy & Textured Glass	.22/.14
Low-E Glass	.20/.09

KEY	Indicates Product is Energy Star Qualified in all 50 States	Numbers: U-Factor / Solar Heat Gain Coefficient x: Indicates Product Availability
	Indicates Product is Energy Star Qualified in Northern Zone	
	Indicates Product is NOT Energy Star Qualified	

Note: Impact-Rated products on this page utilize impact rated glass.

2020 Energy Star® Qualification Chart

Pulse® Steel Lip-Lite Doors



Glass Designs								
6'8" Height Doors								
Glass Size (Inches)	21x15	7x64	8x6	8x6	8x6	8x6	8x6	8x6
Decorative Glass	.21/.15	.18/.08	.18/.08	.18/.08	.18/.08	.18/.08	.18/.08	.18/.08
Decorative Glass – Wrought Iron	.25/.15	.20/.08						
Privacy & Textured Glass	.21/.15	.18/.08	.18/.08	.18/.08	.18/.08	.18/.08	.18/.08	.18/.08
Low-E Glass	.22/.14	.19/.05	.19/.05	.19/.05	.19/.05	.19/.05	.19/.05	.19/.05

Glass Designs										
8'0" Height Doors										
Glass Size (Inches)	21x15	7x80	8x6	8x6	8x6	8x6	8x6	8x6	8x6	8x6
Decorative Glass	.26/.27	.21/.15	.18/.08	.18/.08	.18/.08	.18/.08	.18/.08	.18/.08	.18/.08	.18/.08
Decorative Glass – Wrought Iron	.33/.26	.25/.15								
Privacy & Textured Glass	.26/.27	.21/.15	.18/.08	.18/.08	.18/.08	.18/.08	.18/.08	.18/.08	.18/.08	.18/.08
Low-E Glass	.27/.25	.21/.09	.19/.05	.19/.05	.19/.05	.19/.05	.19/.05	.19/.05	.19/.05	.19/.05

KEY	Indicates Product is Energy Star Qualified in all 50 States	Numbers: U-Factor / Solar Heat Gain Coefficient x: Indicates Product Availability
	Indicates Product is Energy Star Qualified in Northern Zone	
	Indicates Product is NOT Energy Star Qualified	

2020 Energy Star® Qualification Chart

Pulse® Steel Impact Rated Doors



Glass Designs	
6'8" Height Doors	
Glass Size (Inches)	7x64
Decorative Glass	.18/.07
Decorative Glass – Wrought Iron	.19/.07
Privacy & Textured Glass	.18/.07
Low-E Glass	.17/.05
8'0" Height Doors	
Glass Size (Inches)	7x80
Decorative Glass	.22/.14
Decorative Glass – Wrought Iron	.23/.14
Privacy & Textured Glass	.22/.14
Low-E Glass	.20/.09

KEY	Indicates Product is Energy Star Qualified in all 50 States	Numbers: U-Factor / Solar Heat Gain Coefficient x: Indicates Product Availability
	Indicates Product is Energy Star Qualified in Northern Zone	
	Indicates Product is NOT Energy Star Qualified	

Note: Impact-Rated products on this page utilize impact rated glass.



LISTING INFORMATION OF Therma Tru 20 Min (with hose) Fiberglass Fire Door PP Model
20PPFFD

SPEC ID: 25358

Therma Tru Corporation
1750 Indian Wood Circle
Maumee, OH 43537

This report is for the exclusive use of Intertek's Client and is provided pursuant to the agreement between Intertek and its Client. Intertek's responsibility and liability are limited to the terms and conditions of the agreement. Intertek assumes no liability to any party, other than to the Client in accordance with the agreement, for any loss, expense or damage occasioned by the use of this report. Only the Client is authorized to permit copying or distribution of this report and then only in its entirety. Any use of the Intertek name or one of its marks for the sale or advertisement of the tested material, product or service must first be approved in writing by Intertek. The observations and test results in this report are relevant only to the sample tested. This report by itself does not imply that the material, product, or service is or has ever been under an Intertek certification program.

Fiberglass Reinforced Faced (Proprietary Core) (Simulated Panel Type or Flush) Swinging Door for installation in up to 20 minute locations (with or without hose stream-see table below). For use in any "Category C - Standard" frames. These doors may also be installed in frames listed in "Category C - Proprietary" in accordance with the frame manufacturer's individual listing. **A fire rated compression weather strip is required.**

Limitations

Cylindrical/Mortise/Deadbolt/Latches with maximum 2-3/4" backset/Card Reader/Surface Mounted Vertical Rod Fire Exit Devices/Rim-Type Fire Exit Devices/Viewers/Protection Plates/Surface Mounted Closers/Surface or Kerf Mounted Door Bottom/ Arch Top and Round Top Door Configurations.

Maximum Size of Openings

Single Swing (**with hose stream**) 3'0" wide x 6'8" high

Standard and Double Egress Pairs - Not Allowed

Testing Standard

UL-10C (Positive Pressure) (2009)
 NFPA 252 (2008)
 CAN4 S104 (1985)

All assemblies are identified by a label or marking bearing the wording, "Listed (Product)", a time interval, temperature rise (if applicable), a serial number and the WHI Certification Mark.

(Unless otherwise specified, all Fire Doors have a nominal thickness of 1-3/4".)

<u>Attribute</u>	<u>Value</u>
CSI Code	08 10 00 Doors and Frames
CSI Code	08 15 00 Plastic Doors
Fire Resistance	20 Min w/Hose Stream PP Cat A Door
Swing	Single Swing
Listed or Inspected	LISTED
Report Number	100354358MID-001
Criteria	CAN4 S104 (1985)
Criteria	NFPA 252 (2008)
Criteria	UL 10(c) (2009)
Intertek Services	Certification
Listing Section	CATEGORY A - DOORS - NO ADDITIONAL EDGE-SEALING SYSTEM REQUIRED



elements of
**OUTDOOR
STYLE**

RED RECTANGLES DENOTE
ARCHITECT'S SELECTIONS



featuring: Enhance Naturals in Foggy Wharf and Transcend Railing



STYLE
PERMEATES
EVERY
HOME.

And at Trex, we believe yours is meant to extend beyond its threshold. That's why we offer a variety of decking and railing collections, furniture and features, so that every family and every budget can experience the warm feeling of belonging. Find that in the pages ahead and then make the *Trex® decision that's right for you™*.

TABLE
of
CONTENTS

SECTION I: DECKING 06

Embrace color with durable, eco-friendly collections of decking.

SECTION II: RAILING 26

Frame your view with long-lasting railing for all tastes and budgets.

SECTION III: EXTRAS 36

Mind the particulars of relaxing and entertaining.

SECTION IV: PRODUCT LISTINGS... 48



SECTION I: DECKING

embrace
C O L O R

What goes with a backyard of a thousand pines? The very thing that does right by snowcaps and sand, too: durable composite boards that allow you to take in nature's every shade of awe.

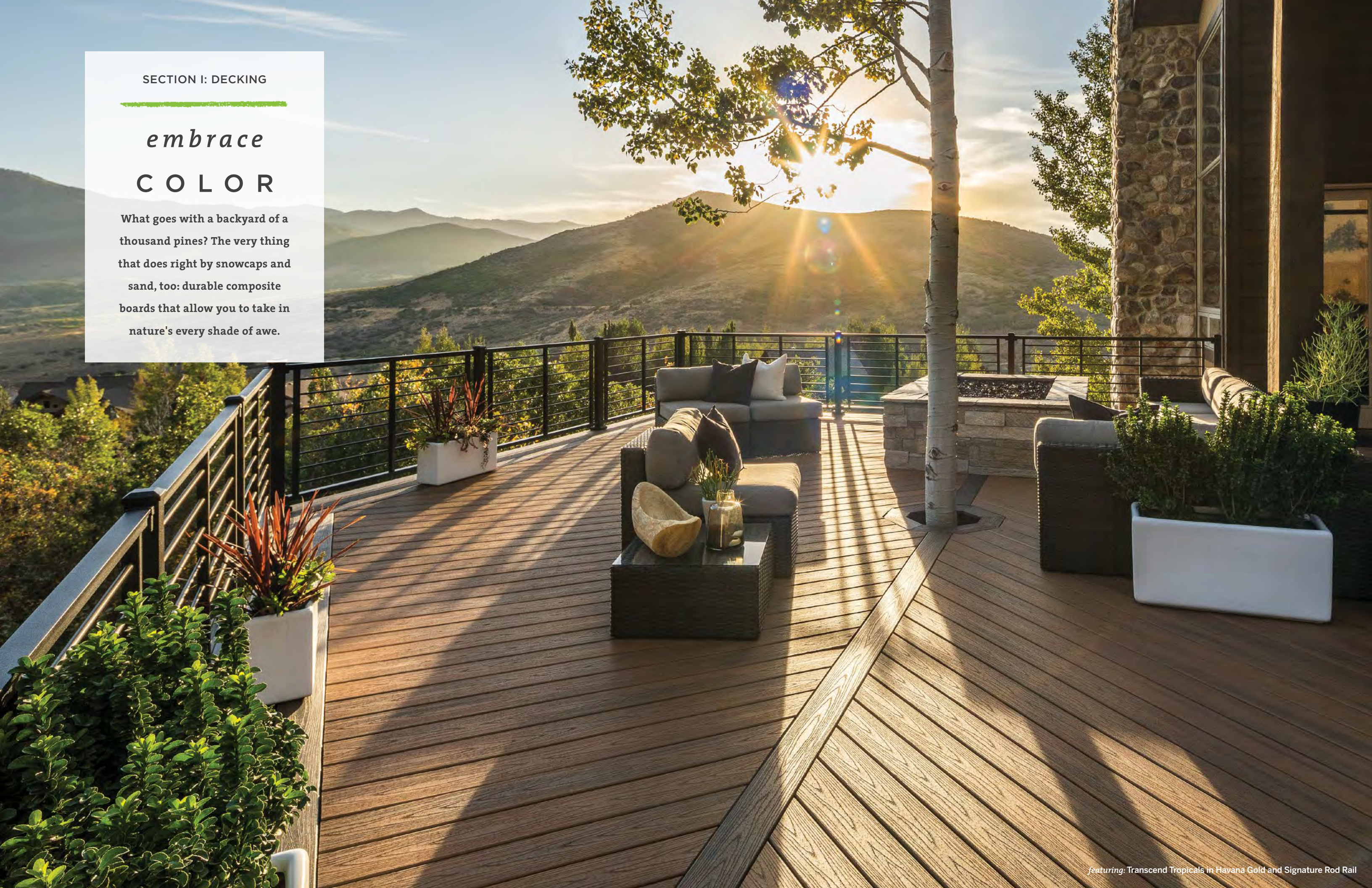

In her
ELEMENT



DINE

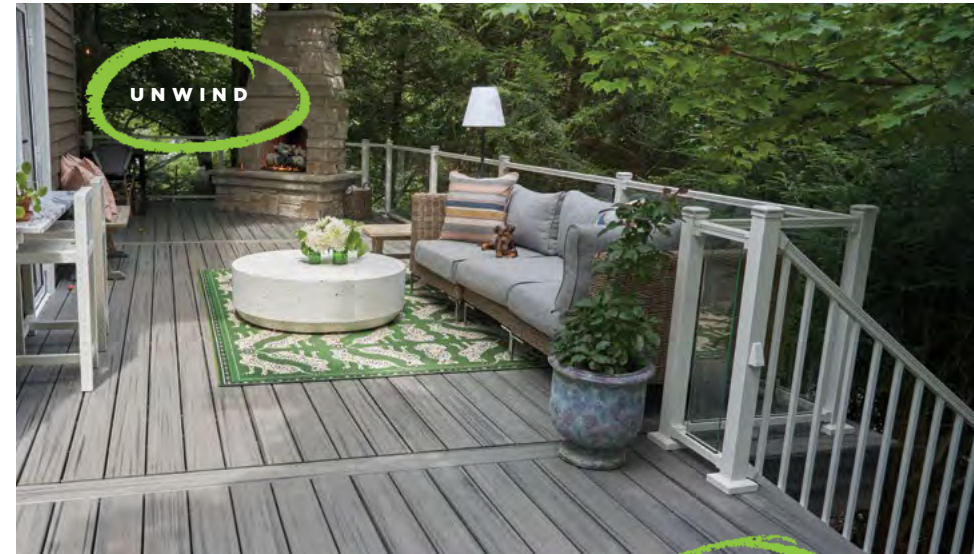

UNWIND



GATHER



COOK

tastemaker
EVETTE RIOS

Enjoying the languid pace of home is not something that lifestyle expert, writer, designer and TV personality Evette Rios takes lightly. So when it came to expanding the Pocono Mountains retreat that she shares with her husband, Stephen, and her two sons, Yago and Rex, the Jane-of-all-trades knew she wanted an outdoor room that not only reflected her colorful personality, but required little of her time when it came to maintenance. Here the style guru shares the ins and outs of her recent Trex deck build.

How did you come to choose Trex for your project?

I try to use sustainable and environmentally friendly products for my home whenever possible. Trex decking was the ideal solution because it is extremely durable and almost completely made of recycled content.

Which Trex decking product did you use?

I chose Trex Transcend in Island Mist. I love it because it has a silvery aged look that works well with the old barn wood around our property. We also used Trex Signature® railing with glass panels, which allowed us to have an uninterrupted view of the trees and visiting birds.

Did anything about Trex surprise you?

I was unsure if it would look like real wood, but Transcend decking looks entirely realistic with its streaks and color variations.

How are you using your outdoor space?

We eat our meals out there, we play out there, and we cook out there, too. Plus, there's a hot tub and a fireplace, so we are spending a lot of time on our Trex deck.

Featured in photos

Transcend Tropicals in Island Mist
Signature Glass & Aluminum Railing
Trex® Outdoor Kitchens™



Trex Enhance®

BASICS

PRICED TO PUT THE PRESSURE
ON TREATED LUMBER

Trex has engineered cost out of the equation with our latest collection of easy-to-build, easy-to-maintain decking. Trex Enhance® Basics melds the durability of composite with the affordability of wood, resulting in long-lasting, worry-free decking.

NEW DEPTHS

There's nothing monotonous about monochromatic color. This perch in *Saddle* showcases the universal appeal of earthy brown.

Perfect for DIYers:
no specialty
tools required

SHOWN IN SADDLE

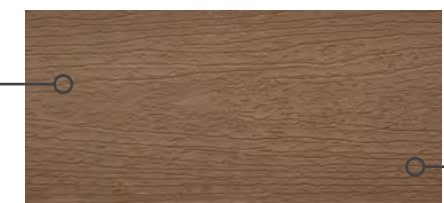

No sanding,
no sealing...ever

BOARD PROFILES

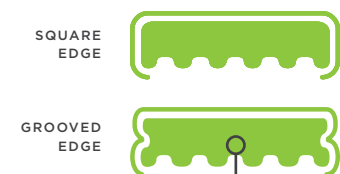

Lightweight,
easy-to-handle
scalloped boards

Use Trex Hideaway® Hidden
Fastening System for a clean,
fastener-free appearance

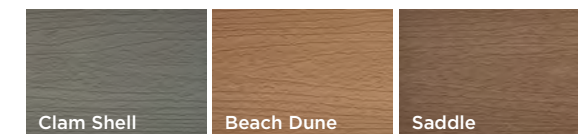

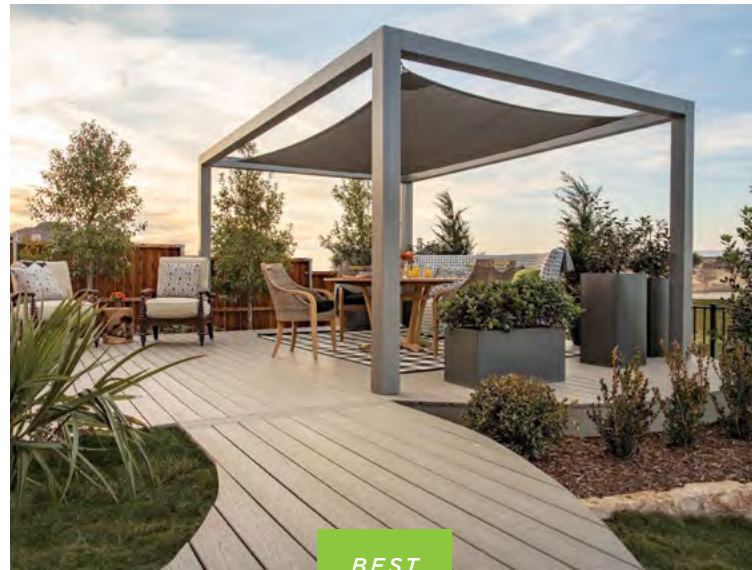
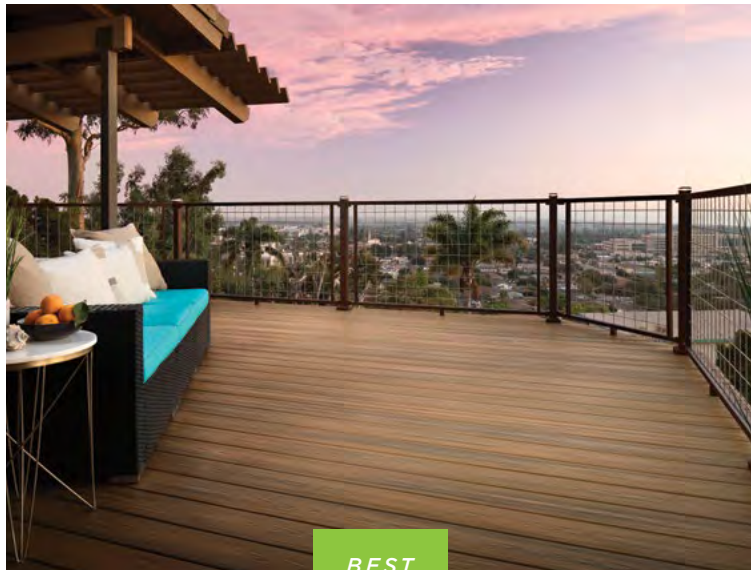

Photos © 2019 Discovery or its subsidiaries and affiliates. All rights reserved.



Trex Transcend® TROPICALS

Elevated aesthetics paired with the highest level of performance.

\$\$\$ █ (25) ★★★★★

Trex Transcend® EARTH TONES

A classic look for uncompromising homes.

\$\$\$ █ (25) ★★★★★

Trex Select® EARTH TONES

The perfect pairing of price and minimal maintenance.

\$\$ █ (25) ★★

Trex Enhance® NATURALS

The beauty of wood with the ease of composite.

\$\$ █ (25) ★

Trex Enhance® BASICS

Priced to put the pressure on treated lumber.

\$ █ (25) ★

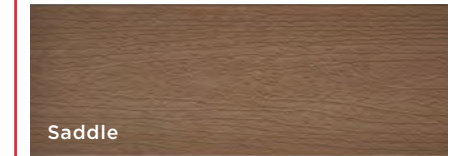
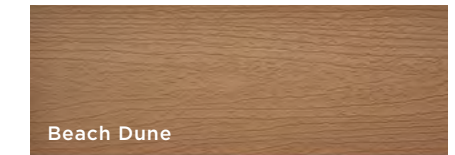
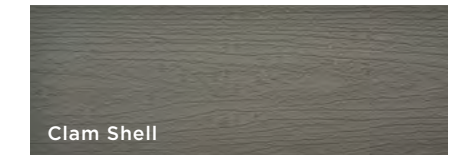
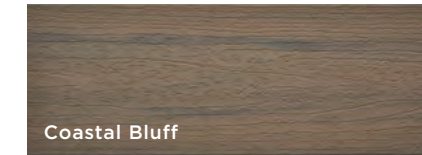
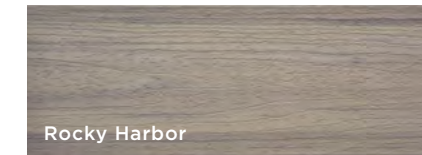
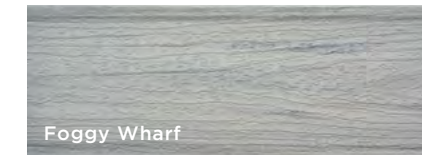
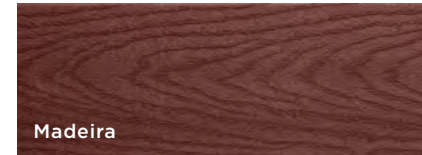
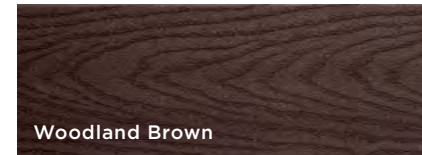
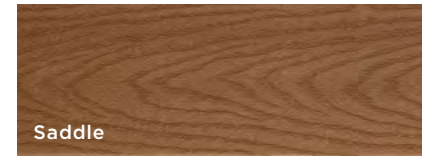
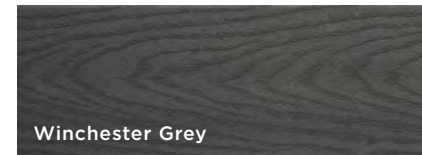
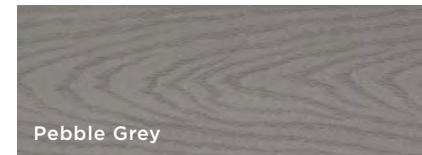
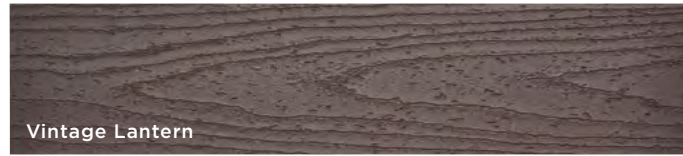
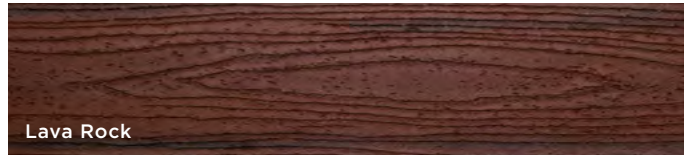

Sample any and every color at order.trex.com

Why WOOD YOU?

Trading up from wood to Trex means ditching hours of annual upkeep that costs way more than you bargain for. Compare the qualities of our high-performance, Made-in-America boards to lumber and ask yourself: *can you afford not to choose Trex?*

TREX WILL



Withstand sun, snow & sleet
HIGH-PERFORMANCE TECHNOLOGY



Clean easily with soap & water
LOW-MAINTENANCE SHELL



Let forestfuls of trees grow and grow
MADE OF 95% RECYCLED MATERIALS IN THE USA



Make good on its promises
25-YEAR LIMITED RESIDENTIAL AND FADE & STAIN WARRANTIES

TREX WON'T

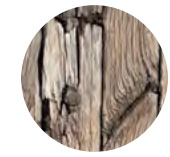

Rot, warp or splinter
UNLIKE WOOD



Need seasonal sealing or staining
UNLIKE WOOD



Become food for termites
UNLIKE WOOD



Fade or stain
UNLIKE WOOD

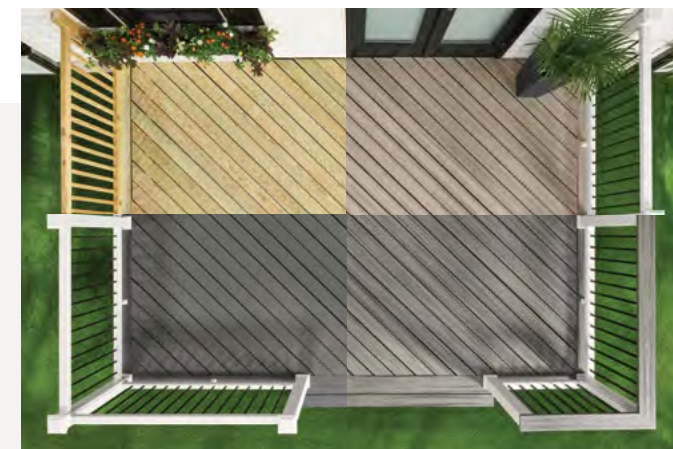

Which Trex and why?
See how our collections stack up to wood at compare.trex.com



GREATER GREEN, GREATER GOOD.

It's a good feeling to be able to take in the view from your deck and know you did your part to protect the world around you.

Trex homeowners experience that sense of contentment over and over again, having chosen eco-friendly composite boards made with clean technology.

 **95%**
recycled content

We repurpose 400,000 tons of plastic film and reclaimed sawdust annually

 **400 MILLION**
pounds of plastic

Diverting this from landfills each year has made Trex one of largest recyclers of plastic film in North America

 **22,000**
trees planted

Each sale of Trex Outdoor Furniture has led to this tally, thanks to our partnership with Trees for the Future





TREX® LIMITED WARRANTY

Trex Company, Inc. (hereinafter "Trex") warrants to the original purchaser ("Purchaser") that, for the period of time set forth in the following sentence, under normal use and service conditions, Trex® product (the "Product") shall be free from material defects in workmanship and materials, and shall not split, splinter, rot or suffer structural damage from termites or fungal decay. The term of such warranty shall be twenty-five (25) years from the date of original purchase for a residential application, and ten (10) years from the date of original purchase for a commercial application. If a defect occurs within the warranty period, Purchaser shall notify Trex in writing and, upon confirmation by an authorized Trex representative of the defect, Trex's sole responsibility shall be, at its option, to either replace the defective Product or refund the portion of the purchase price paid by Purchaser for such defective Product (not including the cost of its initial installation).

For purposes of this warranty, a "residential application" shall refer to an installation of the Product on an individual residence, and a "commercial application" shall refer to any installation of the Product other than on an individual residence.

Notwithstanding the foregoing, (a), the term of the warranty for the LED lights and housing for Trex DeckLighting™ shall be seven (7) years, the term of the warranty for the LED lights and housing for Trex LandscapeLighting™ shall be five (5) years, the term of the warranty for the dimmer, timer and transformer for both shall be three (3) years, and the term of the warranty for the motion controller for both shall be one (1) year, in each case provided that a Trex transformer is used (with no warranty on any components if a Trex transformer is not used), and any other parts or accessories shall not be warranted; (b) with respect to hardware for the Trex Surroundings® gate (gate frame, hinges and screws), the term of the warranty shall be five (5) years, (c) with respect to Trex Decorative Balusters, the term of the warranty covering the paint coating shall be ten (10) years, and shall be prorated in the following manner: 100% replacement for the first five (5) years; and 50% replacement for the next five (5) years, (d) the term of the warranty for Transcend Product used as outdoor cladding shall be twenty-five (25) years for both a residential application and a commercial application, and (e) this warranty shall not apply to Trex Elevations® steel deck framing, Trex Signature® aluminum railing and TrexTrim™ (which each have separate warranties).

TO THE FULLEST EXTENT PERMITTED UNDER THE LAW, THIS WARRANTY SHALL NOT COVER AND TREX SHALL NOT BE RESPONSIBLE FOR COSTS AND EXPENSES INCURRED WITH RESPECT TO THE REMOVAL OF DEFECTIVE PRODUCT OR THE INSTALLATION OF REPLACEMENT MATERIALS, INCLUDING BUT NOT LIMITED TO LABOR AND FREIGHT.

With respect to a residential application, this warranty may be transferred one (1) time, within the five (5) year period beginning from the date of original purchase by the Purchaser, to a subsequent buyer of the property upon

which the Product was originally installed. With respect to a commercial application, this warranty is freely transferable to subsequent buyers of the property upon which the Product was originally installed.

To make a claim under this limited warranty, Purchaser, or the transferee, shall send to Trex, within the warranty period referred to above, a description of the claimed defect and proof of purchase, to the following address:

Trex Company, Inc.
Customer Relations
160 Exeter Drive
Winchester, VA 22603-8605

Trex does not warrant against and is not responsible for any condition attributable to: (1) improper installation of Product and/or failure to abide by Trex's installation guidelines, including but not limited to improper gapping; (2) use of Product beyond normal use and service conditions, or in an application not recommended by Trex's guidelines and local building codes; (3) movement, distortion, collapse or settling of the ground or the supporting structure on which Product is installed; (4) any act of God (such as flooding, hurricane, earthquake, lightning, etc.), environmental condition (such as air pollution, mold, mildew, etc.), staining from foreign substances (such as dirt, grease, oil, etc.), or normal weathering (defined as exposure to sunlight, weather and atmosphere which will cause any colored surface to gradually fade, chalk, or accumulate dirt or stains); (5) variations or changes in color of Product; (6) improper handling, storage, abuse or neglect of Product by Purchaser, the transferee or third parties; or (7) ordinary wear and tear.

No person or entity is authorized by Trex to make and Trex shall not be bound by any statement or representation as to the quality or performance of Product other than as contained in this warranty. This warranty may not be altered or amended except in a written instrument signed by Trex and Purchaser.

TO THE FULLEST EXTENT PERMITTED UNDER THE LAW, UNDER NO CIRCUMSTANCES WILL TREX BE LIABLE FOR INCIDENTAL OR CONSEQUENTIAL DAMAGES, WHETHER SUCH DAMAGES ARE SOUGHT IN CONTRACT, IN TORT (INCLUDING BUT NOT LIMITED TO NEGLIGENCE AND STRICT LIABILITY) OR OTHERWISE, AND TREX'S LIABILITY FOR NON-PERSONAL INJURY CLAIMS WITH RESPECT TO DEFECTIVE PRODUCT SHALL IN NO EVENT EXCEED THE REPLACEMENT OF SUCH PRODUCT OR REFUND OF THE PURCHASE PRICE, AS DESCRIBED ABOVE.

Some States or Provinces do not allow the exclusion or limitation of incidental or consequential damages, so the above limitation or exclusion may not apply to you. This warranty gives you specific legal rights, and you may also have other rights that vary from State to State or Province to Province.

Copyright © 2019 Trex Company, Inc.



TREX TRANSCEND®, TREX ENHANCE®, TREX SELECT® AND TREX® UNIVERSAL FASCIA LIMITED FADE & STAIN WARRANTY

For the term set forth below, Trex Company, Inc. (hereinafter "Trex") warrants to the original end-user purchaser (the "Purchaser") that Trex Transcend® decking, porch or fascia, Trex Enhance® decking or fascia, Trex Select® decking or fascia or Trex Universal Fascia, as the case may be (the "Product") will perform, under normal use and service conditions, as follows:

Term of Warranty: The term of this warranty shall begin on the date of original purchase, and shall end (1) twenty-five (25) years thereafter for a residential application of the Product, and (2) ten (10) years thereafter for a commercial application of the Product. Notwithstanding the foregoing, the term of this warranty for Transcend Product used as outdoor cladding shall be twenty-five (25) years for both a residential application and a commercial application.

Residential/Commercial Application: For purposes of this warranty, a "residential application" shall refer to an installation of the Product on an individual residence, and a "commercial application" shall refer to any installation of the Product other than on an individual residence.

Fade Resistance: The Product shall not fade in color from light and weathering exposure as measured by color change of more than 5 Delta E (CIE) units.

The Product is designed to resist fading. No material is fade proof when exposed to years of UV exposure and the elements. The Product is designed to resist fading, and will not in any event fade by more than 5 Delta E (CIE) units.

Stain Resistance: The Product shall be resistant to permanent staining resulting from spills of food and beverage items including ketchup, mustard, salad oils, tea, wine, coffee, fruit punch, barbeque sauce, grease, sodas and other food and beverage related items that would typically be present on a residential deck, or mold and mildew naturally occurring in the environment, provided that such substances are removed from the Product with soap and water or mild household cleaners within one (1) week of exposure of the food or beverage to the surface or first appearance of the mold and mildew.

Notwithstanding the foregoing, Trex does not warrant that the Product is stain-proof, and does not warrant stain resistance resulting from spilled or otherwise applied food and beverage substances which are not properly cleaned as provided above within one (1) week of exposure. In addition, materials not covered in the stain resistant warranty include abrasive compounds of acidic or basic pH, paints or stains, strong solvents, metallic rust or other abnormal deck use items, and non-food and non-beverage substances, including but not limited to, biocides, fungicides, plant food, or bactericides. Mold and mildew can settle and grow on any outdoor surface, including this Product. You should periodically clean your deck to remove dirt and pollen that can feed mold and mildew. This warranty does not cover mold and mildew which is not properly cleaned as provided above within one (1) week of first appearance.

Standard Trex Company Limited Warranty: This warranty is in addition to the standard Trex Company Limited Warranty that applies to all Trex products.

Transferability: With respect to a residential application, this warranty may be transferred one (1) time, within the five (5) year period beginning from the date of original purchase by the Purchaser, to a subsequent buyer of the property upon which the Trex products were originally installed. With respect to a commercial application, this warranty is freely transferable to subsequent buyers of the property upon which the Trex products were originally installed.

EXCLUSIONS FROM WARRANTY COVERAGE:

Exposure to Heat: Direct or indirect contact with extreme heat sources (over 275 degrees) may cause fading and may damage the surface of the Product, and any effects of such exposure are expressly excluded from coverage under this warranty.

Surface Damage: Never use metal shovels or sharp-edged tools to remove snow and ice on the surface of the Product. If the surface of the Product is damaged or punctured, this warranty will be voided.

Paint or Other Materials Applied to the Product: If paint or other coating materials are applied to the Product, this warranty will be voided.

Railing: This warranty does not cover Trex Transcend®, Trex Enhance® or Trex Select® railing components.

Other Exclusions: This warranty shall not cover any condition attributable to: (1) improper installation of the Product and/or failure to abide by Trex's installation guidelines, including but not limited to improper gapping; (2) use of the Product beyond normal use or service conditions, or in an application not recommended by Trex's guidelines and local building codes; (3) movement, distortion, collapse or settling of the ground or the supporting structure on which the Product is installed; (4) any act of God (such as flooding, hurricane, earthquake, lightning, etc.); (5) improper handling, storage, abuse or neglect of the Product by Purchaser, the transferee or third parties; (6) any fading or staining not on the walking surface of the Product (i.e., the underside or the ends of the Product); or (7) ordinary wear and tear.

Procedure for Making a Claim under this Warranty

In order to make a claim under this warranty, Purchaser must do the following:

1. If the Purchaser is making a claim relating to the warranty on stain resistance, Purchaser must do as follows:

(a) Purchaser must try to clean the affected area of the deck by using the cleaning procedures described above within one (1) week of exposure of the food or beverage to the Product or first appearance of the mold and mildew.

(b) If the affected area remains reasonably unsatisfactory after Purchaser has tried these cleaning procedures, then Purchaser must have the affected area of the deck professionally cleaned at Purchaser's expense.

(c) If the affected area remains reasonably unsatisfactory after the professional cleaning, Purchaser may make a claim under this warranty, provided that such claim is made within thirty (30) days after the professional cleaning.

2. To make a claim under this limited warranty, Purchaser, or the transferee, shall send to Trex, within the warranty period referred to above, a description and photographs of the affected area of the Product, proof of purchase, and if the claim relates to the warranty on stain resistance, proof of compliance with paragraph 1. above, to the following address:

Trex Company, Inc.
Customer Relations
160 Exeter Drive
Winchester, VA 22603-8605

3. Upon confirmation by an authorized Trex representative of a valid claim hereunder, Trex's sole responsibility shall be, at its option, to either replace the affected item or refund the portion of the purchase price paid by Purchaser for such affected item (not including the cost of its initial installation).

Replacement material will be provided that is as close as possible in color, design and quality as the replaced material, but Trex does not guarantee an exact match as colors and design may change.

4. If a valid warranty claim hereunder is made during years eleven (11) through twenty-five (25) after the original purchase for a residential application, recovery will be prorated. If Trex is providing replacement materials, it may elect to replace the percentage listed below of boards otherwise meeting the requirements for a claim, or if it is refunding the purchase price, it may elect to refund the percentage listed below of the purchase price of boards otherwise meeting the requirements for a claim.

YEAR OF WARRANTY CLAIM	PERCENTAGE RECOVERY
11	80%
12	80%
13	80%
14	60%
15	60%
16	60%
17	40%
18	40%
19	40%
20	20%
21	20%
22	20%
23	10%
24	10%
25	10%

5. TO THE FULLEST EXTENT PERMITTED UNDER THE LAW, THIS WARRANTY SHALL NOT COVER AND TREX SHALL NOT BE RESPONSIBLE FOR COSTS AND EXPENSES INCURRED WITH RESPECT TO THE REMOVAL OF AFFECTED PRODUCT OR THE INSTALLATION OF REPLACEMENT MATERIALS, INCLUDING BUT NOT LIMITED TO LABOR AND FREIGHT.

No person or entity is authorized by Trex to make and Trex shall not be bound by any statement or representation as to the quality or performance of Trex products other than as contained in this warranty. This warranty may not be altered or amended except in a written instrument signed by Trex and Purchaser.

TO THE FULLEST EXTENT PERMITTED UNDER THE LAW, UNDER NO CIRCUMSTANCES WILL TREX BE LIABLE FOR INCIDENTAL OR CONSEQUENTIAL DAMAGES, WHETHER SUCH DAMAGES ARE SOUGHT IN CONTRACT, IN TORT (INCLUDING BUT NOT LIMITED TO NEGLIGENCE AND STRICT LIABILITY) OR OTHERWISE, AND TREX'S LIABILITY FOR NON-PERSONAL INJURY CLAIMS WITH RESPECT TO PRODUCTS SHALL IN NO EVENT EXCEED THE REPLACEMENT OF SUCH PRODUCTS OR REFUND OF THE PURCHASE PRICE, AS DESCRIBED ABOVE.

Some States or Provinces do not allow the exclusion or limitation of incidental or consequential damages, so the above limitation or exclusion may not apply to you. This warranty gives you specific legal rights, and you may also have other rights that vary from State to State or Province to Province.

Copyright © 2019 Trex Company, Inc.



TREX SIGNATURE® RAILING LIMITED WARRANTY

Trex Company, Inc. (hereinafter "Trex") warrants to the original purchaser ("Purchaser") that, under normal use and service conditions, Trex Signature® Railing (the "Product") shall, for a period of twenty-five (25) years from the date of original purchase, be free from material defects in workmanship and materials. If a defect occurs within the warranty period, Purchaser shall notify Trex in writing and, upon confirmation by an authorized Trex representative of the defect, Trex's sole responsibility shall be, at its option, to either replace the defective Product or refund the portion of the purchase price paid by Purchaser for such defective Product (not including the cost of its initial installation).

With respect to installations where the atmosphere is influenced by a body of salt water (or other contaminant conditions), failure to adhere to the cleaning guidelines available at www.trex.com will void this warranty with respect to any condition resulting from such failure.

TO THE FULLEST EXTENT PERMITTED UNDER THE LAW, THIS WARRANTY SHALL NOT COVER AND TREX SHALL NOT BE RESPONSIBLE FOR COSTS AND EXPENSES INCURRED WITH RESPECT TO THE REMOVAL OF DEFECTIVE PRODUCT OR THE INSTALLATION OF REPLACEMENT MATERIALS, INCLUDING BUT NOT LIMITED TO LABOR AND FREIGHT.

This warranty may be transferred one (1) time, within the five (5) year period beginning from the date of original purchase by the Purchaser, to a subsequent buyer of the property upon which the Product was originally installed.

To make a claim under this limited warranty, Purchaser, or the transferee, shall send to Trex, within the warranty period referred to above, a description of the claimed defect and proof of purchase, to the following address:

Trex Company, Inc.
Customer Relations
160 Exeter Drive
Winchester, VA 22603-8605

Trex does not warrant against and is not responsible for any condition attributable to: (1) improper installation of the Product; (2) use of the Product beyond normal use and service conditions, or in an application not recommended by Trex's guidelines and local building codes; (3) movement, distortion, collapse or settling of the ground or the supporting structure on which the Product is installed; (4) damages attributable to fire, violent storms, earthquake or other Acts of God, accidents, vandalism, or other casualties, impact of objects, or exposure to atmospheric pollutants or conditions other than natural weather processes, (5) improper handling, storage, abuse or neglect of the Product by Purchaser, the transferee or third parties; or (6) ordinary wear and tear.

No person or entity is authorized by Trex to make and Trex shall not be bound by any statement or representation as to the quality or performance of Trex products other than as contained in this warranty. This warranty may not be altered or amended except in a written instrument signed by Trex and Purchaser.

TO THE FULLEST EXTENT PERMITTED UNDER THE LAW, UNDER NO CIRCUMSTANCES WILL TREX BE LIABLE FOR INCIDENTAL OR CONSEQUENTIAL DAMAGES, WHETHER SUCH DAMAGES ARE SOUGHT IN CONTRACT, IN TORT (INCLUDING BUT NOT LIMITED TO NEGLIGENCE AND STRICT LIABILITY) OR OTHERWISE, AND TREX'S LIABILITY FOR NON-PERSONAL INJURY CLAIMS WITH RESPECT TO DEFECTIVE PRODUCTS SHALL IN NO EVENT EXCEED THE REPLACEMENT OF SUCH PRODUCTS OR REFUND OF THE PURCHASE PRICE, AS DESCRIBED ABOVE.

Some States or Provinces do not allow the exclusion or limitation of incidental or consequential damages, so the above limitation or exclusion may not apply to you. This warranty gives you specific legal rights, and you may also have other rights that vary from State to State or Province to Province.

Copyright © 2020 Trex Company, Inc.

Go step-by-step with our helpful

ONLINE TOOLS

1. GET A SENSE OF COLOR & COSTS

Color Selector
Find a hue that says "you" at colors.trex.com

Decking & Railing Duos
Select a pre-styled pairing at duos.trex.com

Cost Calculator
Estimate the price of your deck at price.trex.com

2. DETERMINE SIZE & SHAPE

Deck Starter
Design your deck in three clicks at getstarted.trex.com

Deck Designer
Get a shareable blueprint with our virtual reality tool at 3Ddesign.trex.com

3. SECURE SAMPLES & GET MOVING

Board Samples
Compare and contrast footlong boards at order.trex.com

Trex Locator
Find nearby retailers at find.trex.com

TrexPro® Locator
Find a local, pre-approved contractor at pros.trex.com



@TrexCompany

SHARE YOUR BUILD

Tag your photos with **#trexdecking** to be featured on our Instagram feed.



Appendix B: System Components and Drawings

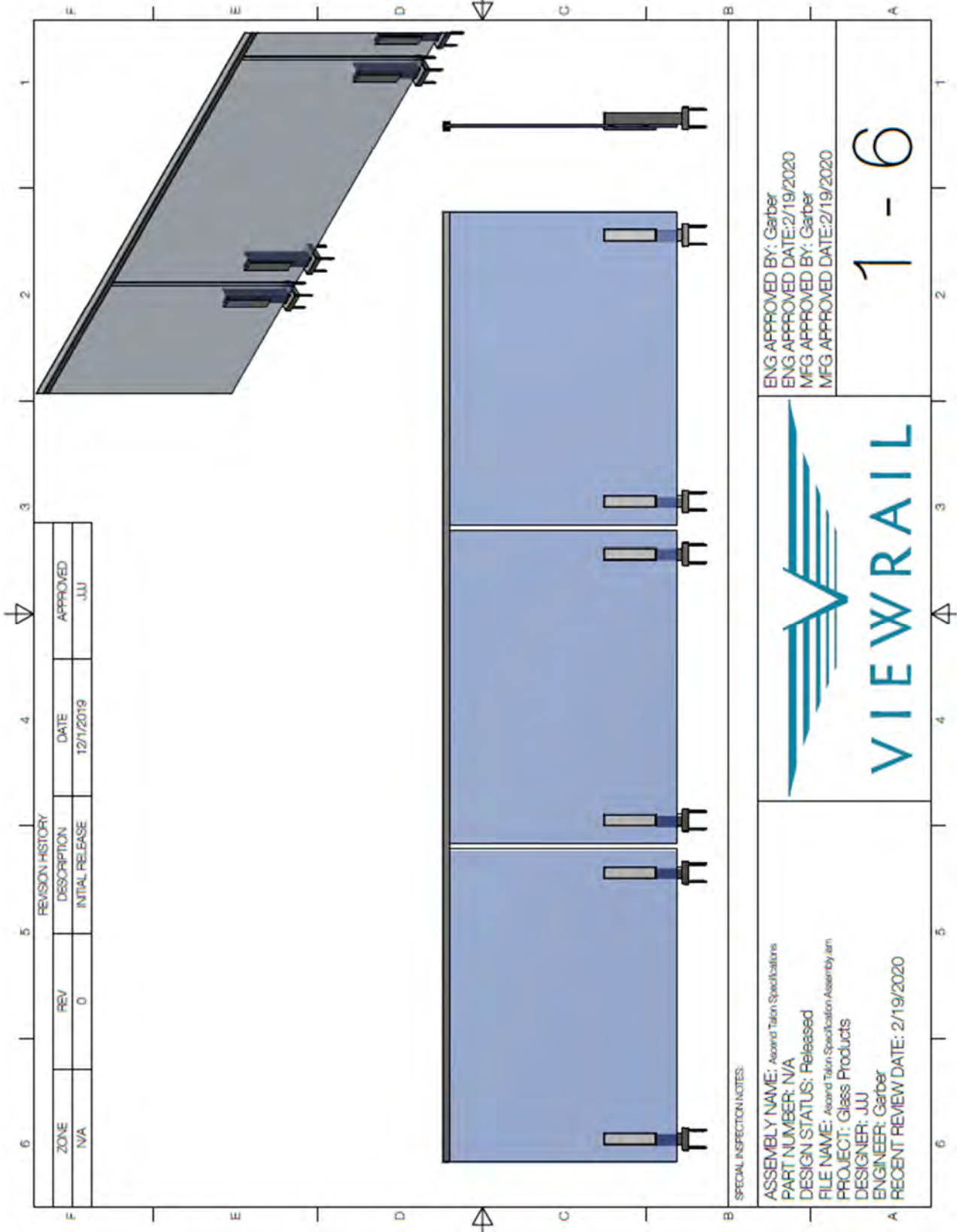

Ascend Talon-Standard Foot Glass Baluster Test Report

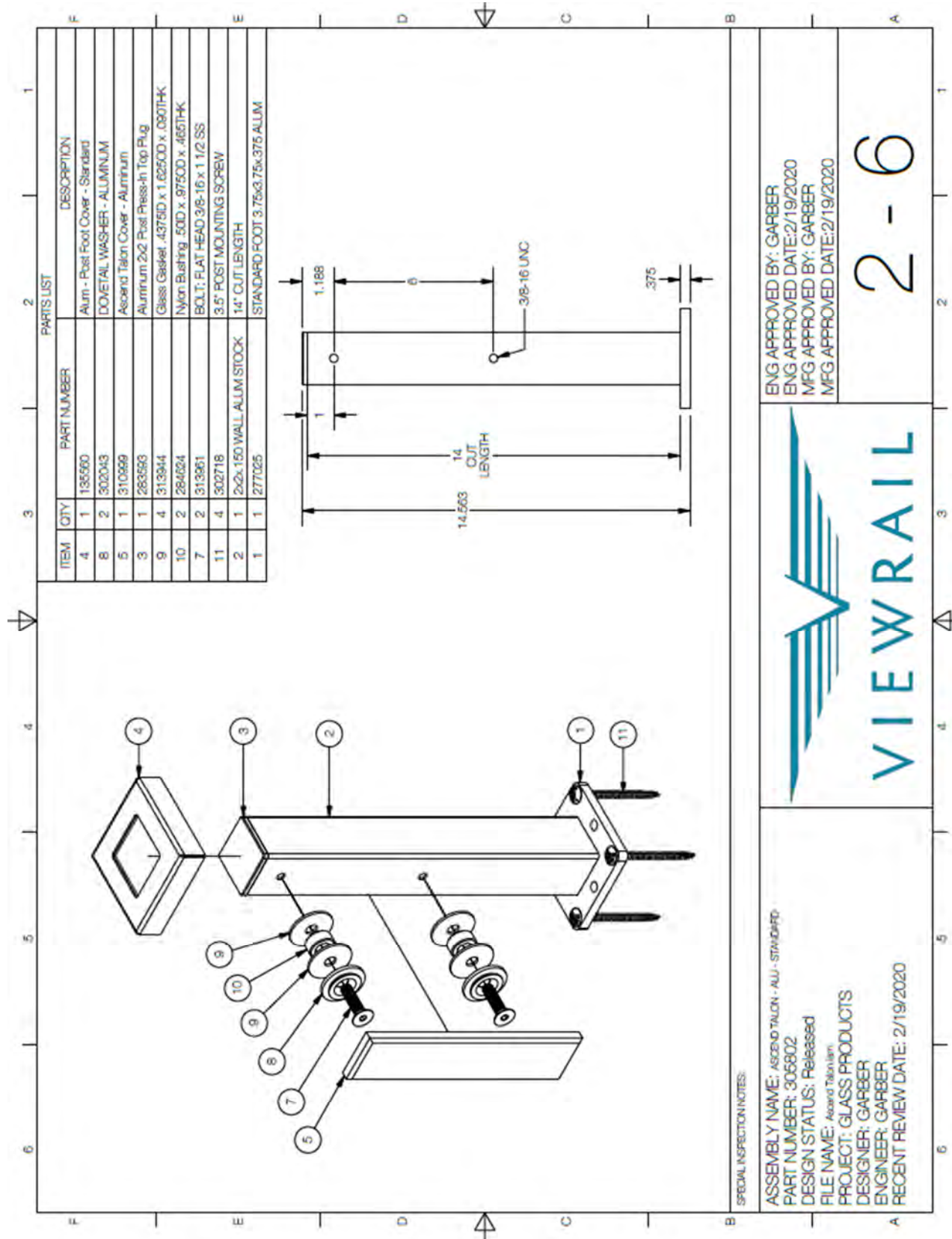

Ascend Talon-Standard Foot Glass Baluster Test Report

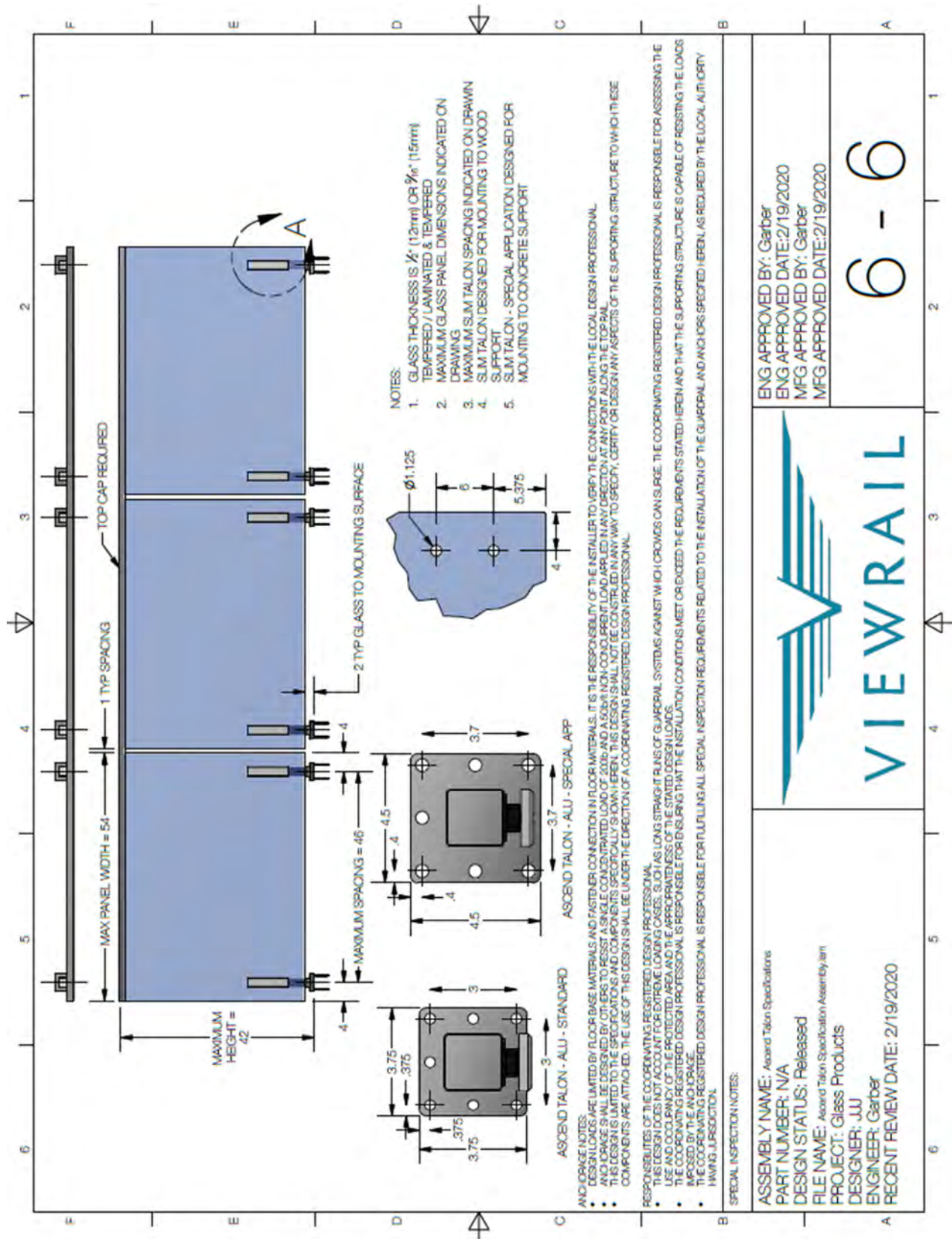

Appendix C: Manufacturer's Published Installation Instructions



Ascend Talons Installation Guide

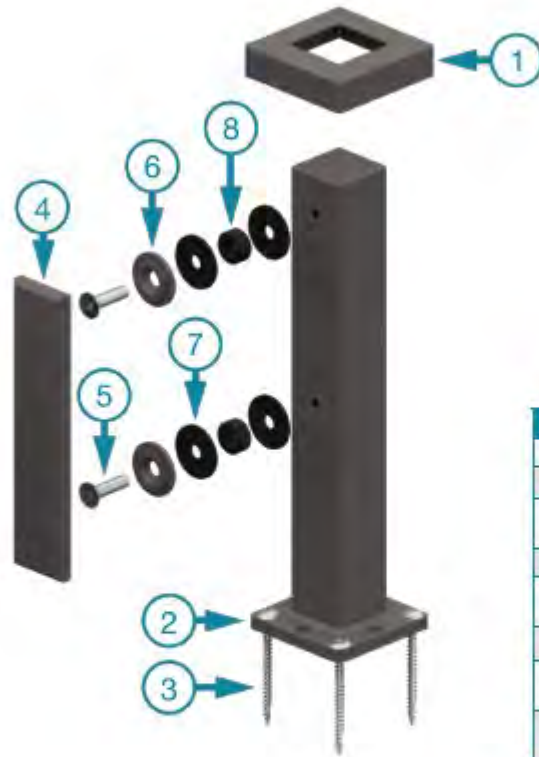

ID#	Part Name
1	Foot Cover
2	Foot
3	Post Mounting Screw 3 1/2" - SS
4	Ascend Talon Cover
5	3/8-16 x 1 1/2 Hex Flat Head Bolt - SS
6	Dovetail Washer
7	Glass Gasket .4375ID x 1.625OD x .090THK
8	Nylon Bushing .50ID x .875OD x .465THK

Before You Begin

Be sure the install site's measurements match the provided drawing.

Items You'll Need

3/8 Hex Key
Drill
Drill Bit - 1/8" to 7/32" *For Wood*
T25 Drive Bit
Silicone
Level

For more information or installation help, go to www.youtube.com/Viewrail

viewrail.com

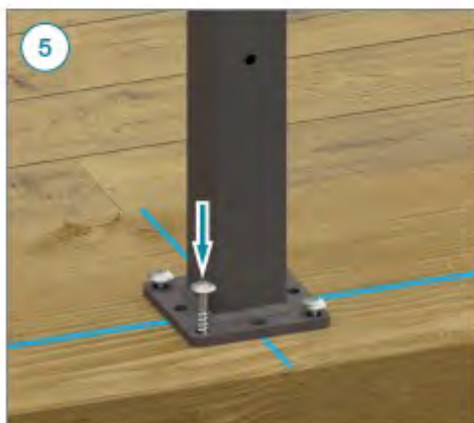
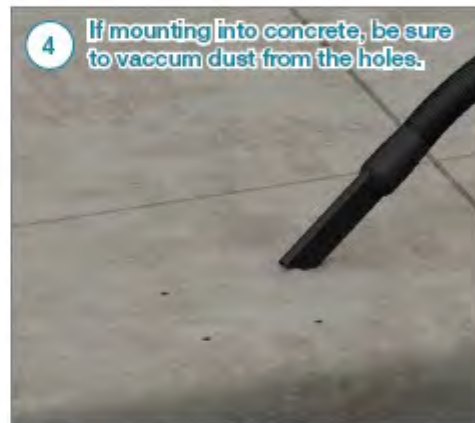
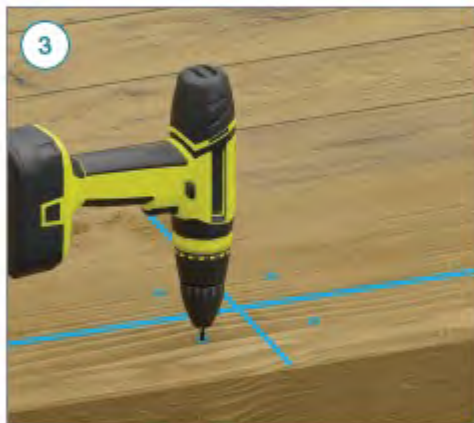
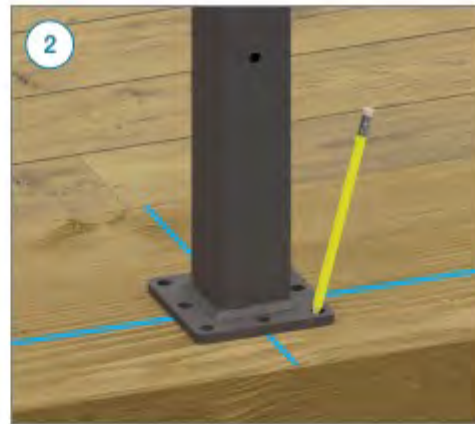
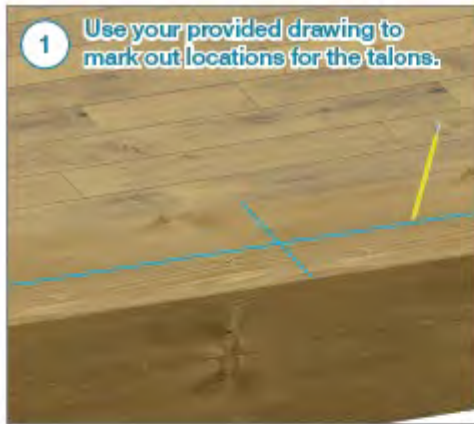

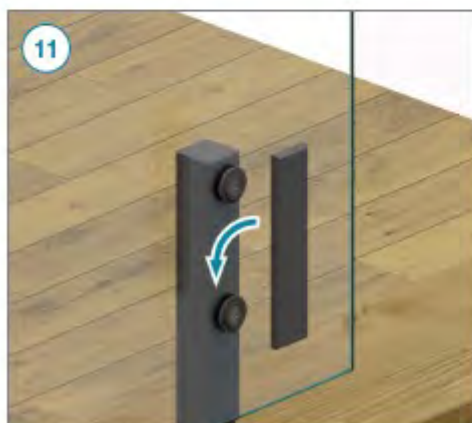
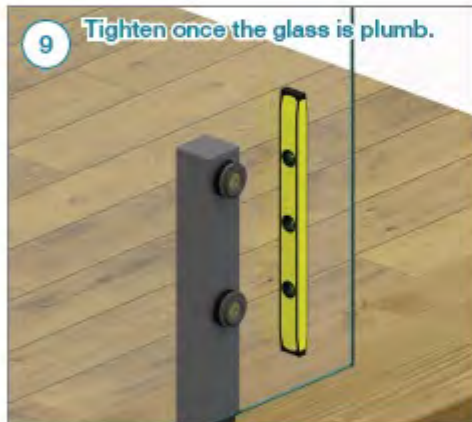
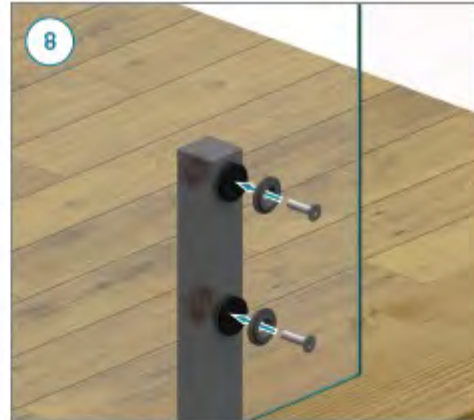



Congratulations! Your Install is Done

We'd love to see your work! Snap a few pics with your phone and send them to pictures@Viewrail.com. Thanks for choosing Viewrail. Enjoy your new installation!



IN MATTE BLACK FINISH

Project	
Type	
Ordering #	
Comments	

1 Light Outdoor Wall Cylinder in BA 9234BA (Brushed Aluminum)

Product Description:

This one light, Wall Cylinder features our Brushed Aluminum finish and uses a BR-30 bulb that produces 65-watts (max.) of pure light. It measures 7" high, is U.L. listed for wet location, and is a Dark Skies compliant fixture.

Available Finishes

Architectural Bronze
Brushed Aluminum
White

+ ADD TO PROJECT

Technical Information

Weight:	0.95 LBS
Safety Rated:	Wet
HCWO:	3.50"
Base Backplate:	5.00"
Width:	4.75"
Height:	7.00"
Lamp Included:	Not Included
Extension:	7.00"
Voltage:	120V
CFL Bulb Type:	HYBRID (13-15W)
Light Source:	Incandescent
Socket Base:	Medium
Number of Bulbs:	1
Lamp Type:	A19
Max Watt:	65W
Finish:	Brushed Aluminum