

DENALI - TWIN SIGN STAR STYLE 'C' LED

IP66 RATED

DATE: _____ PROJECT: _____ TYPE: _____

CATALOG NUMBER LOGIC:



*Requires Safety Cable (SC).

**Accommodates up to 2 lens/shielding media.

CATALOG NUMBER LOGIC

Example: ST - 36 - C - DE - LED - x58 - SP - SAP - 12 - 11 - B - SC

MATERIAL

Aluminum

SERIES

ST - Twin Sign Star

STEM LENGTH

24" (Standard), 30", 36", *42", or *48"

STYLE

C - Straight Mount

FIXTURE

DE - Denali Series

SOURCE

LED - Chip on Board Technology

LED TYPE

x58 - 12W/2700K/80CRI x62 - 20W/3000K/80CRI x66 - 27W/4000K/80CRI

x59 - 12W/3000K/80CRI x63 - 20W/4000K/80CRI x67 - 27W/2700K/90CRI

x60 - 12W/4000K/80CRI x64 - 27W/2700K/80CRI x68 - 27W/3000K/90CRI

x61 - 20W/2700K/80CRI x65 - 27W/3000K/80CRI x69 - 27W/3500K/80CRI

OPTICS

SP - Spot (15°) FL - Flood (35°) WFL - Wide Flood (60°)

FINISH (See page 2 for full-color swatches)

Standard Finishes (BZP, BZW, BLP, BLW, WHP, WHW, SAP, VER)

Premium Finish (ABP, AMG, AQW, BCM, BGE, BPP, CAP, CMG, CRI, CRM, HUG, MDS, NBP, OCP, RMG, SDS, SMG, TXF, WCP, WIR)

Also available in RAL Finishes

LENS TYPE**

9 - Clear (Standard)

10 - Spread 12 - Soft Focus 13 - Rectilinear

SHIELDING**

11 - Honeycomb Baffle

CAP STYLE

A - 45°

B - 90°

C - Flush

D - 45° Less Weephole (Interior use only)

E - 90° Less Weephole (Interior use only)

OPTIONS

SC - Safety Cable with Mounting Canopy (Req. with 42" and above)



TITLE 24, JA8 COMPLIANT

B-K LIGHTING

MADE IN THE USA

559.438.5800 | INFO@BKLIGHTING.COM | BKLIGHTING.COM

THIS DOCUMENT CONTAINS PROPRIETARY INFORMATION OF B-K LIGHTING, INC. AND ITS RECEIPT OR POSSESSION DOES NOT CONVEY ANY RIGHTS TO REPRODUCE, DISCLOSE ITS CONTENTS, OR TO MANUFACTURE, USE OR SELL ANYTHING IT MAY DESCRIBE. REPRODUCTION, DISCLOSURE OR USE WITHOUT SPECIFIC WRITTEN AUTHORIZATION OF B-K LIGHTING, INC. IS STRICTLY FORBIDDEN.

11/01/2021 SKU-1065
SUB-2341-00

DATE: _____ PROJECT: _____ TYPE: _____

SIDE VIEW

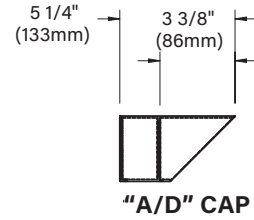
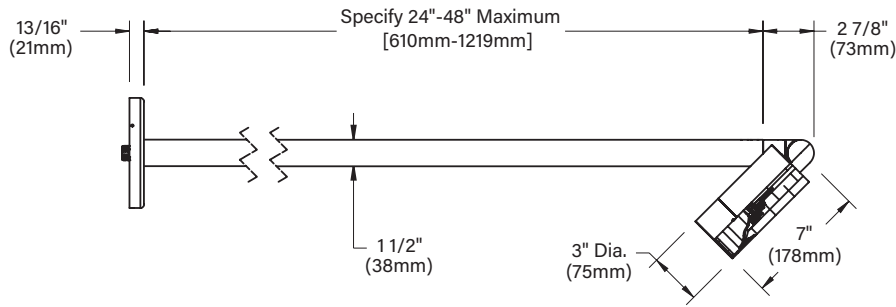

BOTTOM VIEW

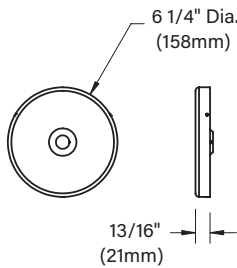
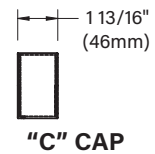
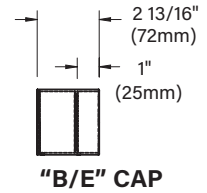
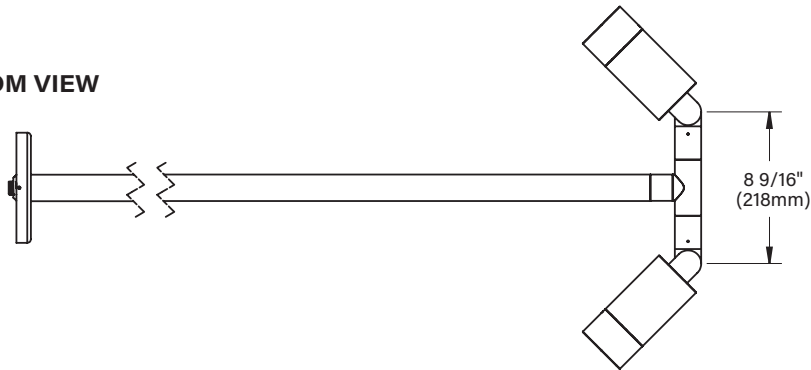

COVER DETAIL

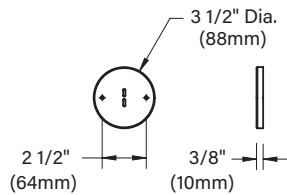

Standard w/ 42" & 48" lengths
Optional w/ 24", 30" & 36" lengths

SAFETY CABLE W/MOUNTING CANOPY

STANDARD FINISHES



[Click Here](#) to view larger, full-color swatches of all available finishes on our website.

PREMIUM FINISHES

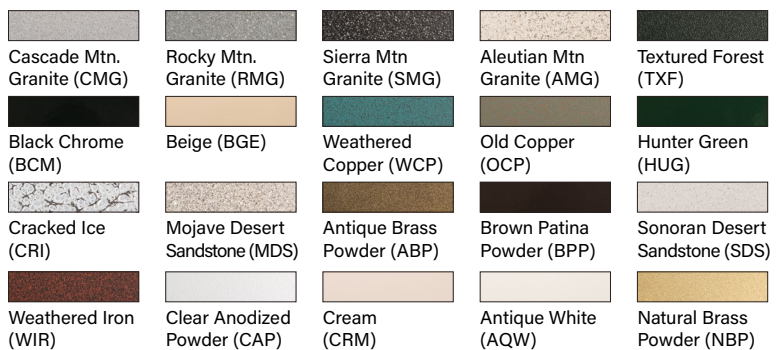

DATE:	PROJECT:	TYPE:
-------	----------	-------

ACCESSORIES (Configure separately)

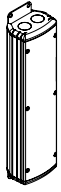

PM2DRM

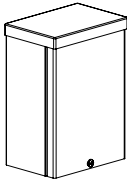

DRM

SPECIFICATIONS

ELECTRICAL	WATTAGE	12W, 20W, or 27W LED
	WIRING	Teflon® coated, 18AWG, 600V, 250°C rated and certified to UL 1659 standard.
	REMOTE DRIVER	For use with remote LED driver. See remote driver submittal to determine remote distance and wiring requirements prior to detailing field installation of any remote wiring.
PHYSICAL	MATERIALS	Furnished in copper-free aluminum (6061-T6).
	STYLE	C style features straight profile with machined adapter for 90° transition from fixture to stem.
	BODY	Unibody design is fully machined from solid billet and provides enclosed, water-proof wireway and integral heat sink for maximum component life. Integral knuckle for maximum mechanical strength. High temperature, silicone 'O' Ring provides water-tight seal. Anti-condensation and corrosion vent equalizes fixture pressure and eliminates potential for damage to internal components.
	KNUCKLE	Patented 360HD mounting system features a mechanical taper-lock, which allows a full 180° vertical adjustment without the use of aim-limiting serrated teeth. High temperature, silicone 'O' Ring provides water-tight seal and compressive resistance to maintain fixture position. Design withstands 73 lbs. static load prior to movement to ensure decades of optical alignment. 1/2" pipe thread for mounting. Biaxial source control provides 360° horizontal rotation in addition to vertical adjustment. Aim & Lock technology allows precision adjustment without the redundant tightening and loosening of knuckle screw.
	CAP	Fully machined and accommodates two (2) lens or louver media.
	LENS	Shock-resistant, tempered glass lens is factory adhered to fixture cap and provides hermetically sealed optical compartment.
	LED	Integrated solid state system and modular design with electrical quick disconnects is scalable for field upgrade and maintenance. LM-80 certified. Title 24, JA8 compliant. Minimum 50,000 hour rated life at 70% of initial lumens (L70). BKSSL technology provides long life, significant energy reduction and exceptional thermal management.
	COLOR MANAGEMENT	Corrected cold phosphor technology delivers near-perfect natural white light. Long term phosphor maintenance over product life. Exact color point conformity exceeds ANSI C78.377 standard. Provides uniform beam with no color variation over angle. Module exceeds 80 CRI (RA>80, R9>16).
	OPTICS	Interchangeable, color-coded OPTIKIT modules permit field changes to optical distribution.
	INSTALLATION	6 1/4" dia., machined canopy permits mounting to 4" octagonal junction box. Junction box installation must be designed to hold full fulcrum weight of fixture (junction box and gasket by others). Optional safety cable with mounting canopy maintains secondary support (standard with 42" and 48" lengths).
	HARDWARE	Tamper-resistant, stainless steel hardware. LOCK aiming screw and canopy mounting screws are black oxide treated for additional corrosion resistance.
	FINISH	StarGuard, our 15-stage chromate-free process cleans and conversion coats aluminum components prior to application of Class 'A' TGIC polyester powder coating and is RoHS compliant. Powder coat or metal finish options available for brass material and metal finish option only for stainless steel material.
	WARRANTY	5-year limited warranty.
CERTIFICATION & LISTING	UL tested to IESNA LM-79. UL listed. Certified to CAN/CSA/ANSI standards. RoHS compliant. Title 24, JA8 compliant. Suitable for indoor or outdoor use, in wet locations, and for installation within 4' of the ground. IP66 Rated. Made in the USA with sustainable materials.	



B-K LIGHTING	MADE IN THE USA	559.438.5800 INFO@BKLIGHTING.COM BKLIGHTING.COM
---------------------	------------------------	--

LAMP & DRIVER DAT (page 1 of 2)

DATE:	PROJECT:	TYPE:
-------	----------	-------

DRIVER ELECTRICAL DATA

Type	LED Type	AC Input Range	Frequency Hz	Power Factor At Full Load (Efficiency)	THD	InRush Current	Operating Current	Operation Ambient Temperature	Dimmer Type	Dimmer Range
INC	x58-x63	105-305Vac	50/60	> 0.94	≤5%	< 250mA	700mA	-30° C ~ 50°C	Incandescent	10-100%
INC	x64-x66	105-305Vac	50/60	> 0.94	≤5%	< 250mA	700mA	-30° C ~ 50°C	TRIAC/ELV, (120 Only)	10-100%
010	x64-x66	120-277Vac	50/60	> 0.90	<20%	6A	700mA	-30° C ~ 70°C	0-10, (120 only)	10-100%

LM79 DATA

OPTICAL DATA

BK No.	CCT (Typ.)	CRI (Typ.)	Input Watts (Typ.)	L70 Data	Angle	CBCP	Del. Lumens Per Side	Multiplier
x58	2700	80	12	50,000	15	3,865	721	0.85
x58	2700	80	12	50,000	35	1,493	661	0.85
x58	2700	80	12	50,000	60	627	623	0.85
x59	3000	80	12	50,000	15	4,048	756	0.89
x59	3000	80	12	50,000	35	1,564	692	0.89
x59	3000	80	12	50,000	60	657	653	0.89
x60	4000	80	12	50,000	15	4,561	851	
x60	4000	80	12	50,000	35	1,762	780	
x60	4000	80	12	50,000	60	740	736	
x61	2700	80	20	50,000	15	7,103	1,307	0.91
x61	2700	80	20	50,000	35	2,623	1,125	0.91
x61	2700	80	20	50,000	60	1,049	1,064	0.91
x62	3000	80	20	50,000	15	7,478	1,376	0.96
x62	3000	80	20	50,000	35	2,761	1,184	0.96
x62	3000	80	20	50,000	60	1,104	1,120	0.96
x63	4000	80	20	50,000	15	7,800	1,435	
x63	4000	80	20	50,000	35	2,880	1,235	
x63	4000	80	20	50,000	60	1,152	1,168	
x64	2700	80	27	50,000	15	15,656	1,767	0.92
x64	2700	80	27	50,000	35	4,649	1,586	0.92
x64	2700	80	27	50,000	60	1,515	1,383	0.92
x65	3000	80	27	50,000	15	16,132	1,820	0.95
x65	3000	80	27	50,000	35	4,791	1,634	0.95
x65	3000	80	27	50,000	60	1,561	1,426	0.95
x66	4000	80	27	50,000	15	17,042	1,923	
x66	4000	80	27	50,000	35	5,061	1,726	
x66	4000	80	27	50,000	60	1,649	1,506	
x67	2700	90	27	50,000	15	16,167	1,824	1.03
x67	2700	90	27	50,000	35	4,801	1,637	1.03
x67	2700	90	27	50,000	60	1,564	1,429	1.03
x68	3000	90	27	50,000	15	16,659	1,880	1.03
x68	3000	90	27	50,000	35	4,947	1,687	1.03
x68	3000	90	27	50,000	60	1,612	1,472	1.03

B-K LIGHTING

MADE IN THE USA

559.438.5800 | INFO@BKLIGHTING.COM | BKLIGHTING.COM

THIS DOCUMENT CONTAINS PROPRIETARY INFORMATION OF B-K LIGHTING, INC. AND ITS RECEIPT OR POSSESSION DOES NOT CONVEY ANY RIGHTS TO REPRODUCE, DISCLOSE ITS CONTENTS, OR TO MANUFACTURE, USE OR SELL ANYTHING IT MAY DESCRIBE. REPRODUCTION, DISCLOSURE OR USE WITHOUT SPECIFIC WRITTEN AUTHORIZATION OF B-K LIGHTING, INC. IS STRICTLY FORBIDDEN.

LAMP & DRIVER DAT (page 2 of 2)

DATE:

PROJECT:

TYPE:

OPTICS

Optic	Angle
Spot	15°
Flood	35°
Wide Flood	60°

B-K LIGHTING

MADE IN THE USA

559.438.5800 | INFO@BKLIGHTING.COM | BKLIGHTING.COM

THIS DOCUMENT CONTAINS PROPRIETARY INFORMATION OF B-K LIGHTING, INC. AND ITS RECEIPT OR POSSESSION DOES NOT CONVEY ANY RIGHTS TO REPRODUCE, DISCLOSE ITS CONTENTS, OR TO MANUFACTURE, USE OR SELL ANYTHING IT MAY DESCRIBE. REPRODUCTION, DISCLOSURE OR USE WITHOUT SPECIFIC WRITTEN AUTHORIZATION OF B-K LIGHTING, INC. IS STRICTLY FORBIDDEN.