

STANLEY'S

Historic District Commission Submission

LEAD



Project Narrative

The existing building of the former Stanley Hong's Mannia Café, located at 249/265 E Baltimore Avenue, is a historic modernist landmark, originally designed by Nathan Johnson, a prominent black architect in the city of Detroit. The structure, a unique example of Google-style design has a distinctive swooping cast concrete facade facing Baltimore Avenue (south) and the parking lot (west). Painted concrete walls face the east and rear alley (north). The building was originally built as a Chinese food restaurant for the Hong family, was used as an occasional hip hop venue during the 1990s and as a church until the early 2010s, and has sat empty since 2013.

Based on photographic evidence from the opening day in 1971, the cast concrete was painted white, while the exposed aggregate bays were unfinished. The concrete masonry was painted a light beige to match the general tone of the exposed aggregate infill. The building is currently painted black on all four facades, and has graffiti along the east and rear facades. The front corner entry has two doors flanking a distinctive corner window with diagonal steel mullions.

The interior of the building is completely gutted of all finishes. The steel beams and columns of the existing roof remain in fair condition, however the roof decking has failed in multiple locations. An exhaustive study of the existing façade panels and infill has not yet been undertaken, but some cracking and damage is evident.

The project will renovate this stunning architectural landmark into a new world class performing arts venue for the city of Detroit, restoring the historic materials, coloration, fixtures, and exterior lighting. The new program for the building will be a main venue with a 700 ticket capacity, a smaller lounge-style venue with a 125 ticket capacity, and a 30 seat restaurant.

To accommodate the performing arts venue, some additions and

modifications to the existing building will be undertaken. The current interior ceiling height of 11' is insufficient for a venue of this size and type. To increase the interior ceiling height to the 20' required to underside of structure, a new rooftop addition set back 15' and 22' respectively from the primary facades. The corresponding portion of the floor slab will also be lowered 2' for additional height. The rooftop addition consists of feathered panels clad in synthetic stucco with an overlay of expanded metal mesh to create a backdrop which enhances the existing form and materiality of the historic building.

A 1,818 square foot addition will be created on a 20' wide empty portion of the lot to the east. This addition will house the smaller lounge-style venue as well as a large bathroom block for both venues. The addition steps back 10' from the historic front façade and draws a diagonal line from the existing building's parapet up to its full required height, in deference to the existing massing.

The restaurant, located in the westernmost portion of the historic building, will open up two of the exposed aggregate bays to let in views and natural light consistent with contemporary restaurant design. The bays will be infilled with a custom glass storefront following the form of the parabolic arch, each with a double entry door at the center.

The renovation and additions seek to celebrate the exuberance and grace of the former Stanley Hong's Mannia Café. While simpler in form and materiality than the historic architecture, the new additions express a complementary formal geometry, rhythm, and tactility to the existing. By restoring and reinvigorating Nathan Johnson's brilliant design with harmonious contemporary additions, the project will breathe new life into this important architectural and cultural icon in the city of Detroit.

Project Scope

Demolition

- Demolish existing non-historic and poorly maintained concrete block additions at rear alley
- Demolish roof and internal structure as required to raise roof
- Demolish interior slab on grade to lower floor

Restoration

- Existing concrete historic facades to remain and be repaired as needed
- Restore historic finishes, colors, and exterior lighting
- Restore existing windows and doors

Construction + Renovation

- New rooftop addition set back from the historic front and west facades
- 1,818 SF addition to the east
- 306 SF addition at the rear
- New custom storefront infill in 2 arch bays on west facade
- Egress doors as required by code

Not Included for Review at this time

- Signage
- Exterior Lighting
- Sitework & exterior improvements

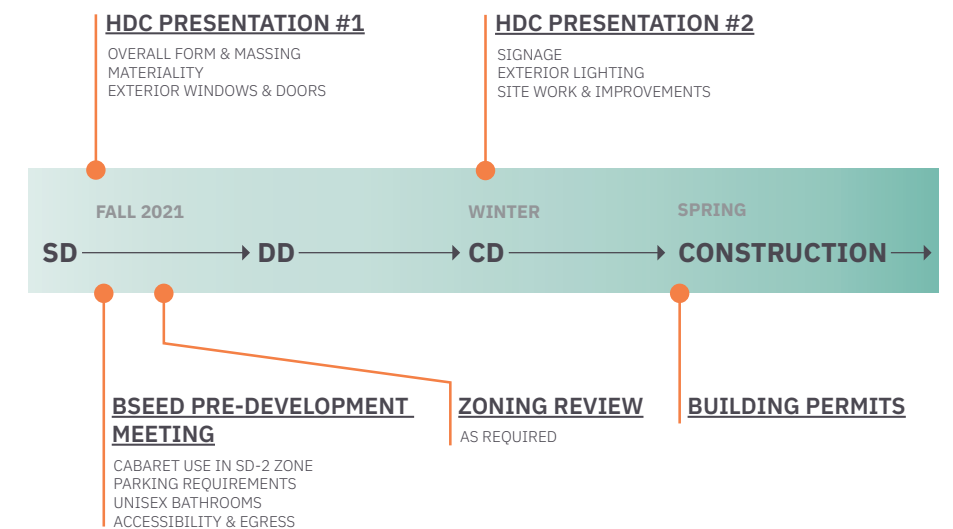

Why Stanley's?

The history of Stanley Hong's Mannia Cafe piqued our interest on many levels, from the striking design by a courageous black architect to the restaurant's history of being a well-known hospitality establishment, created by an immigrant family. To this day, Stanley's holds a treasured place in the memories of the community. The architect Nathan Johnson and the Hong Family all shared a vision that became a memorable and a cherished part of Detroit's history. It is often the role of arts presenters to honor society's boldest individuals. Our goal is to carry on with the narrative of this building, turning a page and starting a whole new chapter, bringing Stanley's back to life.

The history of the creation of this building, a pursuit by the Hong family entrusting Nathan Johnson to design their new restaurant, is a vignette that displays the tenacity

of individual entrepreneurs which gives our Detroit community strength of character. Additionally, the building holds a place in the history of Detroit hip hop as well. During the 90's, the restaurant hosted a regular event called "Rhythm Kitchen" which is known as the epicenter of that hip hop era, giving one of the first platforms to Eminem.

By restoring this unique building and creating a performing arts venue and hospitality space, we intend to honor the spirit of the buildings first owners and designer and the buildings legacy position in the arts community. As a performing arts venue, we will provide a world-class space for artists to present their work and engage with their audiences. By housing the arts in a space that has a vibrant past marked by individuality we can create an energy that both artists and our immediate community can embrace as a dynamic experience.

Our commitment to restoring this historic building mirrors our already established role in the arts. Our responsibility as presenters is to support artists in a multitude of ways. Not only do we create the immediate financial opportunity of showcasing their work, but we also build awareness for artists in the international community so they can grow and thrive. As a company we have a profound passion for the pursuit and rehabilitation of this building to honor it appropriately.

- Jen Lyon, Owner



1971

Source - 2



1971

Source - 3

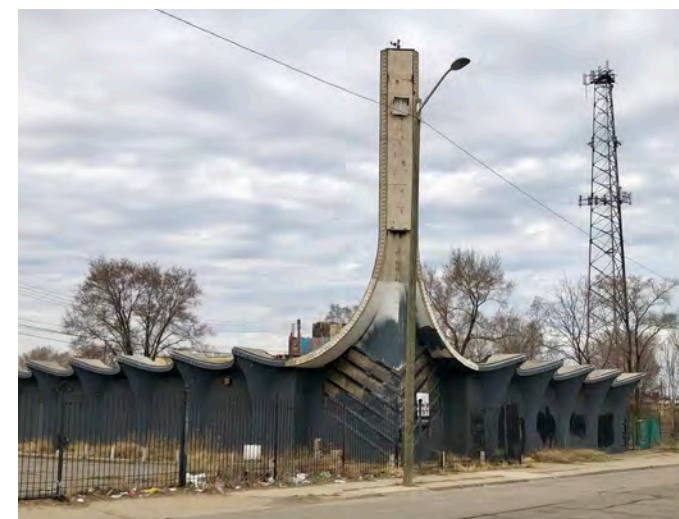

2021

Source - 33



2022

Proposed







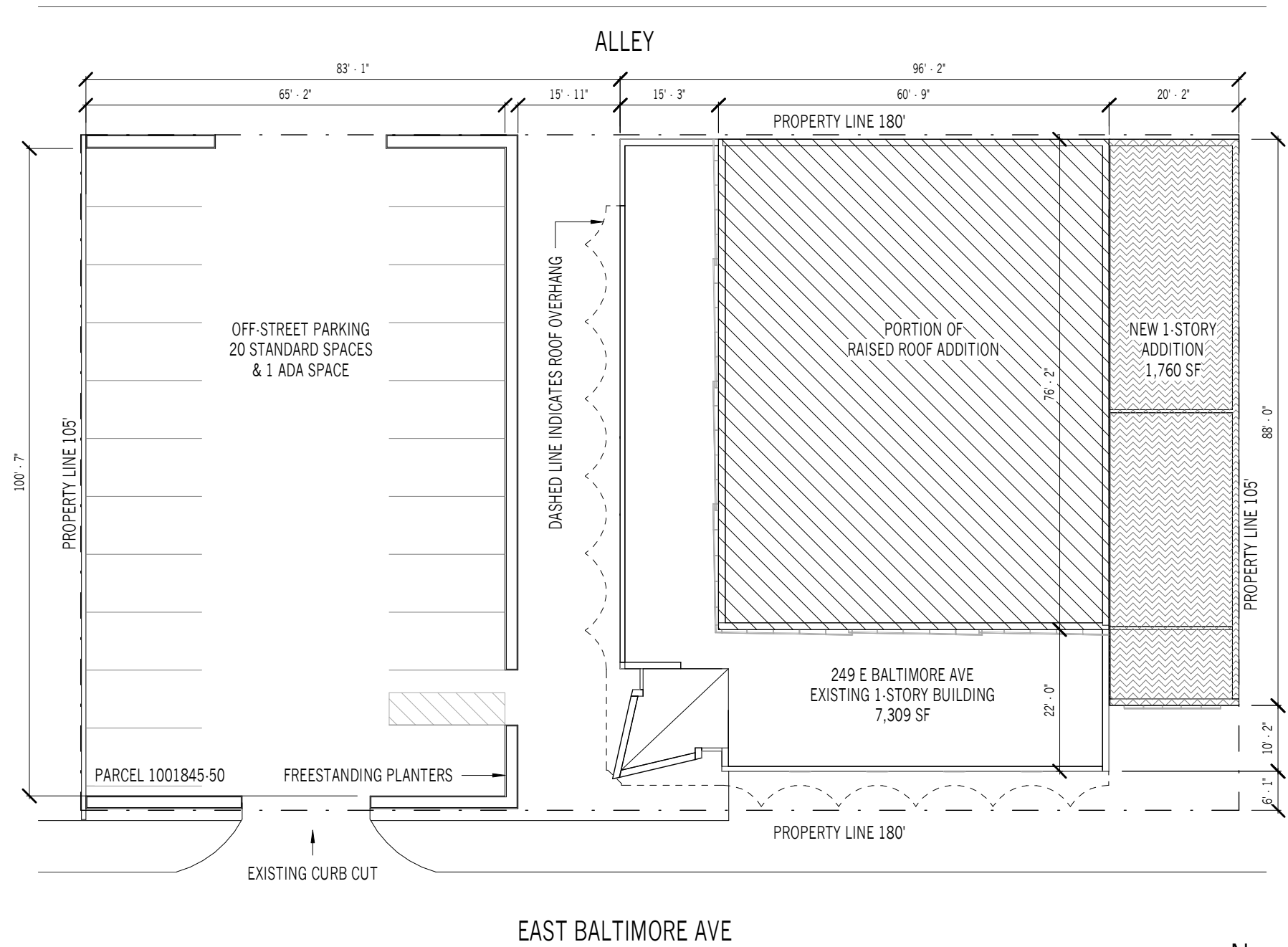

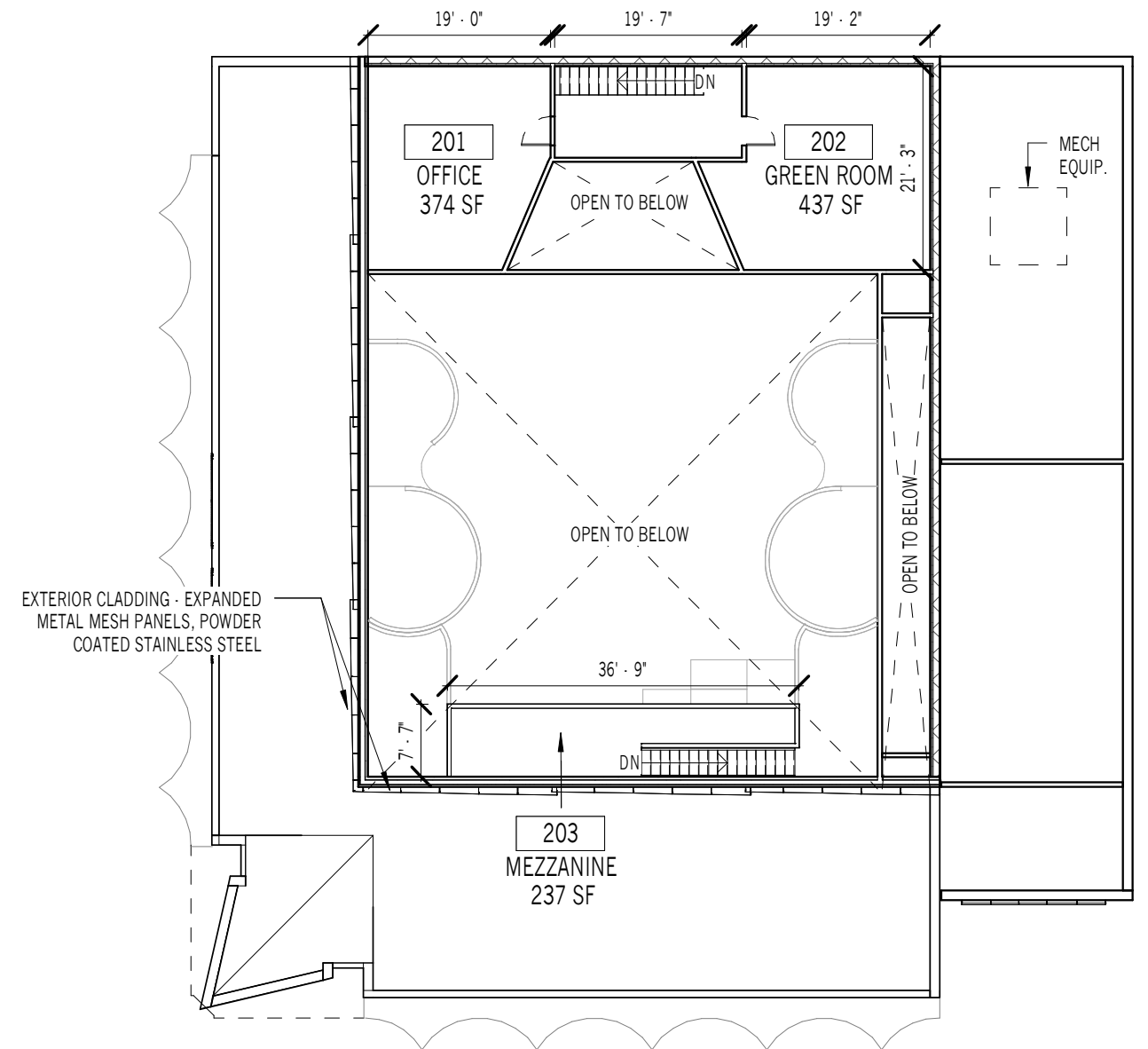
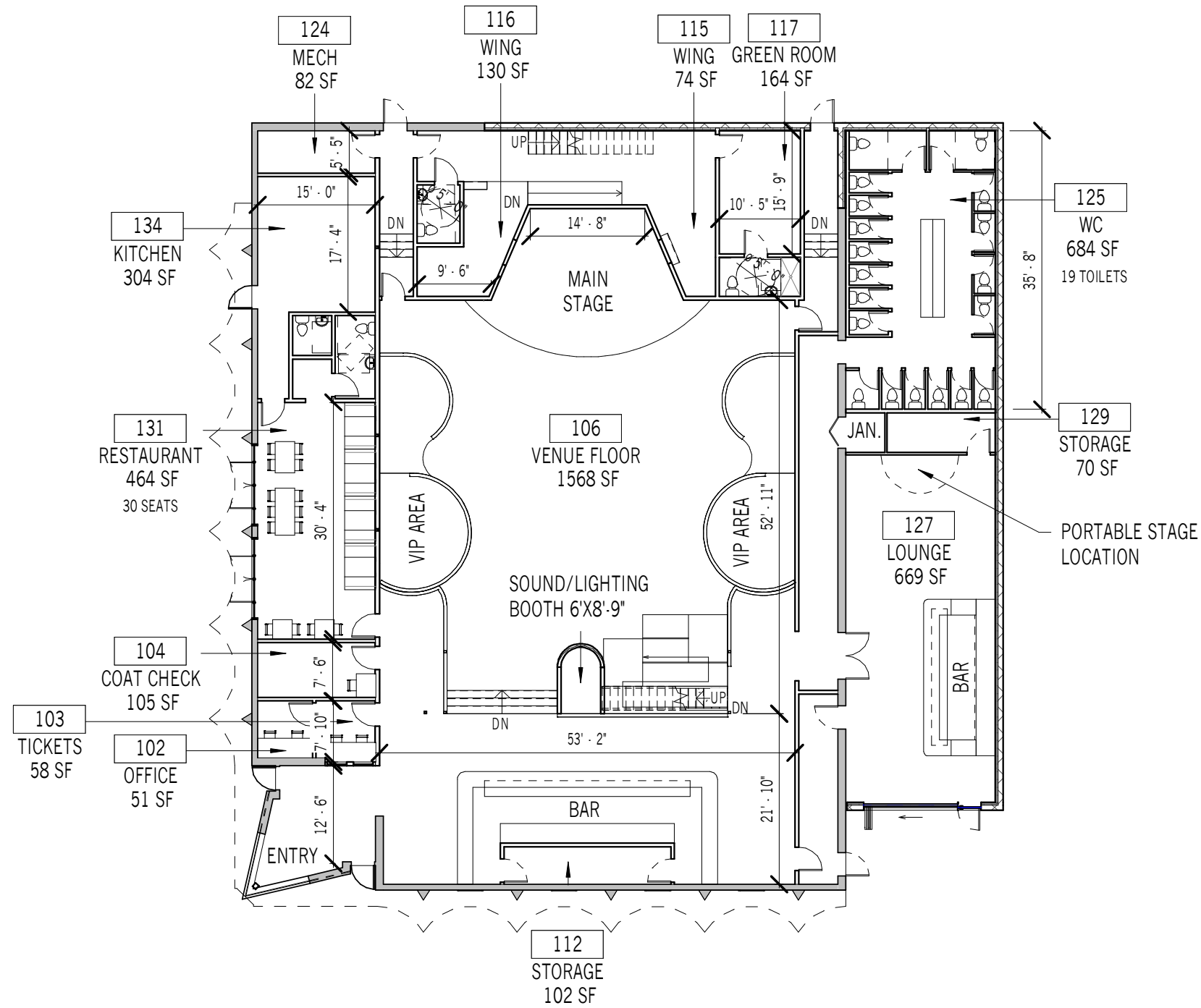

VENUE 7449 SF / 789 OCC.

RESTAURANT 875 SF / 33 OCC.

LOUNGE 1,069 SF / 135 OCC.

TOTAL 9,393 SF / 954 OCC.



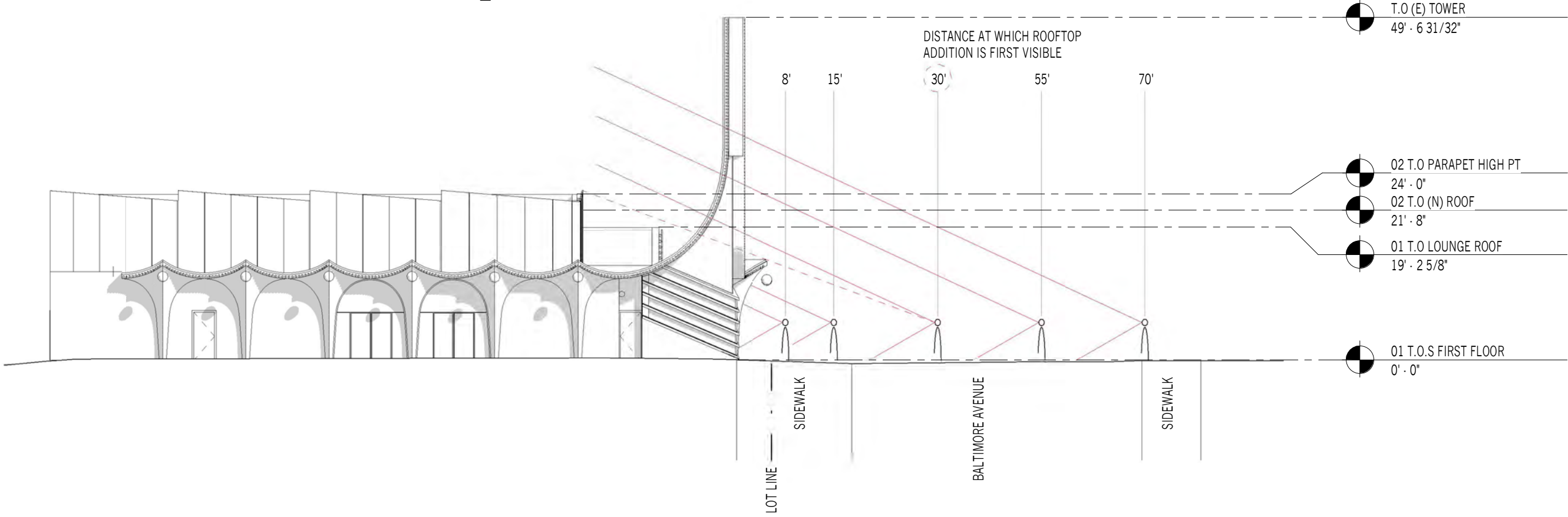
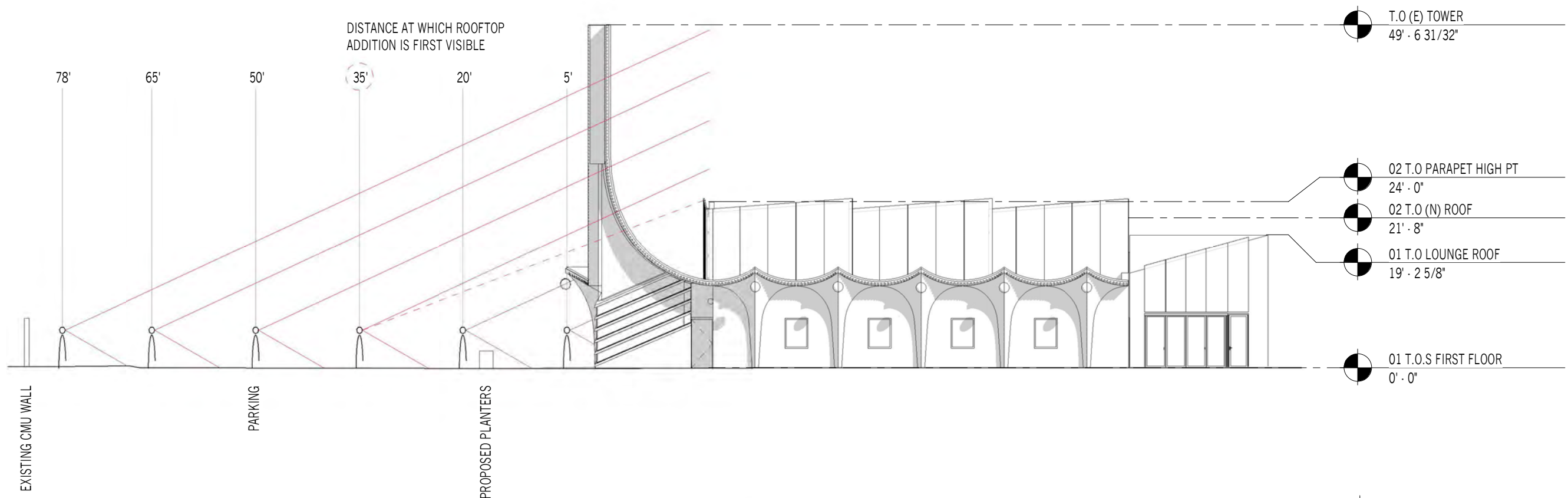

VIEW KEY

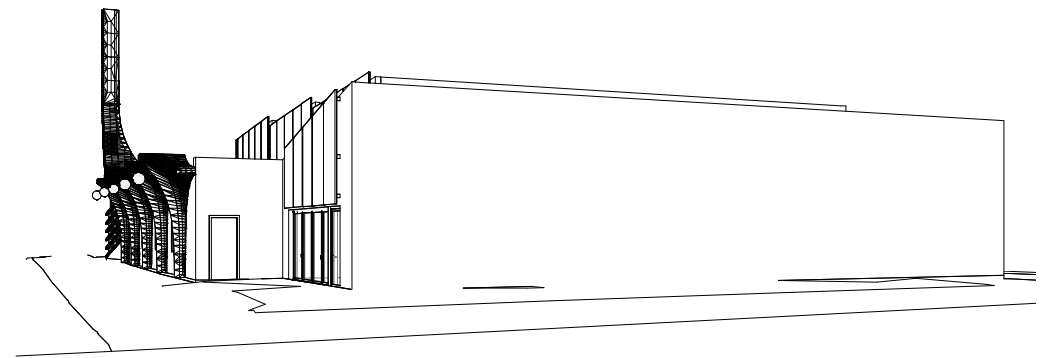
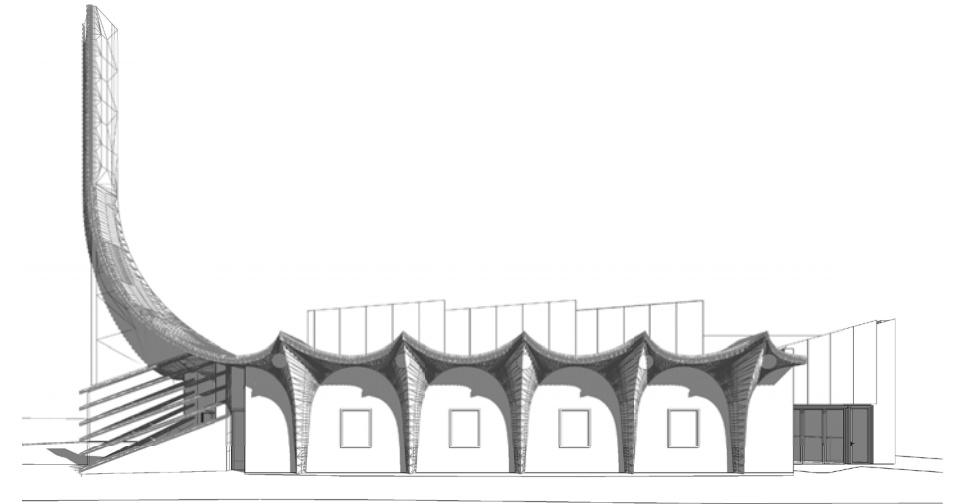
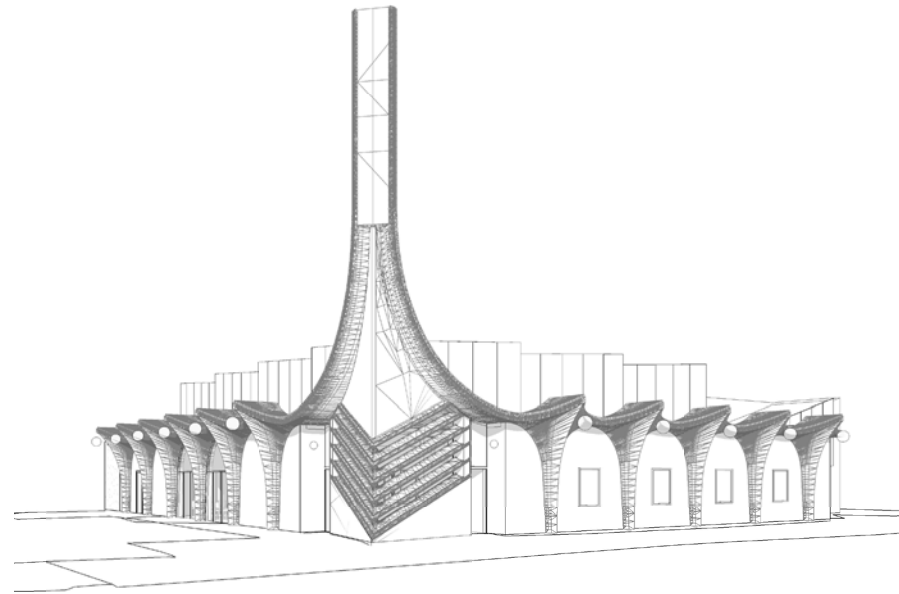
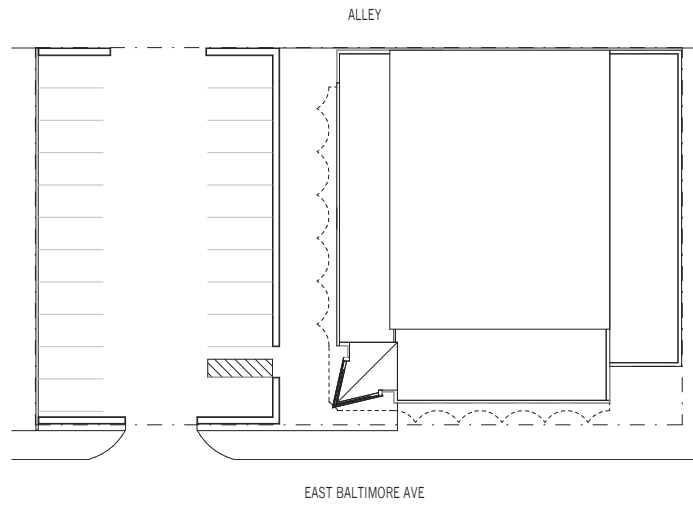

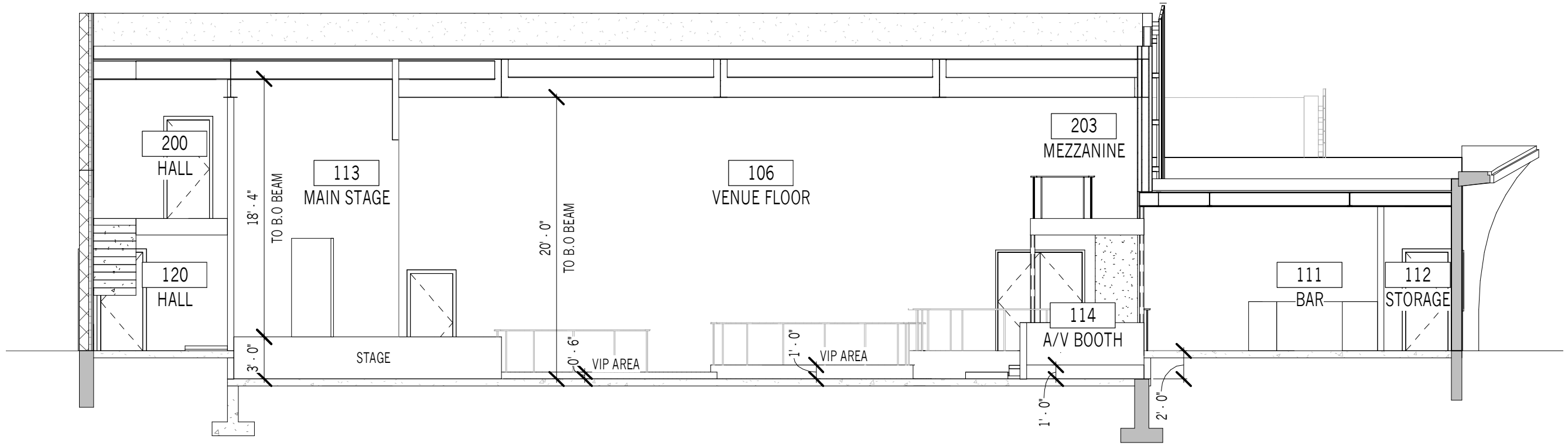
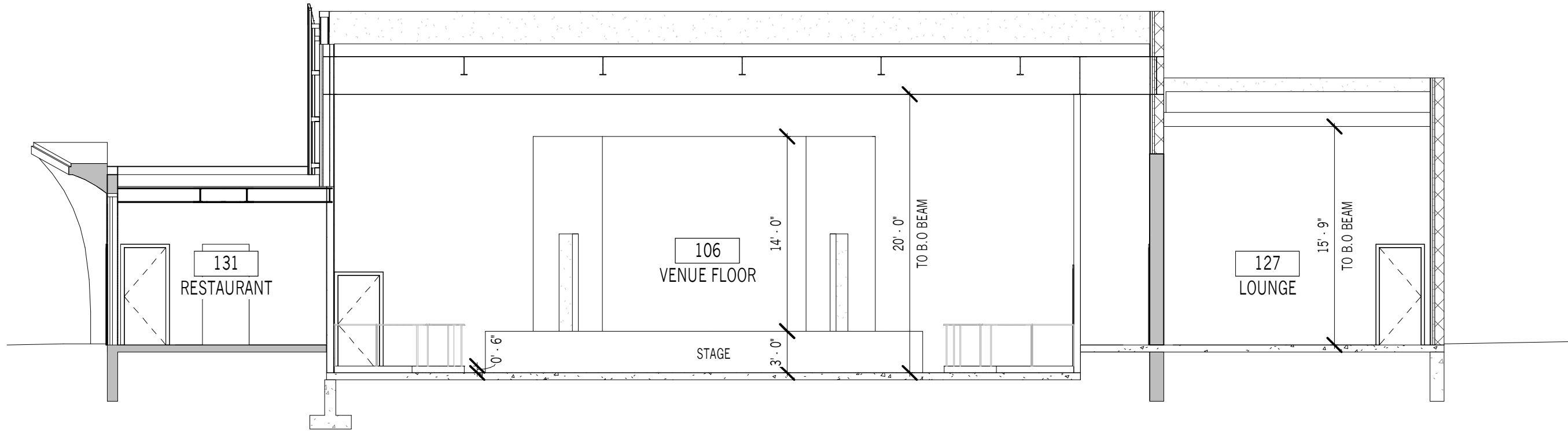

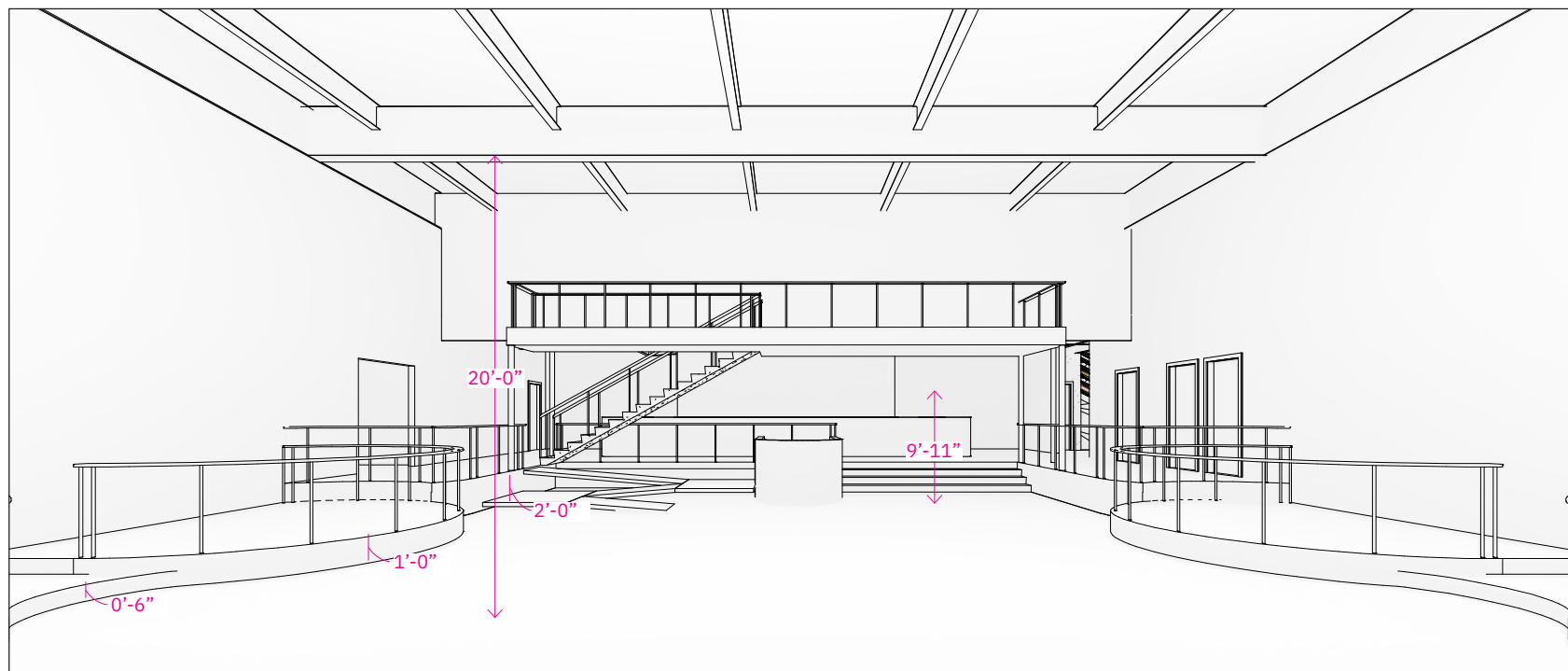

View of Venue Floor from Stage

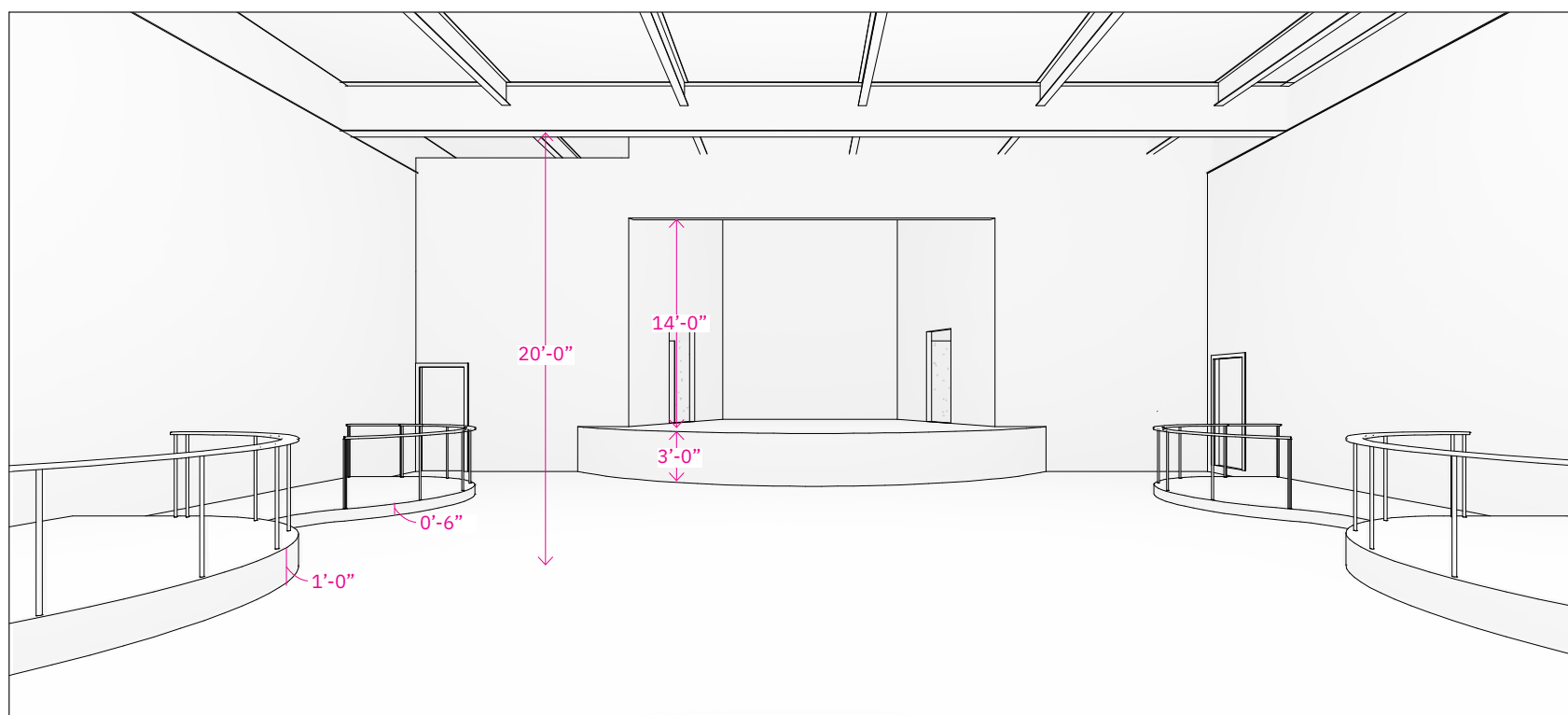

View of Stage from Venue Floor

STAGE HEIGHT

**2'-6" MIN.
3'-0"+ IDEAL**

Williamsburg Music Hall (NYC)	2'-6"
Paper Tiger (NYC)	2'-11"
National Sawdust (NYC)	2'-6"
The Dance (NYC)	4'-0"
Irving Plaza (NYC)	3'-3"
Mercury Lounge (NYC)	2'-6"
The Crocodile (STL)	3'-5"
Belly Up (SD, CA)	2'-8"

CEILING HEIGHT

**14'-0" MIN. FROM
STAGE TO LIGHTS
HIGHER IS BETTER**

Williamsburg Music Hall (NYC)	18'-0" ceiling
	14'-0" to lighting grid
Lincoln Hall (CHI)	14'-0" to lighting grid
Neumos (STL)	16'-0" ceiling
	11'-0" to lighting grid
National Sawdust (NYC)	25'-0" ceiling
Irving Plaza (NYC)	19'-0" to lighting grid
The Crocodile (STL)	15'-0" ceiling
The Roxy (LA)	25'-0" ceiling



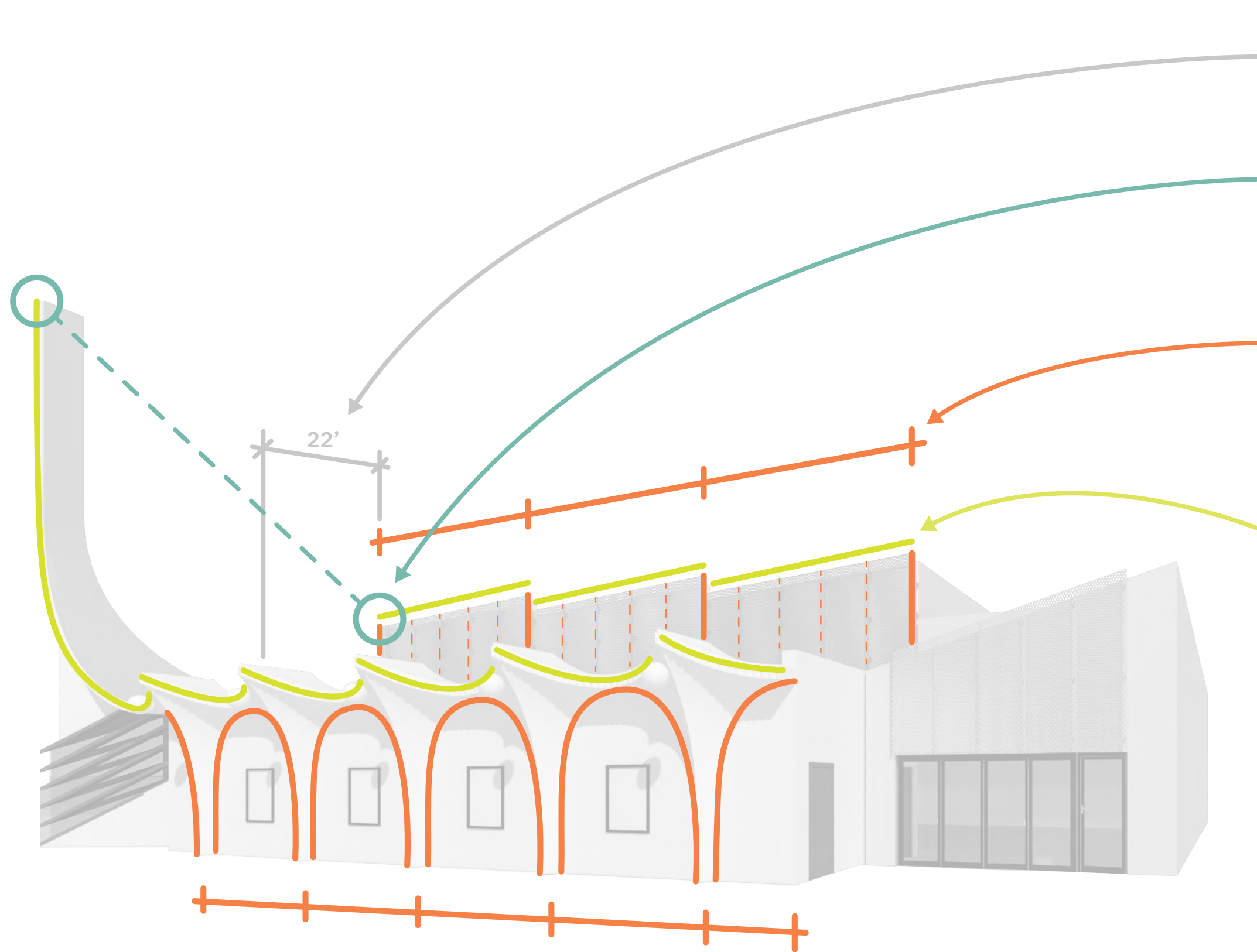

#1: HEIGHT
 THE ROOFTOP ADDITION SETS BACK 22' FROM THE FRONT + 15' FROM THE WEST TO MINIMIZE ITS PRESENCE FROM THE STREET LEVEL

#20: ORIENTATION
 ADDITION HEIGHT CLOSEST TO THE EXISTING TOWER IS LOWEST TO REINFORCE PROMINENCE OF TOWER

#16 DIRECTIONAL EXPRESSION OF FACADE
#2 PROPORTION OF FACADE
 THE ROOFTOP ADDITION IS SIGNIFICANTLY WIDER THAN TALL. THE FEATHERED PANELS BREAK UP THE MASS SIMILAR TO THE ARCHES BELOW. THE BAY SIZE IS SHIFTED TO A LARGER, SIMPLER ARRANGEMENT IN DEFERENCE TO THE EXISTING

#19: DEGREE OF COMPLEXITY
#25: SYMMETRICAL APPEARANCE
 FEATHERED FACADE PANELS COMPLEMENT THE UNDULATING PANELS OF THE EXISTING, WHILE PRESENTING A SIMPLE LEVEL OF DETAIL. THE FEATHERS ARE MIRRORED ALONG THE BUILDING'S EXISTING LINE OF SYMMETRY



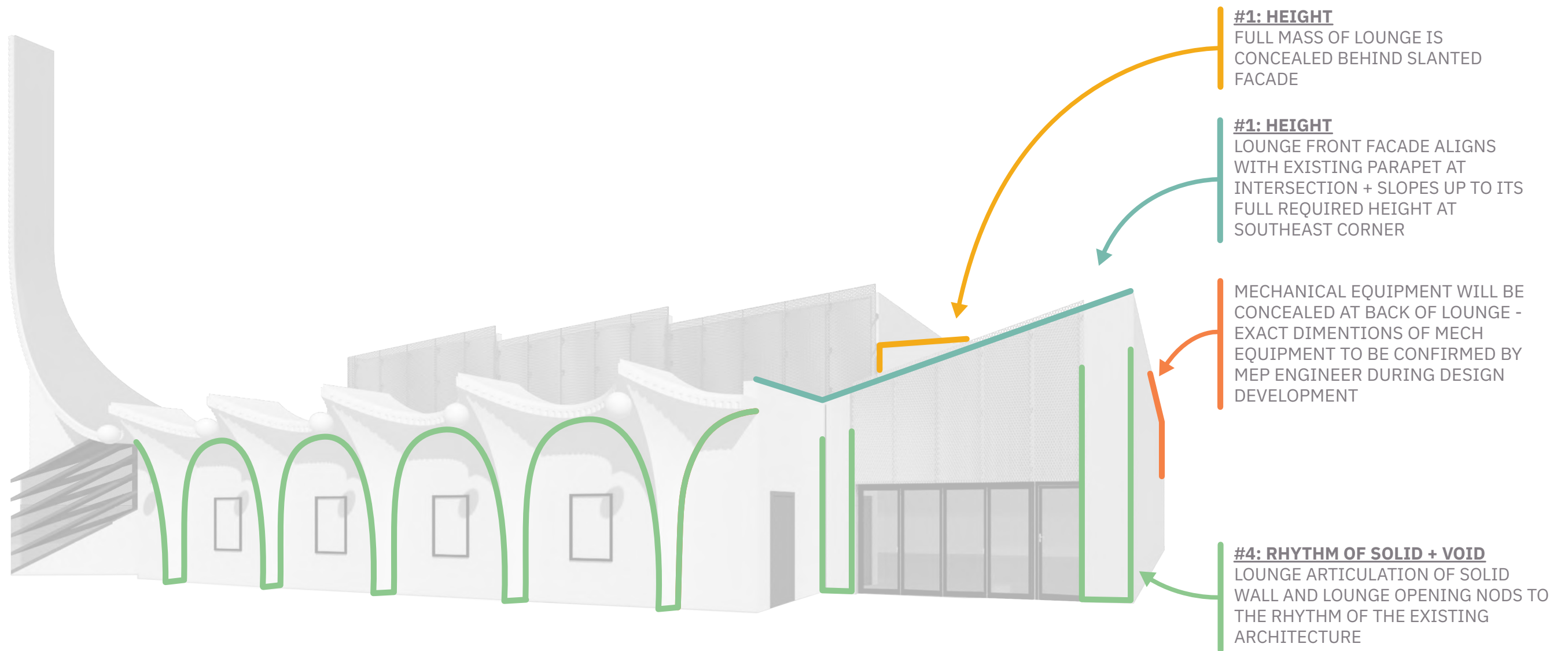

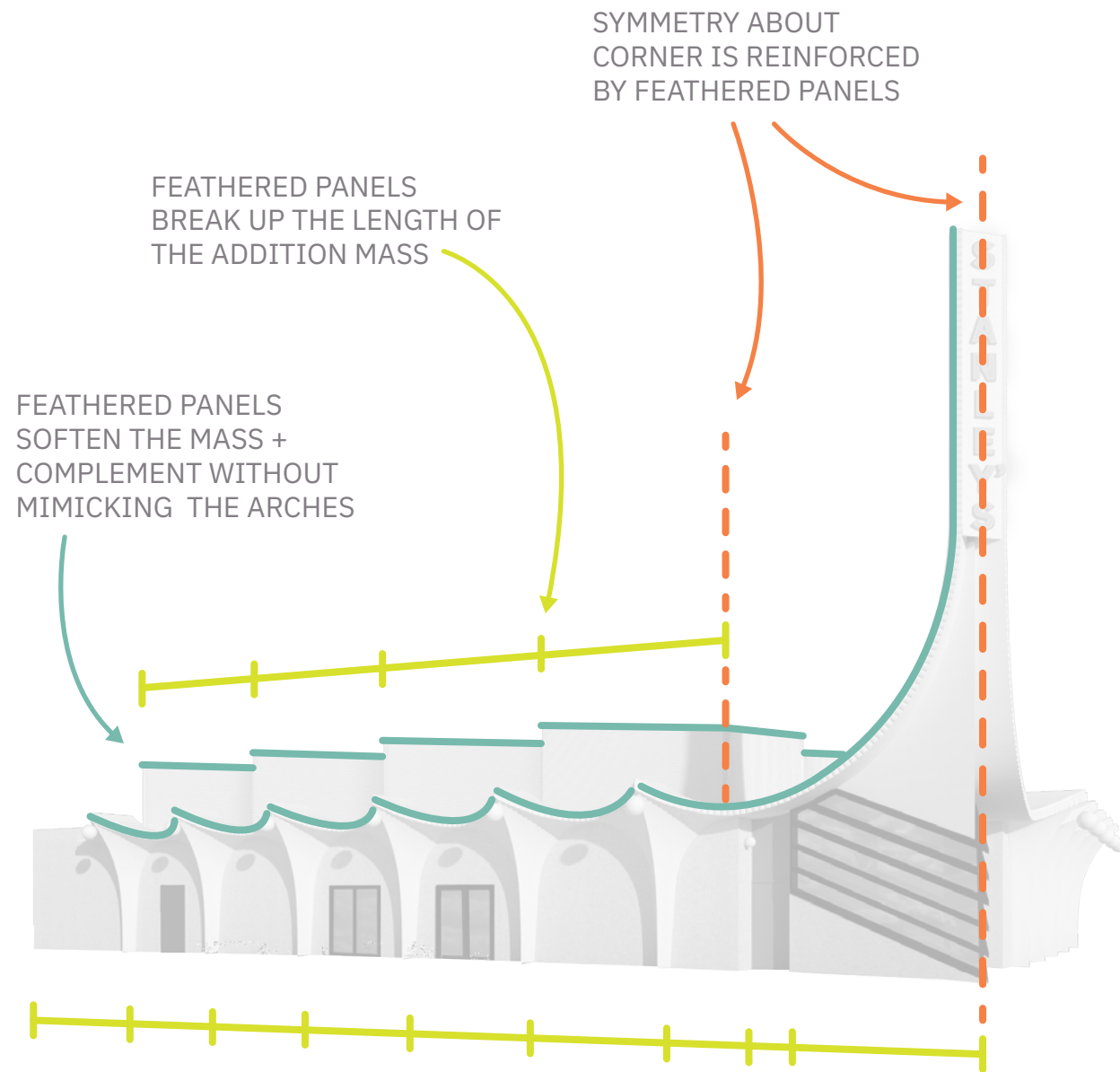

PROPOSAL - FEATHERED PARAPET

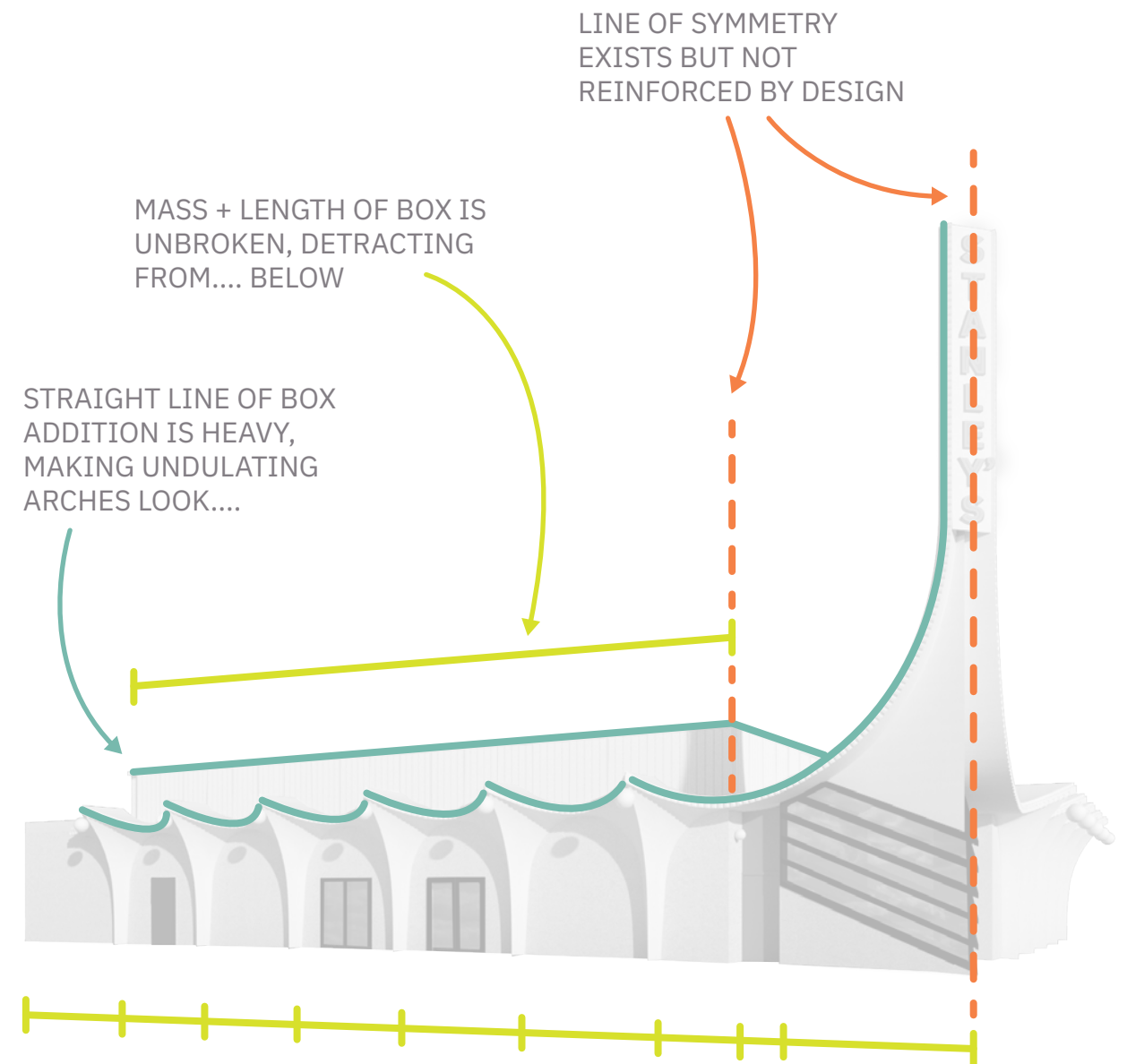

A SIMPLE BOX, DETRACTING FROM THE EXISTING



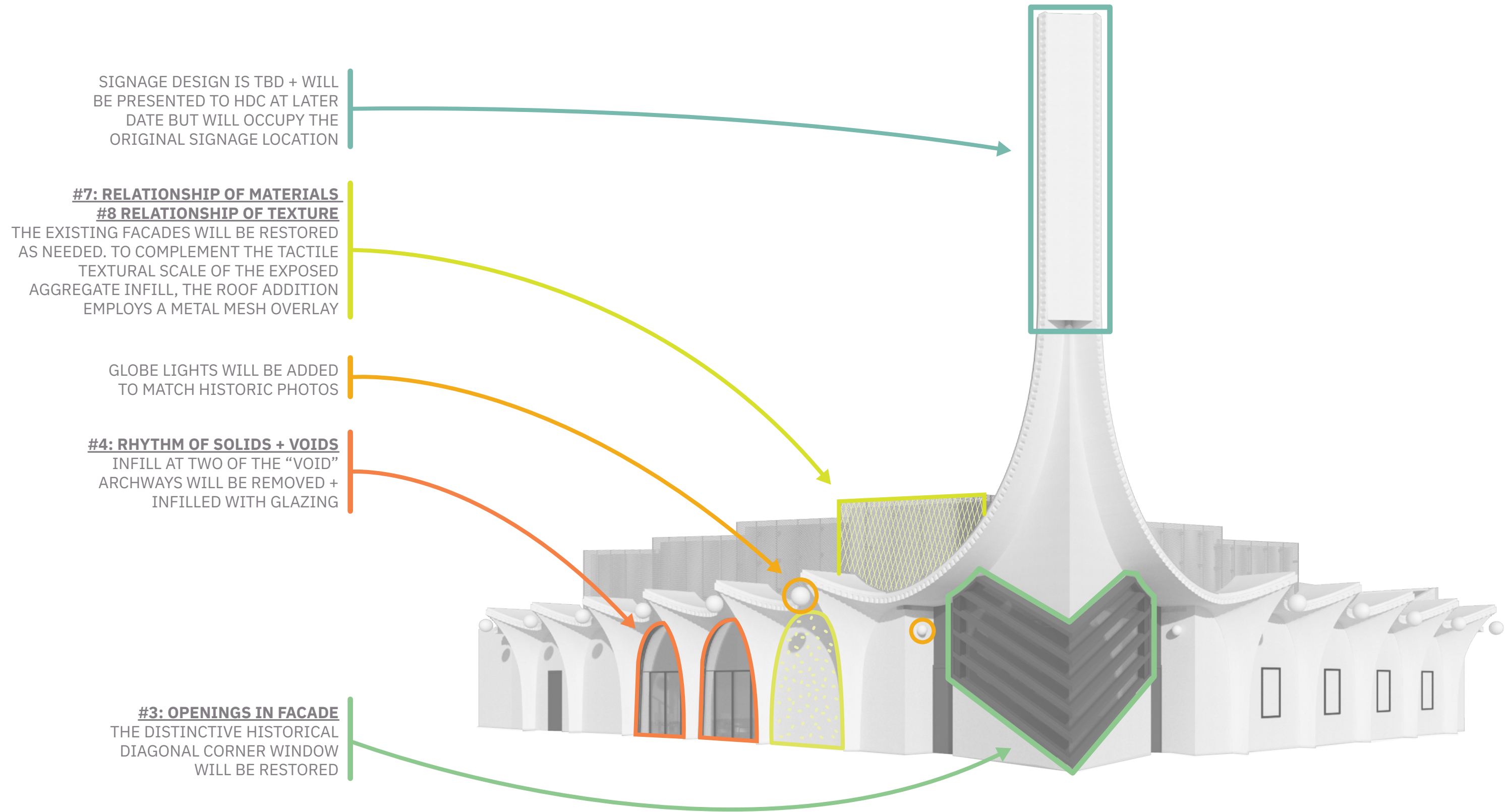

SIGNAGE DESIGN IS TBD + WILL BE PRESENTED TO HDC AT LATER DATE BUT WILL OCCUPY THE ORIGINAL SIGNAGE LOCATION

#7: RELATIONSHIP OF MATERIALS

#8 RELATIONSHIP OF TEXTURE

THE EXISTING FACADES WILL BE RESTORED AS NEEDED. TO COMPLEMENT THE TACTILE TEXTURAL SCALE OF THE EXPOSED AGGREGATE INFILL, THE ROOF ADDITION EMPLOYS A METAL MESH OVERLAY

GLOBE LIGHTS WILL BE ADDED TO MATCH HISTORIC PHOTOS

#4: RHYTHM OF SOLIDS + VOIDS

INFILL AT TWO OF THE "VOID" ARCHWAYS WILL BE REMOVED + INFILLED WITH GLAZING

#3: OPENINGS IN FACADE

THE DISTINCTIVE HISTORICAL DIAGONAL CORNER WINDOW WILL BE RESTORED



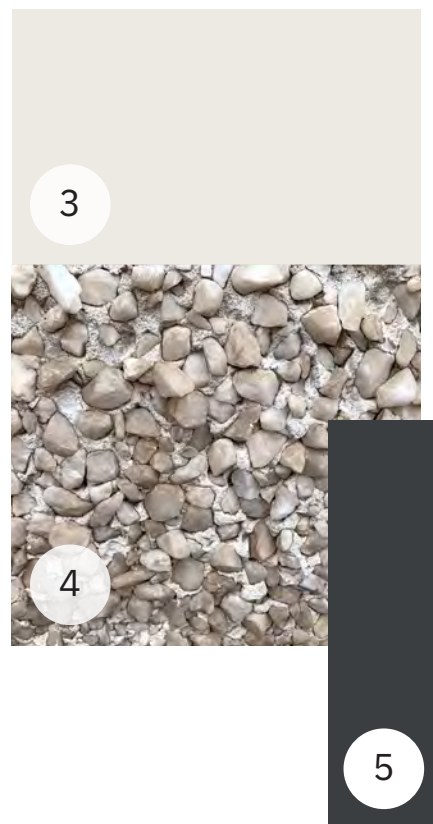
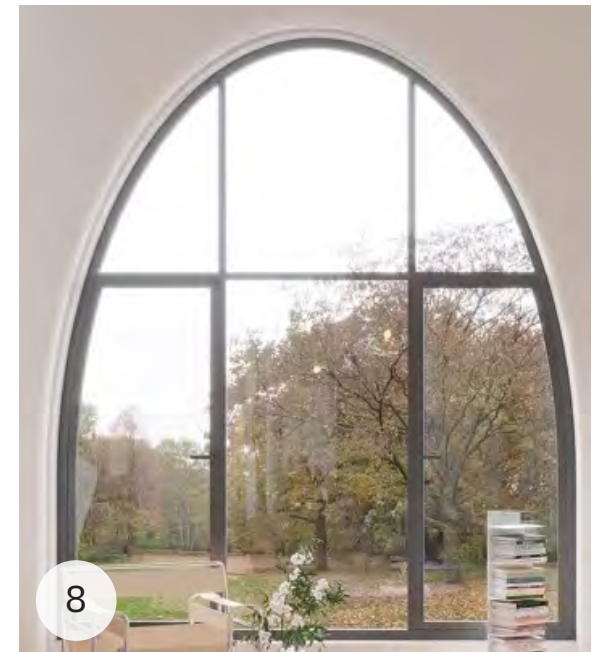
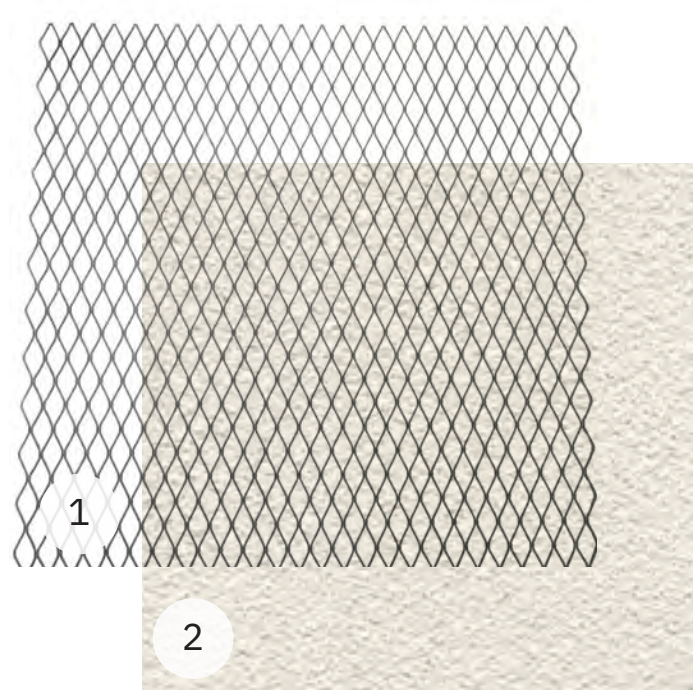
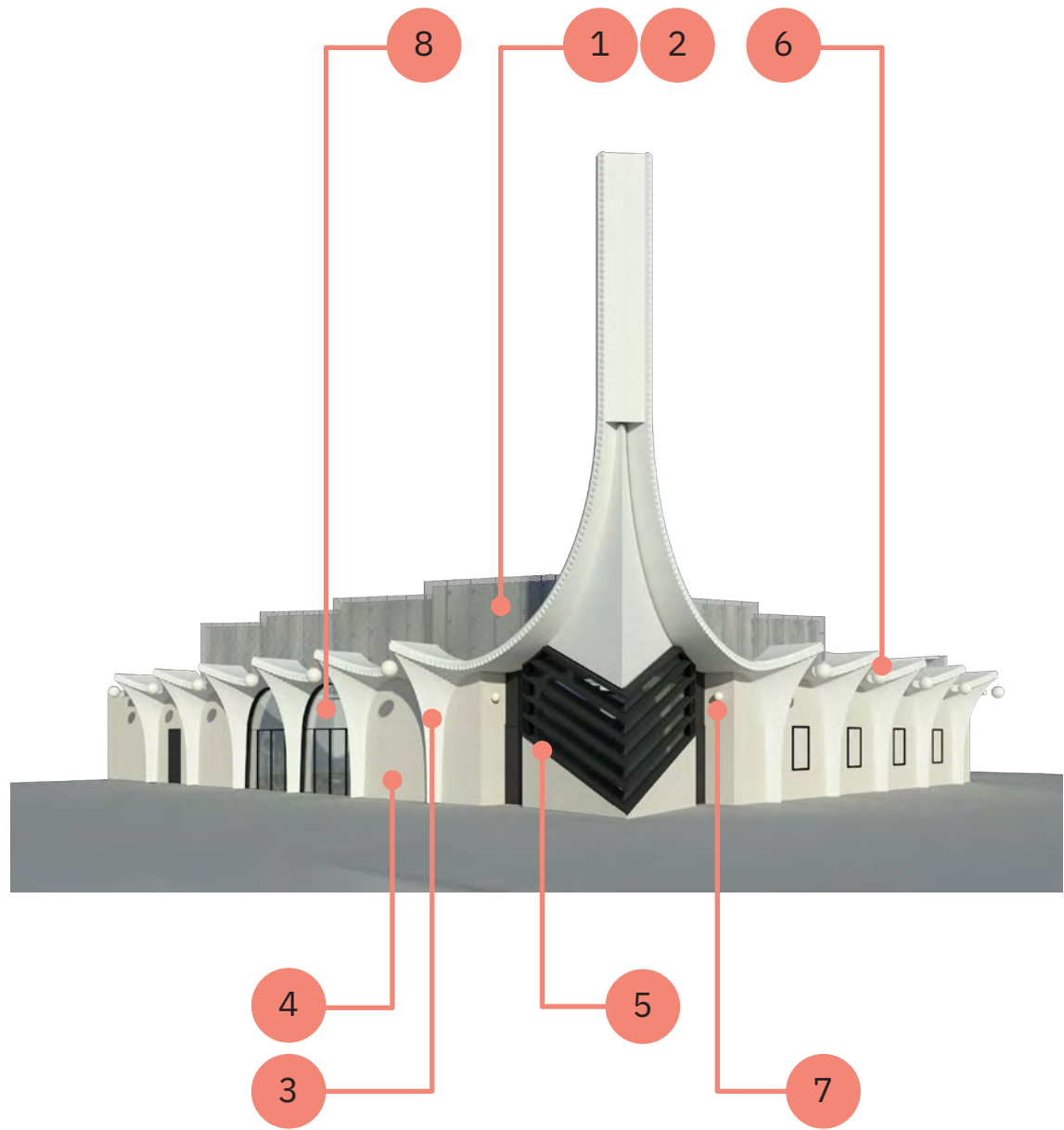

1. Stainless steel 304 expanded metal mesh - 3/4" mesh size - 13 gauge - dark grey architectural powdercoat finish
2. Fine-sand acrylic finish over EIFS to match Benjamin Moore OC-17 White Dove
3. Paint - Benjamin Moore OC-17 White Dove (color matched to original paint)
4. Existing exposed aggregate concrete
5. Window Trim + Side Door Paint - Benjamin Moore 2120-20 Black Iron
6. Troy RLM Globe Pendant - 12" ø - matte black - stem mount
7. Incon Lighting 388 Series Sconce - 8" ø - white globe - black base
8. Custom arched window with single glass door - see detail drawings - frame color to match Benjamin Moore 2120-20 Black Iron



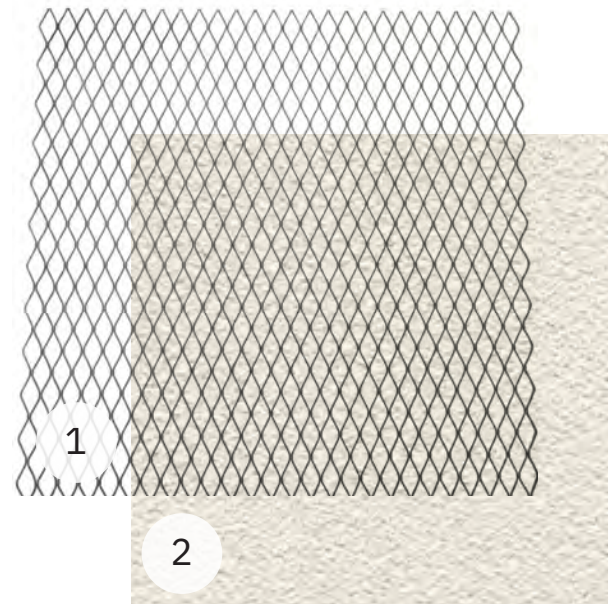
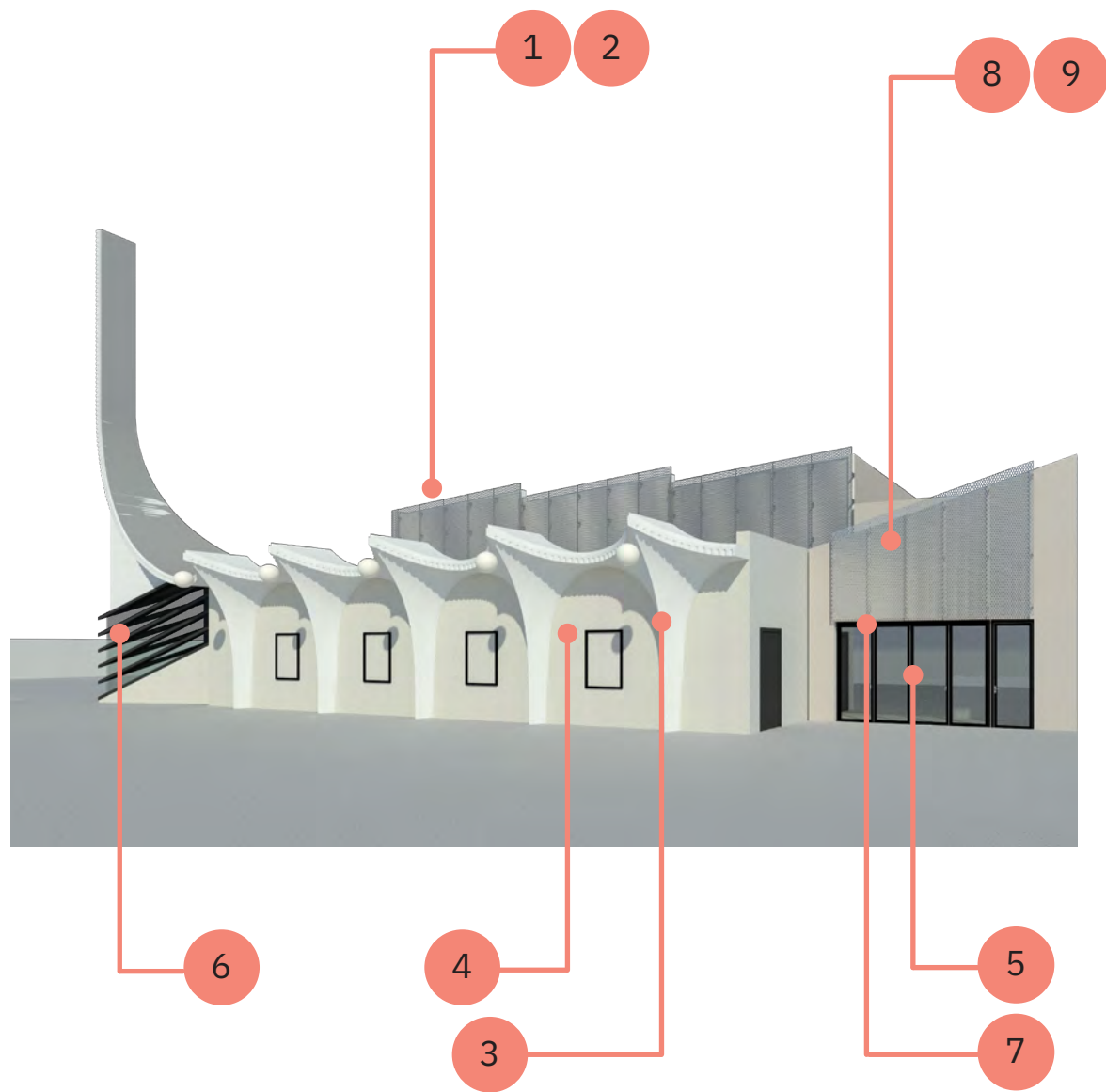

1. Stainless steel 304 flattened expanded metal mesh - 3/4" mesh size - 13 gauge - dark grey architectural powdercoat finish
2. Fine-sand acrylic finish over EIFS to match Benjamin Moore OC-46 Halo
3. Paint - Benjamin Moore OC-17 White Dove (color matched to original paint)
4. Existing exposed aggregate concrete
5. Nanawall folding glass wall w/ operable door - frame to match Benjamin Moore 2120-20 Black Iron
6. Window Trim + Side Door Paint - Benjamin Moore 2120-20 Black Iron
7. Paint - Benjamin Moore HC-95 Sag Harbor Gray
8. Stainless steel 304 flattened expanded metal mesh - 1.5" mesh size - clear finish
9. Fine-sand acrylic finish over EIFS to match Benjamin Moore OC-48 Hazy Skies



Roof Addition Mesh

Material: Stainless steel

Type: Flattened

Size: 3/4"

Strand width: 0.101"

Thickness: 0.076"

Open area: 79%

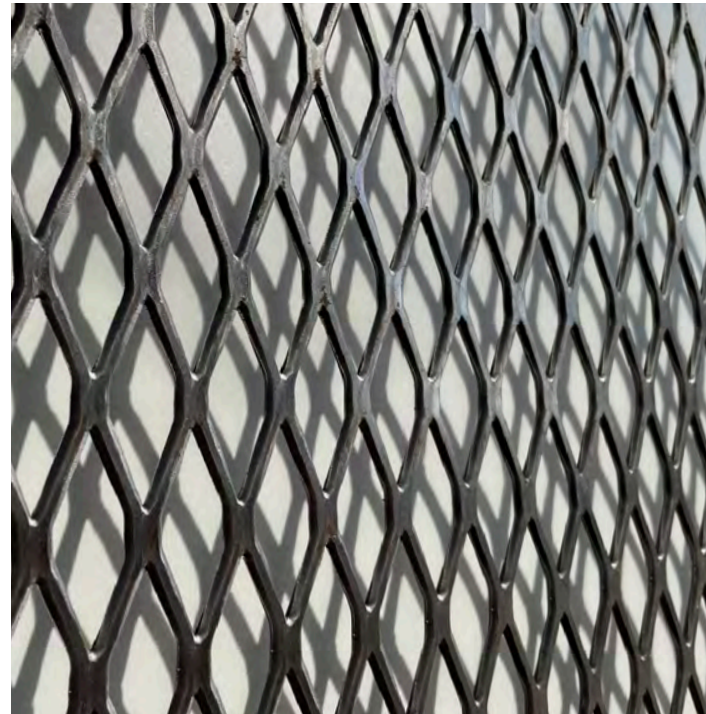

Full sun



Part sun



Shade

Lounge Facade Mesh

Material: Stainless steel

Type: Flattened

Size: 1-1/2"

Strand width: 0.114"

Thickness: 0.076"

Open area: 83%



Full sun



Part sun



Shade





APPENDIX A

Existing Conditions









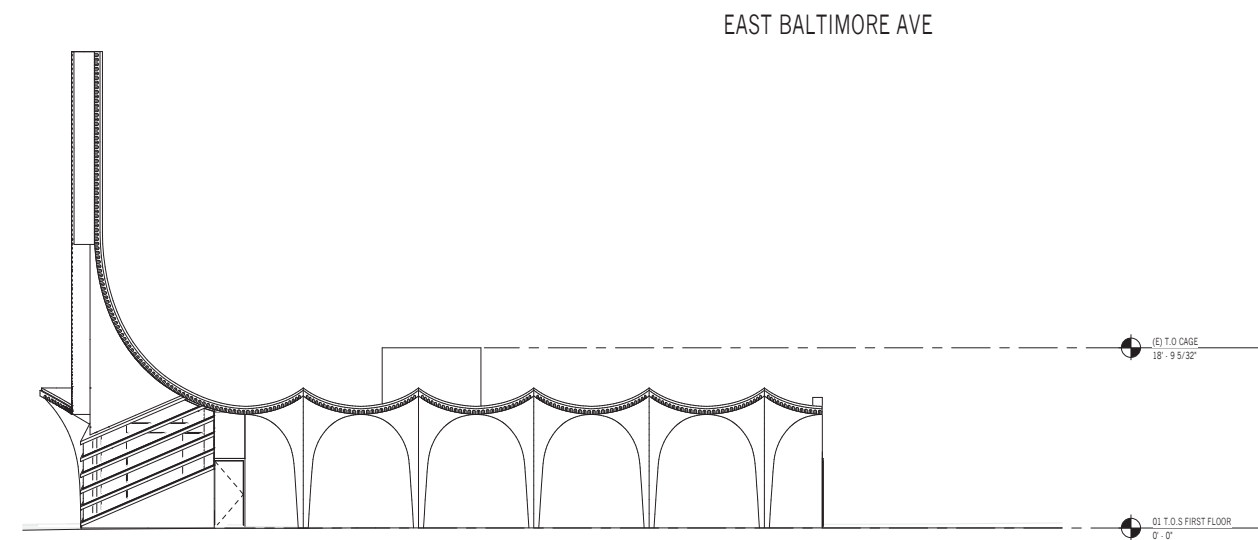
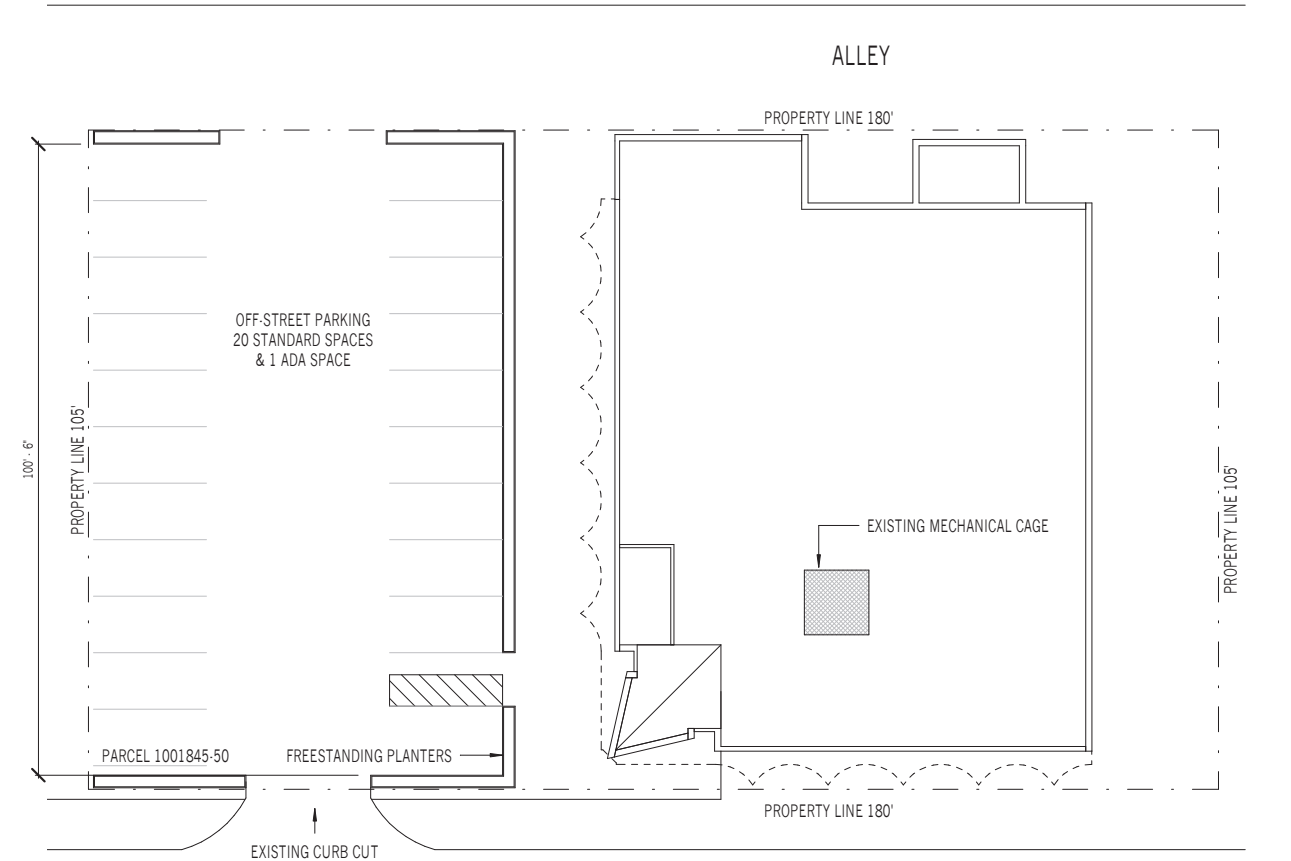



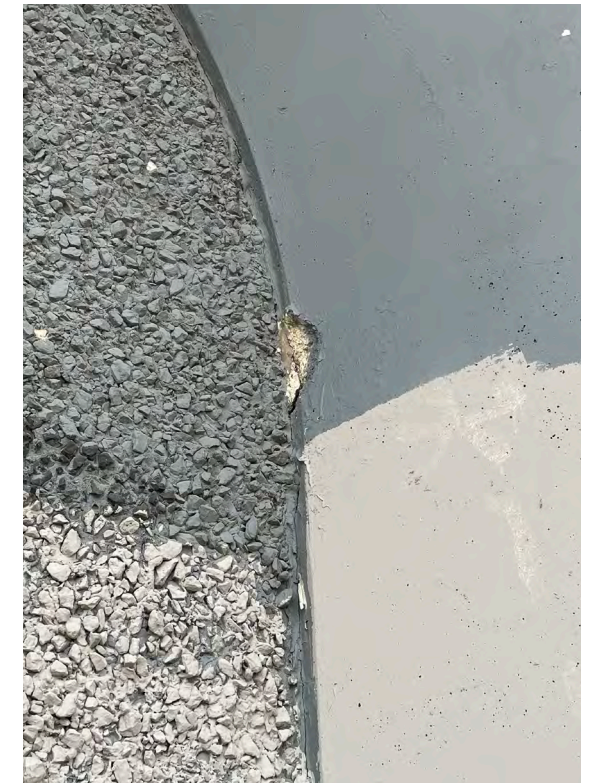





APPENDIX B

Historic District Commission

Elements of Design

(1) Height.

The single building Stanley Hong's Mannia Café Historic District is one story tall.

- The existing interior ceiling height is roughly 11'-3", not conducive to most contemporary commercial uses, and especially not to a performing arts venue
- The new design maintains the single story layout, while increasing the ceiling height and adding two interior mezzanines

(2) Proportion of building's front façade.

Stanley Hong's Mannia Café has two primary façades - the south and west, which meet at the southwest corner entry bay. Both are significantly wider than tall. The East Baltimore Avenue (south) façade is composed of five full bays with half-bays at its outer ends, and the west façade is composed of six bays, also with half-bays at its outer ends. The corner entry, composed of an identical east and west face, is taller than wide, including the tower.

- The existing facade is maintained and will be restored as required
- The rooftop addition is also significantly wider than tall. It shifts the scale of the existing arch bays, increasing the width to create "feathered" panels in three bays along the south facade and four along the west facade. The increased width differentiates the two rhythms and is deferential to the historic facade, but similarly breaks up the horizontality of the mass.
- The east addition is wider than tall and is taller overall than the existing structure, but the height of the front facade matches the existing parapet where they adjoin and slopes up from that point.

(3) Proportion of openings within the façades.

The primary façades are windowless, except for the five diagonally arranged horizontal glass panels, which are now boarded, on each face of the southwest corner entry bay. At each outer end of the entry bay is a single doorway. There is also a single door opening within the rear (north) arch of the west façade.

- The distinctive corner window and entrances will be maintained and restored.
- At the west facade, facing the parking lot, the infill will be removed in the second and third full bays to create doors and windows provide access and natural light for the new restaurant. The full parabolic arch will be infilled with new glazing, with swinging doors integrated into the opening.
- The utility doorway at the former takeout area will be maintained as kitchen access.

(4) Rhythm of solids to voids in the front façade.

A strong, regular rhythm of solids to voids exists on both primary façades due to the arcading created by the protruding parabolic arches and the solid surface appearing to recede between them. The two main entrances are tucked into the outer edges of each face of the corner tower entry section and, therefore, they do not stand out.

- New doors will be added only on the west facade facing the parking lot, as required for the new program
- The lounge addition brings an articulation of "solid and void" through the plain sections of facade at each side and the central storefront with screen above

(7) Relationship of materials.

The primary façades are composed of particle board, sheet metal, thin cast concrete, and glass (now covered) between strips of steel, while exposed concrete block is the only material on the unadorned rear (north) and east elevations.

- The existing facade is maintained and will be restored as required
- The new additions will be composed of different material, with a flat synthetic stucco coat and metal mesh panel overlays. The east and north facades will be painted concrete block, similar to the existing utilitarian east and north facades.



(8) Relationship of textures.

The major textures are the result of repetitive elements, such as the smooth cast concrete parabolic arches, scalloped edges, and the diagonal strips on either side of the entrances. The rough texture of coarse aggregate within the arches contrasts with smooth surfaces.

- The existing facade is maintained and will be restored as required
- The new additions employ a less detailed architecture than the existing, but insert elements of textural interest through metal mesh screen panels on the facades

(9) Relationship of colors.

Facades that were formerly cream color and white are almost completely covered by dark gray paint.

- The south and west primary facades will be cleaned and returned to their original coloration, and the entry doors will be repainted in their original red color.
- The exposed concrete block on the east and north facades will be painted to match
- The new rooftop addition and east elevation will be painted in similar tones to the existing, with slight variation as appropriate to differentiate the old from the new

(10) Relationship of architectural details.

The Googie-style, modernistic building features downward-facing parabolas creating rows of arches resulting in wave-like roof ends along East Baltimore Avenue (south) and the parking lot on the west. Lights were originally hung from the peak ends. The peaks of the half-arches meet at the corner entrance and rise into a tall, narrow concrete tower, originally displaying the name of the restaurant. The inverted parabolas are smooth cast concrete; within the arches are approximately 12 foot precast panels of concrete and coarse aggregate mixture. Five diagonal glass strips extend from near the front entrances and join at the central rise of the tower. The glass panels are currently boarded but still intact and framed in black steel. The entry doors are approximately 36 inches in width, framed out by black structural steel members that help support the entry tower.

- The existing facades are maintained with their distinctive Googie-style form and features
- The new additions do not mimic the Googie style, but draw inspiration from the rhythm, directionality, sense of motion, and organic formal motifs.
- The rooftop addition consists of a series of “feathered” panels with sloping parapet heights clad with mesh screen to add textural interest. The feathers slope up and out away from the existing tower, emphasizing the tower’s centrality. The addition sets back 15’ from the west facade and 20’ from the south facade.
- The east addition employs one strong geometric move with the diagonal cut of the front facade. The diagonal springs up from the existing parapet, showing continuation and deference to the existing scale, while rising up to the height required for the new program

(11) Relationship of roof shapes.

The flat roof cannot be seen from street level, although the raised roofing over the inverted parabolic arches is visible. The roof system is composed of steel I-beams and girders that supported corrugated metal decking and an insulation layer, which was then finished with roll out rubber and tar. The roofing material wraps up to cover the backside of the parapet, rising 25 inches above the roof line, on the north and the east sides of the building; on the embellished south and the west sides, the roofing material slopes up to meet and partially cover the backside of the inverted concrete parabolas, the peaks of which rise approximately 18 inches above the roof line.

- Both the new rooftop addition and east addition employ flat roofs, with all roofing hidden from the street in a similar fashion to the existing



(13) Relationship of significant landscape features and surface treatments.

The ground treatment abutting the south (East Baltimore Avenue), east and west sides of the building is composed of large poured concrete sidewalk paving. An area of concrete squares along the East Baltimore Avenue façade to the east of the entrance is cut out for plantings, now overgrown. Further west of the building is a large paved parking lot, originally with a pagoda-topped arch entrance off of East Baltimore Avenue, no longer extant. The alley behind the building is loose gravel.

- The concrete sidewalks at south and west facades will be restored, as will the portion of concrete sidewalk in front of the new east addition
- The recessed planter areas may be reactivated. Full design for the site strategies will be revised in a second Historic District Commission presentation.

(14) Relationship of open space to structure.

Open space includes the concrete paved areas and large parking lot on the west, which is contained on its west side by a tall concrete block wall, and on the East Baltimore Avenue frontage a decorative metal fence, which extends along the front entrance of the building. The rear of the property along the alley and east side are fenced with chain link and razor wire.

- The existing building and west parking lot are maintained
- The east addition fills in a currently unused 20' wide portion of the existing lot. The addition is set back 10' from the existing southeast facade corner to maintain the existing building as primary. This front area will be used for outdoor seating at the entrance of the addition

(15) Scale of façade and façade elements.

The primary façades of the building are moderate in scale, being only a single story, but defining most of its lot. Façade elements, such as the parabolic arches and corner tower, are comparatively large in scale. Details, such as the scallop-edged cornices, are small in scale.

- The existing facade is maintained and will be restored as required
- The rooftop addition shifts the scale of the existing arch bays, increasing the width to create three bays along the south facade and four along the west facade. The increased width differentiates the two rhythms and is deferential to the historic facade
- The rooftop addition materiality consists of powder coated metal mesh panels that float in front of a solid wall. The materiality is consistent, but plays with the scale of infill texture, in a nod to the existing. The level of detail at the rooftop is significantly less ornate, allowing the historic detailing to shine

(16) Directional expression of front façade.

The directional expression of the corner entry bay is emphatically vertical; the horizontal length of the south and west façades is tempered by the verticality of the legs of the arches dividing the bays.

- The existing facade is maintained and will be restored as required
- Similar to the existing building's strategy of tempering the horizontality with the arches, the rooftop addition employs a series of "feathered" panels with sloping parapet heights to break up the horizontality of the mass

(18) Relationship of lot coverage.

The building occupies approximately 75 to 80 % of its lot, excluding the parking lot.

- The east addition fills in a currently unused 20' wide portion of the existing lot. The addition is set back 10' from the existing southeast facade corner to maintain the existing building as primary. This front area will be used for outdoor seating at the entrance of the addition



(19) Degree of complexity within the façade.

The primary façades (south and west) are complex as they incorporate complex forms and nontraditional building materials to express ahistoricism and modernity.

(20) Orientation, vistas, overviews.

Located mid-block, the building's corner entry tower is oriented toward the southwest corner of its site, with entrances facing East Baltimore Avenue and the parking lot serving the building. The derelict building stands out from its immediate surroundings by its unique architectural style with swooping forms. Small industrial and residential buildings and vacant lots share the streetscape.

(21) Symmetric or asymmetric appearance.

The building is symmetrically arranged as it extends to the north and east from its corner tower entry bay.

(22) General environmental character.

The Stanley Hong's Mannia Café Historic District sits amongst vacant lots, and small-scale industrial and residential properties in the Milwaukee Junction Neighborhood, an area east of Woodward Avenue and the New Center Area located within proximity of a route of Detroit's Streetcar System, the QLINE. The building's historically industrial character, that of small to medium scale early 20 th Century industrial buildings and railroad tracks, is still apparent, although several buildings have been rehabilitated and repurposed. Stanley Hong's Mannia Café is an historic example of the mixed use character of a community that continues to grow.

- The existing façades are maintained and will be restored as required
- The new rooftop addition creates a similar, though less rhythm to complement the existing facade
- The south facade of the new east addition has a simpler form, the form defined by a diagonal slope from the existing building's parapet height up to the required interior height of the lounge. The mass of the building springs up to its full height a few feet back from the front facade. A single formal move of a sliding-folding storefront door system with a suspended metal mesh panel above breaks up the continuity of the front facade.

- The corner tower is maintained as the highest and most visible element of the design. The primary south and west façades are not obscured in any way. The building still maintains its unique presence amidst the surrounding industrial architecture, the uniqueness of which is augmented by the new additions.
- The east addition is set back 10' from the existing southeast facade corner to maintain the existing building as primary

- The existing symmetry of the primary façades is maintained
- The rooftop addition mirrors along the same line of symmetry, with the panels feathering out from the same central point behind the

- The historic Stanley Hong's Mannia Cafe sits in a relatively vacant industrial block. However the New Center Area and the more immediate Milwaukee Junction are currently experiencing a high level of redevelopment, both commercial and residential. From the new apartment building recently compete directly behind Stanley's, to the office tower renovation at Chroma, to the myriad restaurants, bars, and cafes that have opened in the past few years, the neighborhood's renaissance is in full swing. Stanley Hong's Mannia Cafe has sat empty since 2013. Though the structure is stunning, the space it provides is not conducive to many contemporary uses. The new east addition and rooftop addition proposed here will give the building a new life, activating it yet again as an important cultural asset to the surrounding neighborhood and the city of Detroit.





APPENDIX C

History of

Stanley Hong's Mannia Cafe

Stanley's Mannia Cafe

- Stanley Hong came to Detroit with his family from Guangdong, China in the 1930s. The Hong's achieved success in the restaurant business and Stanley operated 3 Chinese restaurants between 1940 and 2014.
- The Hong's were determined to reinvest in Detroit after the unrest of 1967.
- Family business – Brothers Stanley Hong, Oscar Hong, Peter Tong, and Henry Hong, and their children, all worked in the restaurant
- Stanley Hong entrusted the Architect, Nathan Johnson, with the design of his family home in 1962
- Stanley's opened on March 22, 1971
- Coleman Young, then Mayor of Detroit and a former classmate of Stanley's, was present at Opening Night and a frequent patron of the restaurant
- The restaurant was known for always welcoming African American as customers, at a time when not all businesses did so
- Stanley's employed as many as 80 people, Chinese cooks and African American waiters and waitresses
- The restaurant had many famous patrons and performers including The Temptations and Aretha Franklin



Postcard from 1970s

1

Source - *Historic Detroit - Stanley Hong's Man- nia Cafe*, 27

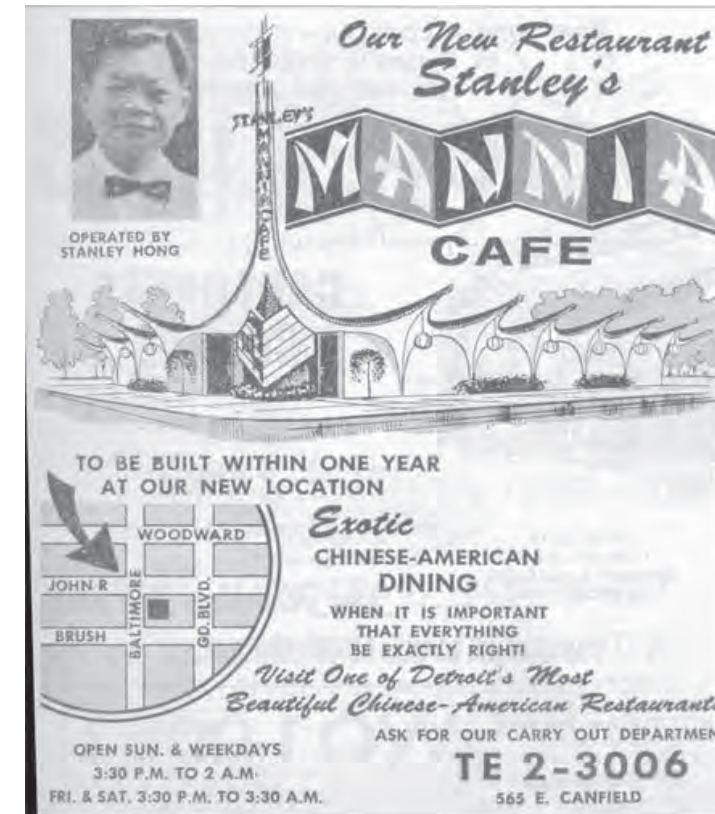

Flyer for Stanley's Mannia Cafe

2



Source unknown

<p>Congratulations from the following Contractors and Suppliers privileged to serve STANLEY'S MANNIA CAFE</p>			
<p>CADILLAC MEAT COMPANY 14446 Hamilton — Highland Park Phone 341-8900</p>		<p>A. J. MARSHALL COMPANY Kitchen Equipment and Supplies 4400 Cass at Canfield Phone TE 1-9450</p>	
<p>LAKESIDE FISHERIES Distributors of Fresh and Frozen Fish 1341 Adelalder Phone WO 5-2440</p>	<p>VICTOR VENTIMIGLIA FISH COMPANY, INC. Late and Green Fish Distributors 8933 Rarickval Phone 823-3011</p>	<p>WM. D. WHITE COMPANY Wholesale Meats 2504 Ferry Street Phone 823-1801</p>	<p>THE WHEEL COMPANY Wholesale Foods 4000 Ruckonah 823-7990</p>
<p>PELLERITO PRODUCE COMPANY 1171 Mayflower — Lincoln Park Phone BU 3-0163</p>	<p>EASTERN INSTITUTIONAL FOODS 308 E. Warren Phone 822-4800</p>	<p>I & G GROCER COMPANY 2001 Wilcox Phone 822-7500</p>	<p>ORIENTAL PROVISION COMPANY 12321 Western Village Phone TO 7-2854</p>
<p>KIN KING COMPANY Oriental Groceries 17415 Riggelle PO 8-3732</p>	<p>CAPITAL POULTRY 14446 Rucker Freeway Phone WO 1-5091</p>	<p>SHERILL ELECTRIC CO., INC. 1827 W. Eight Mile Phone DI 1-0417</p>	

Opening Night Newspaper Ad

2



“We didn’t copy anything there - we wanted to be original”

“You could see the tower from the Boulevard, and they’d come to Stanley’s.”

“We try to be honest. If we want to decorate a church, we let the structure do it instead of applying ornaments.”

- Nathan Johnson

Source - Detroit News, 12



Source - 2





Coleman Young



3 Restaurant Clients



3 Opening Day Festivities



Opening Day Crowd



3 Opening Day Festivities



3 Restaurant Staff

3



The Rhythm Kitchen

- In the early 1990s, Stanley's was the epicenter of the Detroit hip-hop scene
- One night a week, Stanley's was transformed into the Rhythm Kitchen, a music venue founded by clothing designer Maurice Malone in 1991
- Once a week, they cleared out all the tables, brought in heavy sound systems, and continued selling Chinese take-out and 40's of Colt45.
- Rhythm Kitchen featured reggae, jazz, and most notably rap battles
- It was the inspiration for The Chin Tiki hop-hop club in the movie 8 Mile.
- Maurice Malone – named “Steve Jobs of Denim” by Brooklyn Magazine. Today, he owns Williamsburg Garment Company
- Malone’s Hip Hop Shop, a clothing store on 7 Mile Road, was the place where many famous rappers and producers including Eminem, J-Dilla, D12, and Slum Village honed their skills

Source - *The Rhythm Kitchen Flyer, 4*
Denim's Master Designer, 28



J-Dilla, Proof, and friends outside the Hip Hop Shop 6



Sean "Puffy" Combs, Aaliya, and Biggie Smalls 6



Maurice Malone 31



The Rhythm Kitchen Flyer 4



Video Still, Eminem at The Rhythm Kitchen 5



After Stanley's

- After Stanley's closed in 1995, the building was vacant for a short time
- Between early 2000s and 2012, the building was sold to two different church congregations – Omega Baptist and Grace Fellowship Church
- During these years, the original interior features were removed
- By 2013, the building had been left abandoned
- In 2018, the building's historic significance was recognized by being designated as a local historic district by the Detroit Historic District Commission

Source - *Historic Detroit - Stanley Hong's Mannia Cafe*, 27



Grace Fellowship Baptist Church

10



Building post 2013 with graffiti

32



Building post 2015 painted facade

33



Nathan Johnson

- Born in 1925 in Herington, Kansas
- Came to Detroit in 1950 w/ architectural degree from Kansas State University
- Employed at White and Griffin as draftsman and then later at Harold H. Fisher and Victor Gruen & Associates
- Johnson established own firm in 1956
- Johnson developed a modern sensibility, designed many churches with modest budgets using easy to use materials
- Johnson's firm had anywhere between 2 and 40 employees during its long practice
- In the 1980s, Johnson was given the opportunity to design all of downtown's People Mover Stations, an opportunity that he shared by subcontracting several stations to African-American peers Aubree Agee, Roger Margerum, and Sims and Varner

Source - *Designing the Future*, 29



Nathan Johnson, 1991

11



Nathan Johnson, 2019

12



Johnson's Original Design of Bethel AME Church

34





Bethel AME Church

13



Hong Residence

14



Thunderbird Inn

15



Second Baptist Church Addition

16



People Mover Station in Downtown Detroit

16





Norm's Diner by Louis Armet & Eldon Davis. Los Angeles, CA

17



Pann's by Eldon Davis & Helen Liu Fong. Los Angeles, CA

18



La Concha Motel Lobby by Paul Williams. Las Vegas, Nevada

19



MacDonald's by Stanley Clark Meston. Los Angeles, CA

20

Googie

Architecture

Features:

- Upswept roofs
- Curvaceous forms
- Dramatic shapes
- Bold use of glass, steel, neon.

Googie is a type of futurist design characterized by "wide-eyed technological optimism", forms that are symbolic of motion, such as boomerangs, flying saucers, diagrammatic atoms and parabolas, and free-form designs such as "soft" parallelograms.

The Googie style represented American society's fascination with Space Age themes and marketing emphasis on futuristic designs. It made the future accessible to everyone - unpretentious and designed to appeal to the average, middle-class American.

Born in southern California, Googie style was popular partly due to the increase of automobile transportation and freeways. Businesses wanted buildings that drew more attention from the street through increasing degrees of weirdness.

Source - Googie, Architecture of the Space Age, 30





APPENDIX D

Precedent Studies



CaixaForum

Madrid, Spain

Architect: Herzog & de Meuron

This former power station was turned into a contemporary art center which includes galleries, offices, a restaurant, and an auditorium. The roof extension's sculptural silhouette reflects the roovescape of the surrounding buildings.

Source - 21



St. Ann's Warehouse

Brooklyn, New York

Architect: Marvel Architects

This former 150-year-old tobacco warehouse was transformed into a performing center with theater spaces, offices, and a large public foyer. A new glass brick clerestory cantilevers off a new steel structure over the top of the existing walls.

Source - 22



Motown Museum Expansion

Detroit, Michigan

Architect: Perkins & Will, Hamilton-Anderson

The proposed expansion of the Motown Museum will add 50,000 square feet of exhibition space, performance venues, recording studios, gathering space, and retail. Viewed from the street, the facade of the addition, located on the lots behind the houses, creates a backdrop for the original building.

Source - 23





Texture Museum

Kortrijk, Belgium
Architect: noArchitecten

This former 100-year-old dispatching warehouse for flax thread is located by the River Leie, which locals refer to as the “golden river”. The design for the adaptive re-use as the new Texture Museum includes a roof extension, clad in gold as an allusion to the river.

Source - 24



Rotermann's Quarter

Tallinn, Estonia
Architect: Hayashi-Grossschmidt Arhitektuur

This former 150-year-old industrial food production facility is situated in the center of the city and under heritage protection. The adaptive re-use of this building included a 2-story addition to transform it into a mix-use building with ground floor retail and office spaces above.

Source - 25



Moritzburg Museum

Halle, Germany
Architect: Nieto Sobejano Arquitectos

This ancient Gothic castle has housed an extensive collection of paintings since 1904. The expansion designed by Nieto Sobejano Arquitectos included a new roof extension that allows natural light to filter into the gallery spaces below.

Source - 26





APPENDIX E

Structural Report

Stanley Hong's Mannia Café Renovation and Addition

Basis of Design Narrative

INTRODUCTION

The existing building located at 249 E Baltimore, Detroit, MI 48202, is a historic modernist landmark, originally designed by Nathan Johnson and listed with the Detroit Historic District Commission. The structure has a distinctive swooping concrete facade facing the street and parking lot (south and west elevations), and CMU walls facing the side and alley (north and east elevations). The interior of the building is completely gutted; all that remains is the interior steel framing and slab on grade floor. The existing roof, which is in poor condition with areas that have failed, is a flat metal deck roof supported by steel framing that spans to interior steel columns and exterior masonry block perimeter walls at the back two walls and exterior steel framing at the front two walls.

The proposed conversion of the building into a music venue will require the partial demolition of the existing roof to raise it to the required height clearance needed to provide functionality for the intended program. It will also require a portion of the first-floor level to be lowered. The renovations also include a horizontal addition to the east of the building extents, which will house a smaller venue and bar and lavatories.

REFERENCE DOCUMENTS

END Studio provided Silman with Schematic Design drawings in pdf format, as well as a Revit 2021 model for use in developing the contents of this report.

GEOTECHNICAL INFORMATION

At the time this report was generated, the Owner was soliciting geotechnical engineering services to provide recommendations on the existing and new foundations needed for the proposed renovations. That information will be provided in a subsequent report.

STRUCTURAL DESCRIPTION

The single story, existing building, with a footprint of about 75ft by 92ft and a roof height about 12ft above ground, is steel framed with a concrete foundation and CMU perimeter. The north and east walls are exposed CMU block while the south and west walls, which are adjacent to the street and parking lot, have a decorative curving precast concrete arcade exterior. The southwest corner of the building, directly above the entrance, has a decorative concrete fin that sticks up above the roofline, provide an elevated face to install signage.

Foundation

The first floor of the structure is a single elevation slab on grade. It is currently assumed that the building is supported on shallow concrete foundations: spread footings beneath the interior columns and strip footings below the perimeter walls. This will be confirmed during the subsurface exploration scope of services that will begin in the coming months.

Framing

Interior tube-shaped steel columns, approximately 4" x 4" with a clear height of about 12 feet, support the structure's roof framing. Wide-flange steel girders, with infill steel beams, span to interior columns and exterior CMU walls. It appears that at some, if not all, CMU walls, there are interior steel columns within the walls to which the roof steel frames. The girders and supported infill framing support a metal roof deck, which has collapsed in two locations. The steel and block walls are in fair condition, though where the roof has collapsed and been compromised the steel and block wall are in fair to poor condition.

Lateral

Due to the age and construction of the building, it is believed that the lateral force resisting elements of this building is the masonry elements on all four perimeter walls.

STRUCTURAL DESIGN GUIDELINES

Applicable Codes & Standards

Local Building Codes

Work is to comply with the latest edition of the local building codes, which are:

- 2015 Michigan State Building Code
- 2015 Michigan Rehabilitation Code for Existing Buildings

These are Michigan Construction Code amendments to the 2015 International Code Council model codes.

National Building Codes

The International Code Council model codes that govern this project are the following:

- 2015 International Building Code (IBC)
- 2015 International Existing Building Code (IEBC)

National Reference Standards

The following standards will be followed as specified by the above-mentioned governing codes:

- ASCE 7-10 Minimum Design Loads (and Associated Criteria) for Buildings and Other Structures
- ACI 318-14 Building Code Requirements for Structural Concrete
- ACI 530-13 Building Code Requirements for Masonry Structures
- AISC 360-10 Specification for Structural Steel Buildings
- NDS-2015 National Design Specification (NDS) for Wood Construction with 2015 Supplement
- ASCE 41-13 Seismic Evaluation and Retrofit of Existing Buildings

Structural Loads

Risk Category

The ASCE 7 and IBC use ‘Risk Category’ to classify buildings “based on risk to human life, health, and welfare associated with their damage or failure by nature of their occupancy or use...for the purposes of applying flood, wind, snow, earthquake and ice provisions.” The Risk Categories range from I (low risk to human life) to IV (essential facility). Stanley Hong’s is to be considered a Risk Category II building (IBC 2015, Table 1604.5).

Superimposed Dead Loads

The following values for superimposed dead loads are assumed in the development of the structural analysis:

Material or Component	Uniform (<i>psf</i>)
MEP* + Ceiling	15
Roofing + Insulation	5
Roof Sheathing	10
Partitions	15

*MEP indicates standard equipment sizes and weights. Should heavier equipment be needed than the above allocation, designs in those areas to support that heavier equipment will deviate from the designs presented in this report. MEP weights and their impact on the structure will be studied in more depth in the next phase of design.

Live Loads

The following values are specified by the applicable codes and standards:

Occupancy or Use	Uniform (<i>psf</i>)
First Floor Retail and Corridors	100
Non-Activated Roof	20

Snow Loads

The following loads and parameters are specified by the applicable codes and standards:

- Ground Snow Load (*ASCE 7-10 Figure 7-1*) $p_g = 20\text{psf}$
- Terrain Category/*Surface Roughness Category (7-10, §26.7)* B
- Exposure Factor (*ASCE 7-10, Table 7-2*) $C_e = 0.9$
- Thermal Factor (*ASCE 7-10, Table 7-3*) $C_t = 1.0$
- Importance Factor (*ASCE 7-10, Table 1.5-2*) $I_s = 1.0$
- Flat Roof Snow Load (*ASCE 7-10, Eqn. 7.3-1*) $p_f = 20\text{ psf (code minimum)}$

Flood Loads

Per FEMA, the location of Stanley Hong's, is within an "area of minimal flood hazard." Therefore, flood design is not applicable.

Wind Loads

- Basic Wind Speed (*by jurisdiction*) $V = 115\text{ mph}$
- Wind Directionality Factor (*ASCE 7-10, Table 26.6-1*) $K_d = 0.85$
- Wind Importance Factor (*ASCE 7-10, Table 6-1*) $I = 1.0$
- Exposure Category (*ASCE 7-10, §26.7*) B
- Topographic Factor (*ASCE 7-10, §26.8*) $K_{zt} = 1.0$
- Ground Elevation Factor (*ASCE 7-10, Table 26.9-1*) $K_e = 1.0$
- Gust Effect Factor (*ASCE 7-10, §26.9*) $G = 0.85$
- Enclosure Classification (*ASCE 7-10, §26.10*) Enclosed
- Internal Pressure Coefficient (*ASCE 7-10, Table 26.11-1*) $GC_{pi} = +/-0.18$
- Velocity Pressure (*ASCE 7-10, Eqn. 26.10-1*) $q_z = 19\text{ psf}$
- Design Wind Pressure (*MWFRS*) $p = 22\text{ psf}$
- Design Wind Pressure (*C&C*) $p = 20\text{-}25\text{ psf}$

Seismic Loads

The seismic parameters dependent on soil shall be confirmed by a geotechnical engineer.

The seismic force-resisting system has been assumed as _.

- Soil Site Class (*Assumed*) D
- Short Period Mapped Spectral Accel. (*USGS*) $S_s = 0.095g$
- One Second Period Mapped Spectral Accel. (*USGS*) $S_1 = 0.047g$
- Short Period Design Spectral Acceleration $S_{DS} = 0.102g$
- One Second Period Design Spectral Acceleration $S_{D1} = 0.075g$
- Seismic Design Category (*ASCE 7-10, §11.6*) B
- Seismic Importance Factor (*ASCE 7-10, Table 1.5-2*) $I_e = 1.0$
- Response Modification Coeff. (*ASCE 7-10, Table 12.2-1*) $R = 1.5$
- Overstrength Factor (*ASCE 7-10, Table 12.2-1*) $\Omega_o = 2.5$
- Deflection Amplification Factor (*ASCE 7-10, Table 12.2-1*) $C_d = 1.25$

Structural Irregularities					
Horizontal Type			Vertical Type		
		Applies?		Applies?	
1a	Torsional Irregularity	Yes/No	1a	Stiffness Irregularity – Soft Story	Yes/No
1b	Extreme Torsional Irregularity	Yes/No	1b	Stiffness Irregularity – Extreme Soft Story	Yes/No
2	Re-entrant Corners	Yes/No	2	Weight (Mass) Irregularity	Yes/No
3	Diaphragm Discontinuity	Yes/No	3	Vertical Geometric Irregularity	Yes/No
4	Out-of-Plane Offset	Yes/No	4	In-Plane Discontinuity in Vertical LFRS Element	Yes/No
5	Nonparallel System	Yes/No	5a	Discontinuity in Lateral Strength – Weak Story	Yes/No
			5b	Discontinuity in Lateral Strength – Extreme Weak Story	Yes/No

For non-structural components:

- MEP systems are to be braced against seismic forces and provided with appropriate joints to allow seismic movement.
- All masonry partitions will require positive attachment to the structure.
- Non-structural components to meet life safety performance level in design level earthquake per ASCE 41-13/IBC Chapter 34/ASCE 7-10 Chapter 13.

Serviceability

The serviceability criteria shall be the most restrictive of either those in applicable code reference, or those presented below:

Gravity Deflections

- For roof members live/snow load deflection shall not exceed $l/240$, and the dead + live load deflection shall not exceed $l/180$.
- For floor members the live load deflection shall not exceed $l/360$, and the dead + live load deflection shall not exceed $l/240$.
- For members supporting plaster ceilings the live load deflection shall not exceed $l/480$, and the dead + live load deflection shall not exceed $l/360$.
- For members supporting masonry walls the dead + live load deflection shall not exceed $l/600$.

Lateral Deflections

- Allowable story drift due to seismic is $.007 \times$ story height (*ASCE 7-10, Table 12.12-1*).
- Allowable lateral deflection due to wind shall be $h/400$ typically, or $h/600$ for walls with sensitive finishes, where h is the story height.

Vibrations

No criteria have been provided to limit vibrations for sensitive equipment or sensitive historic fabric. Where human comfort is the criteria for limiting pedestrian induced motion, floor framing vibration due to footfall vibrations will be verified. Where vibrations are caused by running machinery, they should be isolated by damping devices or using independent foundations.

STRUCTURAL MATERIAL SPECIFICATIONS

For new structural elements, it is assumed the provided materials will meet the following specifications:

Concrete

- Compressive Strength f'_c = 4000 psi typical, 3000 psi at slab on deck, 5000 psi and higher if required for design
- Concrete Density γ = 150 pcf normal weight, 115 pcf lightweight
- Reinforcing Bars ASTM A615 Grade 60
- Welded Wire Fabric ASTM A1064 (65 ksi min. yield)

Steel

- Historic Steel Steel yield strength: f_y = 30 ksi (assumed)
- Wide Flange ASTM A992
- Hollow Structural Sections ASTM A500, Grade B
- Structural Pipe Sections ASTM A53, Grade B
- Channels, Angles & Plates ASTM A36
- High Strength Bolts ASTM A325
- Welding Electrodes
 - Preheat and low hydrogen electrodes are assumed to be required. Welding parameters will be determined from forthcoming metallurgic testing. All welding to be done under strict guidance and recommendations of a metallurgist or welding engineer certified in welding procedures.

Masonry

Concrete block shall be of lightweight aggregate and conform to the following standards: solid/hollow block: ASTM C90, Grade N1.

Net area compressive strength of concrete masonry <u>unit</u> , psi	Net area compressive strength of masonry <u>assembly</u> , f'_m , psi (using Type S mortar)
1900	1500
2800	2000
3750	2500

existing structure's lateral system by more than 10%, the existing building needs to comply with current IBC wind and seismic criteria.

Based on the proposed renovations identified in the following section, Silman believes that a full structural analysis and potential upgrade of the building is warranted. Therefore, the structural modifications needed to realize the intended program will be designed to ensure the building can support full and current gravity, wind and seismic loading as prescribed in the current Michigan State Building Code for new construction.

PROPOSED RENOVATIONS

The proposed renovations have been illustrated in a schematic design package developed by END Studio for Silman's review. Silman has developed conceptual structural modifications that would support the intended architectural designs; the modifications are narrated in the following section.

Structural Renovations

The proposed conversion of the building into a music venue will require the partial demolition of the existing roof to raise it to the required height clearance that will provide functionality for the intended program. Given the need to remove most of the existing roof to raise the building height, together with the areas of roof that have collapsed and are damaged, we recommend that the entire roof deck be removed and replaced. This will require the general contractor hired to complete the work to provide shoring to temporarily support the tops of the existing perimeter masonry walls and columns during construction until a new roof is installed.

As shown in the architectural renderings, the venue modifications are concentrated toward the northeast corner of the building, and all roof framing and interior columns within the pop-up space will need to be removed to account for the program requirements. The delineation of spaces, however, allows the westernmost internal column line to remain. The westernmost column line and the existing roof framing between it and the west exterior wall will be assessed to determine whether it can remain to support the new roof. If it cannot remain, new framing will be installed.

The southernmost roof framing may be salvaged as well if the existing steel can support the new roof. However, the interior columns supporting the southernmost girders are within the space to be renovated; therefore, they need to be removed. If the southern girders and infill beams are to be salvaged and reused, new steel columns and concrete spread footings can be installed under the southern girders where new interior walls are to be located (so the columns can be hidden behind finish) before the girders are cut shorter. Therefore, part of the southern girders and infill beams can be salvaged and the steel extending northward into the elevated space can be cut and removed.

The new roof over the lower western and south ends of the building will be lightweight metal deck and roofing so the assumption currently is that the new roof deck and roofing materials are similar in weight to the original roofing and the existing steel will be able to support the new roofing. There may be some steel that needs to be repaired and recoated due to water damage but that will be determined during design development and on-site investigations.

The elevated roof framing toward the northeast of the building will require all the steel roof framing and columns within that space to be removed. The program also wants the central area beneath the pop-up to be column-free; therefore, the new roof framing needs to span approximately 60'. Large wide flange girders, built-up plate girders or steel trusses need to span over this open space. These large girders will be supported by a series of existing and new steel columns along the western end of the building and the easternmost existing block wall.

The existing western columns outside of the pop-up are that could remain, if they can support the new roof loads, will need new stub columns placed on top of them to reach up to the new roof height. The large girders not only have to span across the large, column free space, they need to support new roofing loads, including potential rooftop equipment above and theatrical rigging loads below. Therefore, the existing columns at the west and block wall at the east may not be able to support such heavy loads and will need to be replaced with new columns on new foundations, which will require the partial removal and replacement of the easternmost block wall.

The new music venue will also require a portion of the first-floor level to be lowered. Given the large amount of existing slab on grade that needs to be removed for this lowered space and the number of new reinforced cast in place concrete footings that need to be installed where new columns are to be placed, it is recommended that the entire existing slab on grade be removed and replaced with new slab on grade that steps to accommodate the change in elevation between the entry and amenities levels and the stage and viewing areas.

There may be areas that require local underpinning of the existing footings to accommodate the depressed slab area should the existing foundations not be deep enough. The areas that could potentially require localized underpinning are the footings beneath the existing interior columns and the east and north perimeter walls footings. Furthermore, if the depth of the existing foundations cannot accommodate the slab depression, they may need to be cut down and underpinned or removed and replaced altogether.

The east addition will be new construction composed of perimeter block walls (or light gage or wood walls depending upon cost implications and code allowances) supported on concrete shallow foundations. The roof framing will be new metal deck supported on steel framing that

spans between the new easternmost exterior block wall and the new steel columns along the original east exterior block wall.

Live Load Analysis

The original use for the building consisted of a commercial space. The new program would realize similar occupancies in the building. Therefore, the live load between original and future uses will remain about the same in terms of live loading.

Wind and Seismic Analysis

The renovation will remove most of the existing roof and roof framing to elevate the roofline for the intended program space. This will both increase the wind load (surface area) and seismic loading (weight) of the building, requiring a full analysis of the existing building and potential new lateral elements. The current idea is that new steel braced frames on the interior and reinforced masonry perimeter walls along the exterior can be installed to provide an updated lateral design that will comply with full and current code-required loading.

Exterior Concrete Elements

The exterior decorative concrete features at the south and west elevations will need to be studied in the next stage of design. The precast arcade and corner projection are decorative/non-structural elements that appear to be in fair condition. However, the adequacy of their connections back to the main structure should be assessed. This will involve some exploratory work at the roofline and potential up-close surveying of the corner projection by means of a lift. Any concrete deterioration will need to be patched/repaired and possible new anchorage of panels to each other and back to the main structure (the block walls and steel) may need to be developed and installed.

CONCLUSIONS & NEXT STEPS

The next immediate step following this concept study is to complete the subsurface exploration. This information will allow us to determine with certainty any underpinning or removal of existing foundations that may be needed due to the depressed slab for the music venue. It will also allow us to determine the capacity of the existing foundations to support the restructured building.

Another step that we will be doing as we move into design development is assessing the exterior concrete decoration (precast arcade panels and corner projection). This will involve some localized probes at the rooftop to observe the panels attachment back to the perimeter walls and allow up-close review of the concrete condition.

Finally, as we move into the next stages of design, we will start developing the full structural design for the new gravity and lateral frames needed for the future programming.

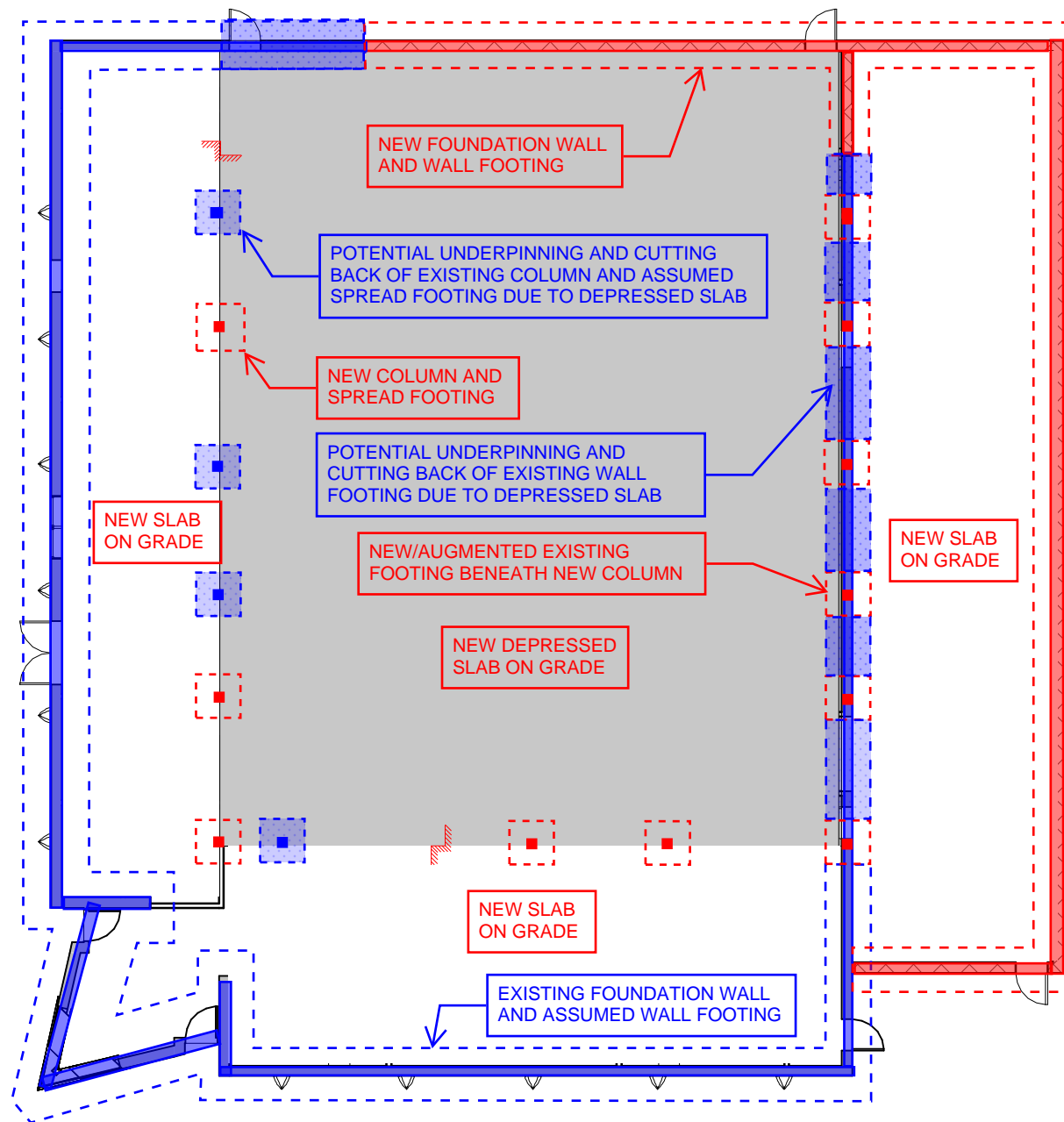

FOUNDATION PLAN

NOTE: THIS IS CONCEPT STUDY ONLY AND FRAMING EXTENTS MAY CHANGE DURING DESIGN. INFORMATION PROVIDED IN SCHEMATIC ONLY INTENDED TO SHOW RANGE OF WORK THAT COULD BE INVOLVED IN RENOVATING BUILDING

Title: STANLEY HONG'S RENOVATIONS - CONCEPT STUDY: FOUNDATION PLAN

Date: 10/13/2021
Scale: 1/16" = 1'-0"



211 N. Fourth Avenue, Suite 2A, Ann Arbor, MI 48104
734 800 2460

Job Number: 20413

Job Title:
STANLEY HONG'S RENOVATION

Reference:

SSK-01

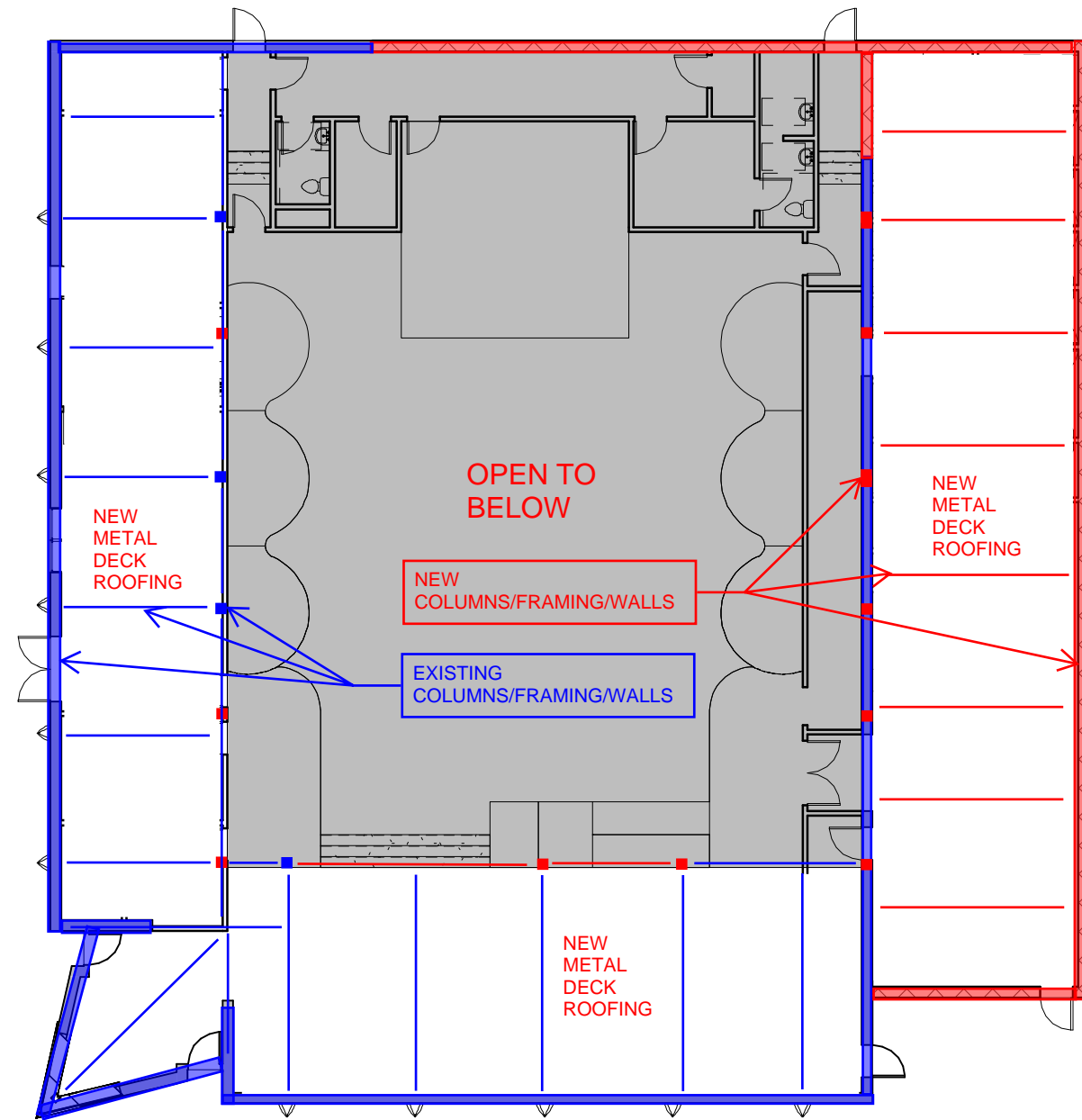

LOW ROOF GRAVITY FRAMES

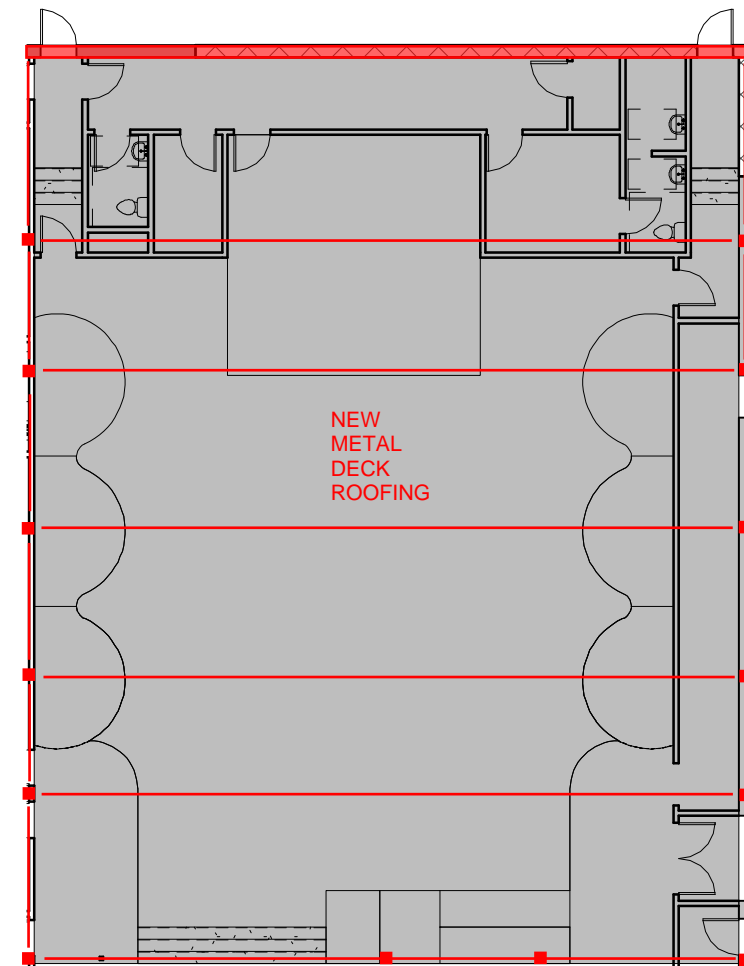

HIGH ROOF GRAVITY FRAMES

NOTE: THIS IS CONCEPT STUDY ONLY AND FRAMING EXTENTS MAY CHANGE DURING DESIGN. INFORMATION PROVIDED IN SCHEMATIC ONLY INTENDED TO SHOW RANGE OF WORK THAT COULD BE INVOLVED IN RENOVATING BUILDING

Title: STANLEY HONG'S RENOVATIONS - CONCEPT STUDY: ROOF FRAMING

Date: 10/13/2021
Scale: 1/16" = 1'-0"



211 N. Fourth Avenue, Suite 2A, Ann Arbor, MI 48104
734 800 2460

Job Number: 20413

Job Title:
STANLEY HONG'S RENOVATION

Reference:

SSK-02

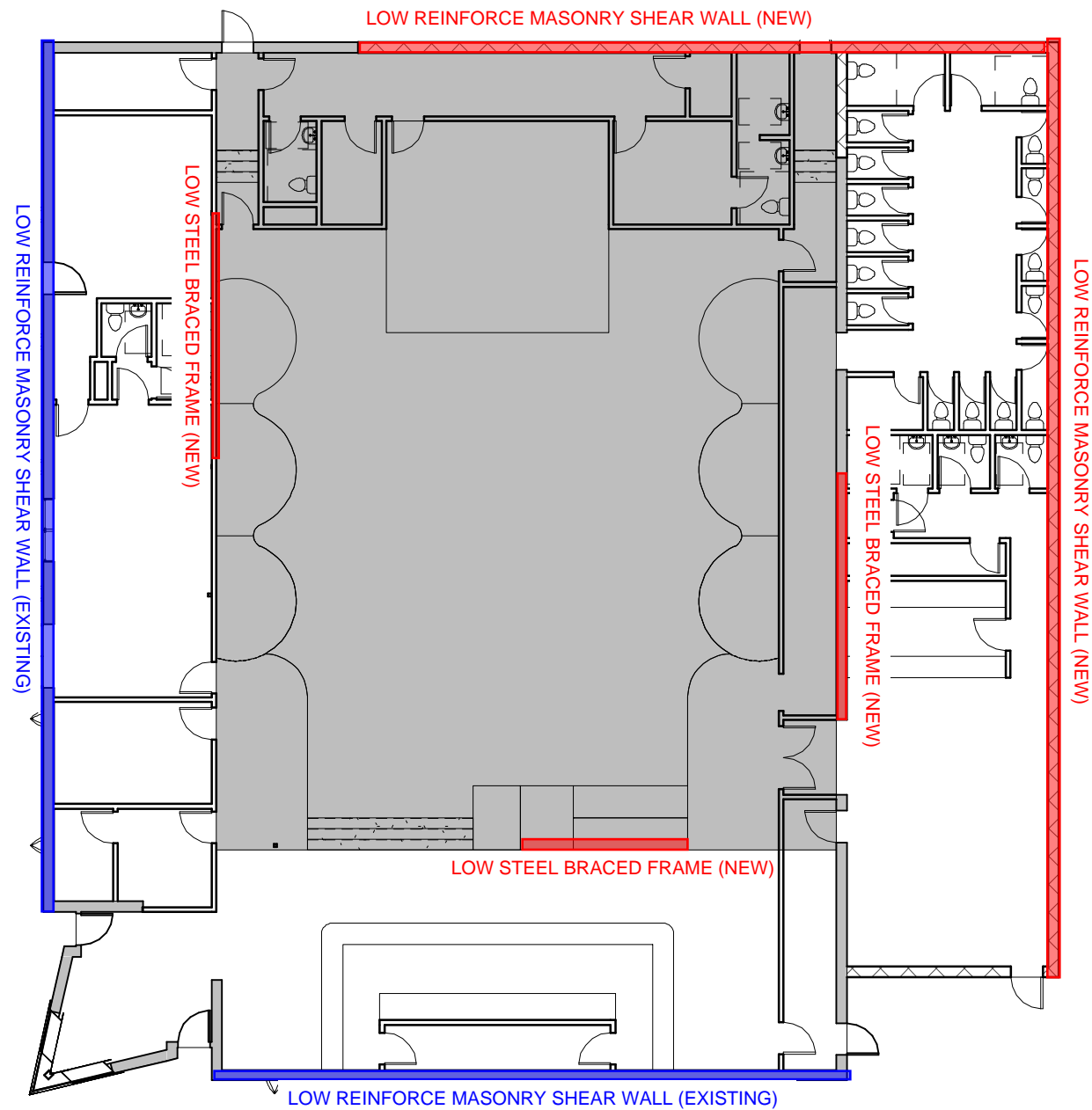

LOW ROOF GRAVITY FRAMES

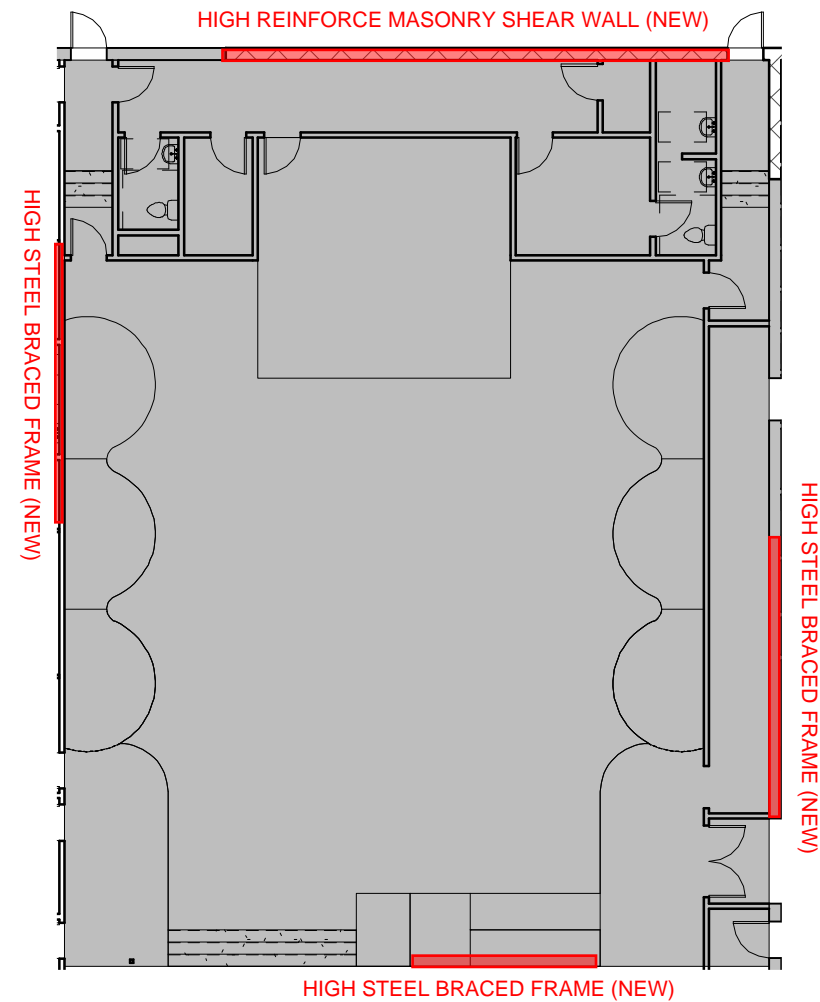

HIGH ROOF GRAVITY FRAMES

NOTE: THIS IS CONCEPT STUDY ONLY AND FRAMING EXTENTS MAY CHANGE DURING DESIGN. INFORMATION PROVIDED IN SCHEMATIC ONLY INTENDED TO SHOW RANGE OF WORK THAT COULD BE INVOLVED IN RENOVATING BUILDING

Title: STANLEY HONG'S RENOVATIONS - CONCEPT STUDY: LATERAL DESIGNS

Date: 10/13/2021
Scale: 1/16" = 1'-0"



211 N. Fourth Avenue, Suite 2A, Ann Arbor, MI 48104
734 800 2460

Job Number: 20413

Job Title:
STANLEY HONG'S RENOVATION

Reference:

SSK-03



APPENDIX F

Product Specifications

TYPICAL EIFS CONFIGURATION

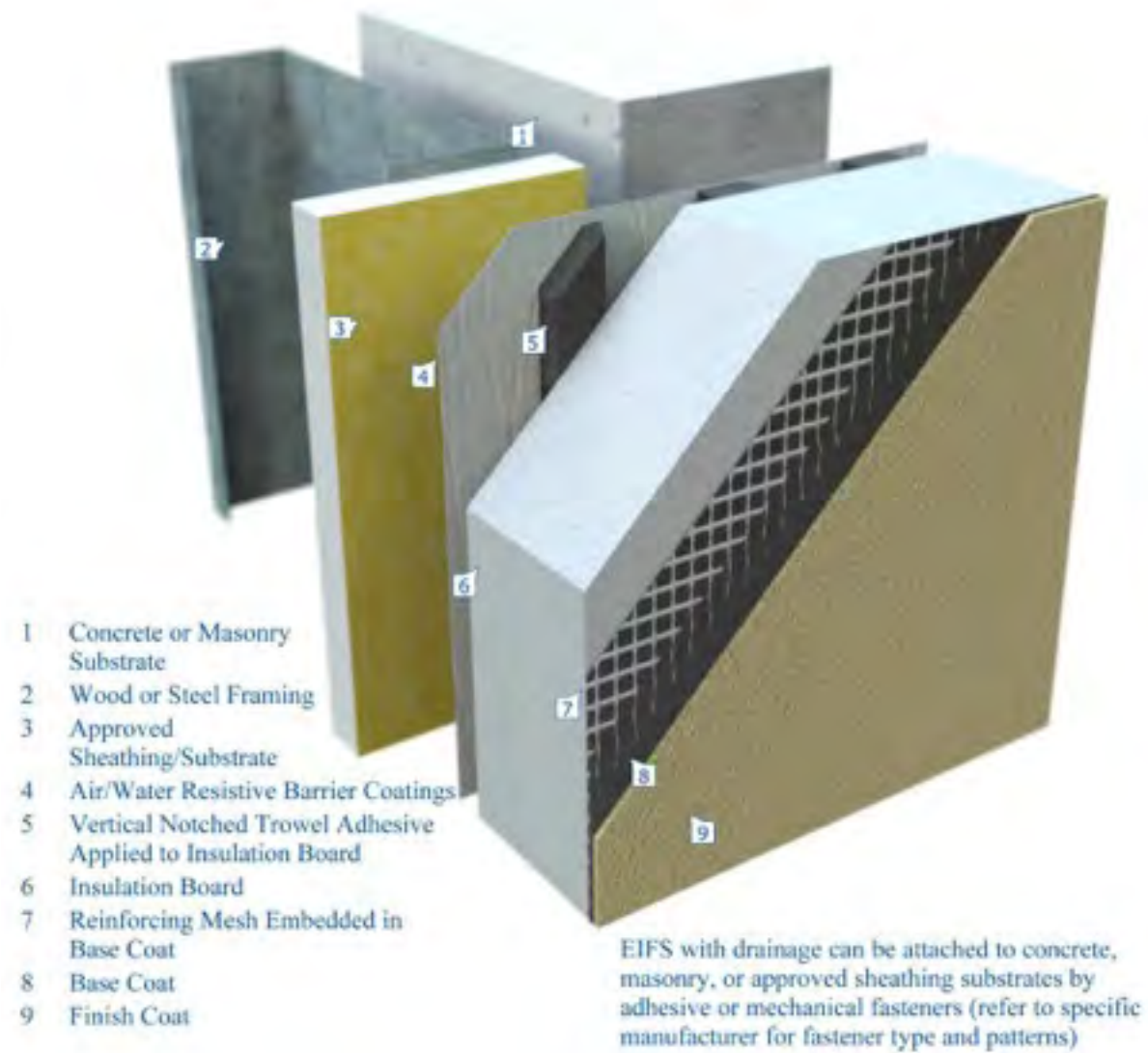

EIFS texture sample - fine

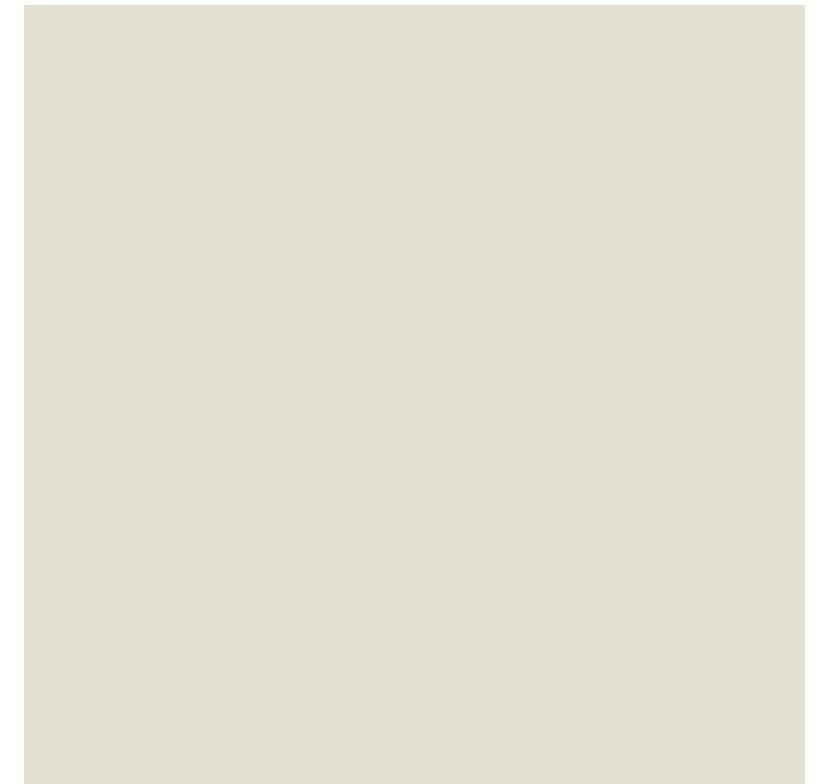

EIFS color sample - Benjamin Moore OC-46 Halo



ALL NEW ROOFING TO BE TPO:

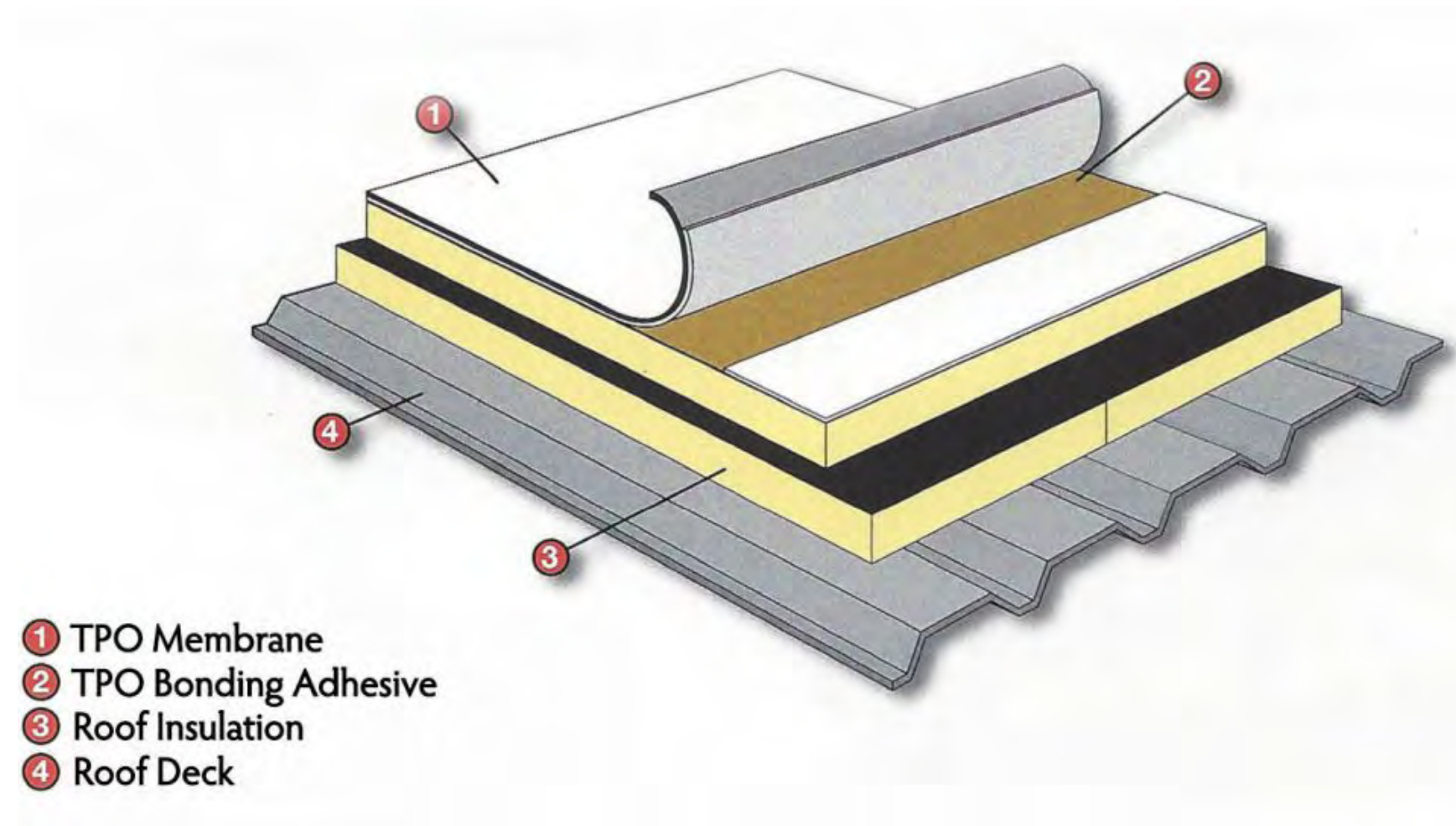

ALL EXISTING METAL ROOFING TO BE REPAIRED

ALL VISIBLE ROOFING ON HISTORIC BUILDING TO MATCH HISTORIC BLACK RUBBER



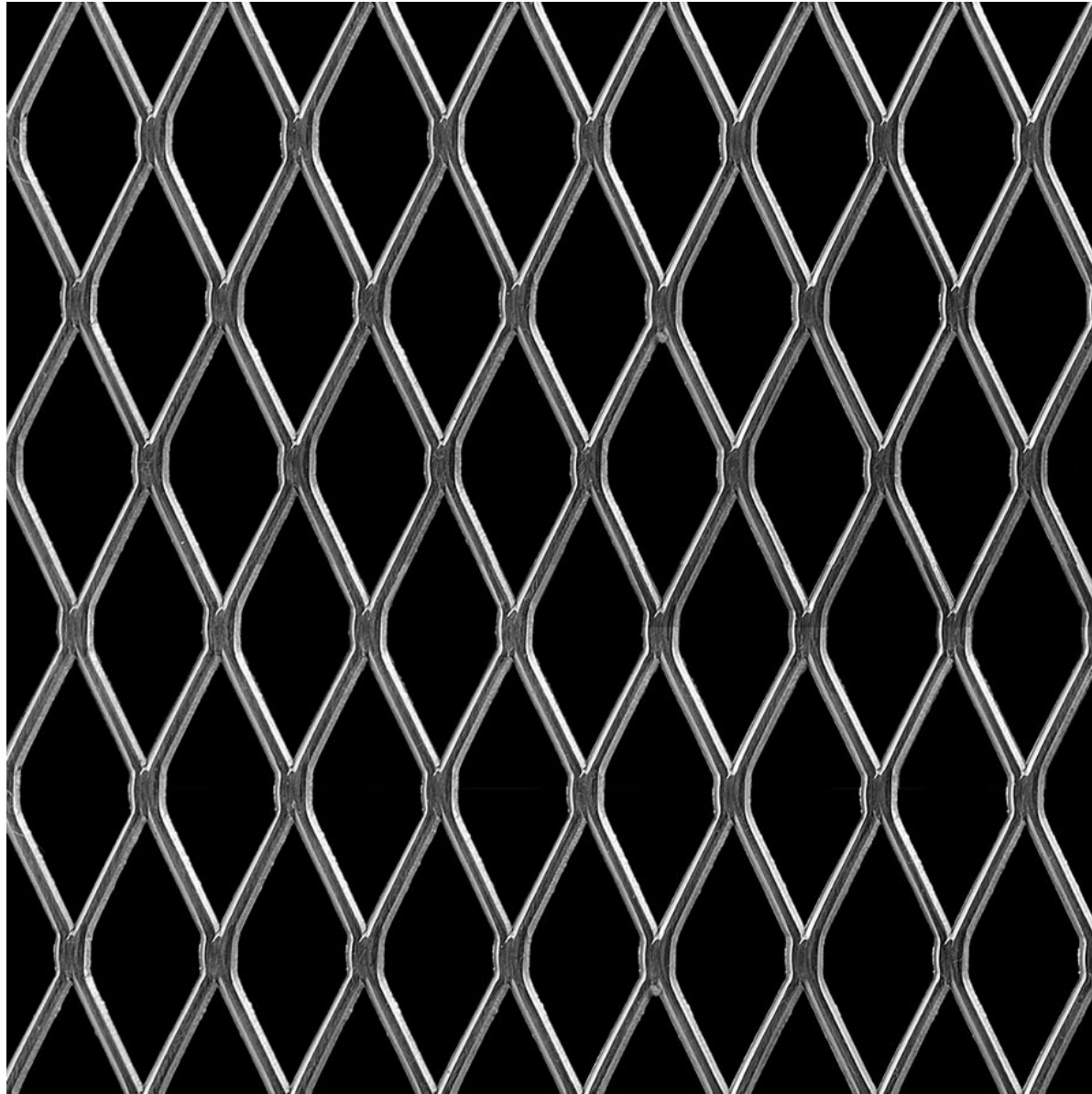

Rooftop Addition Mesh Sample

Finish - dark gray powder coat to meet and exceed the performance requirements of AAMA 2604

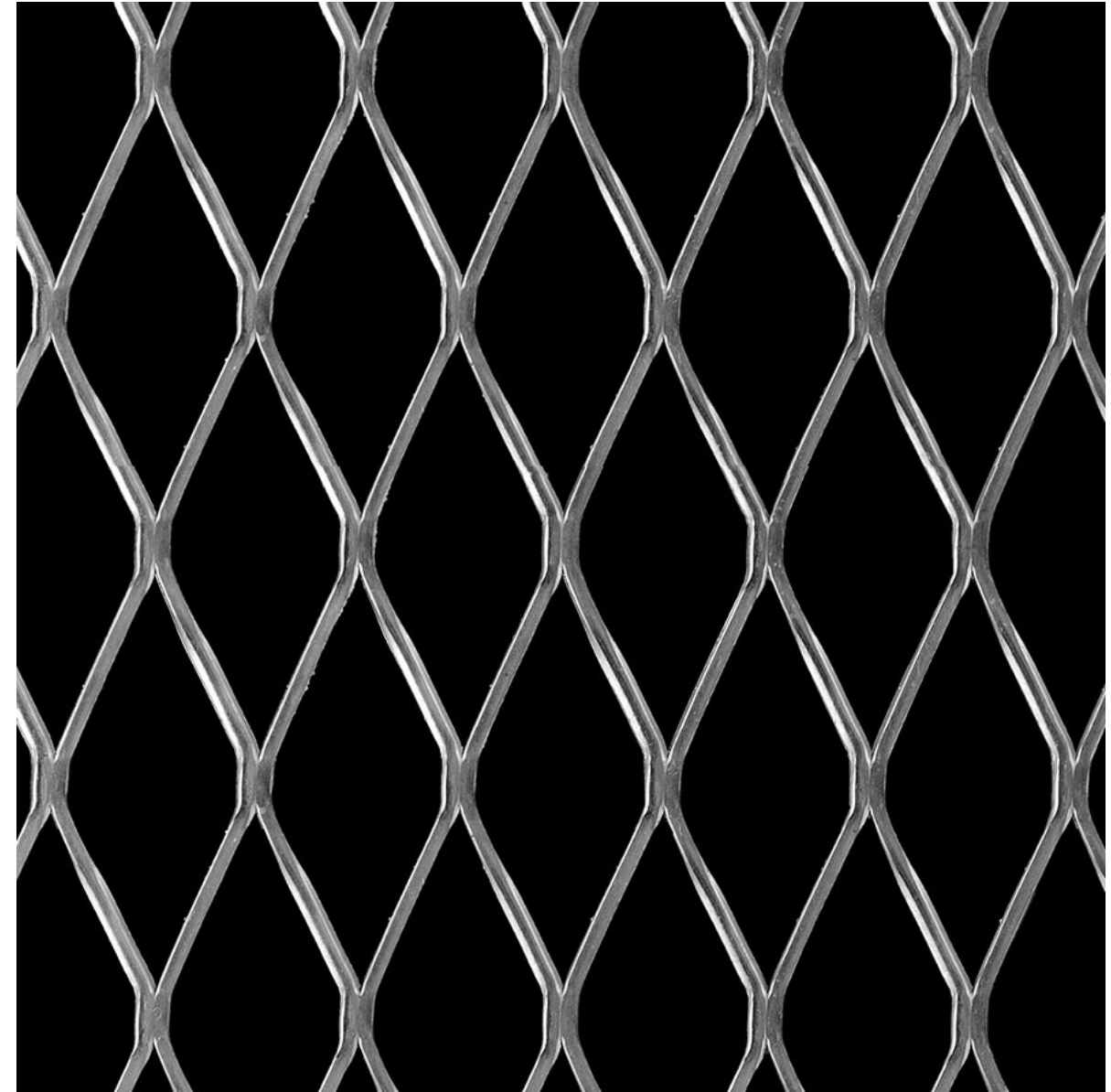

Lounge Facade Mesh Sample

Finish - clear



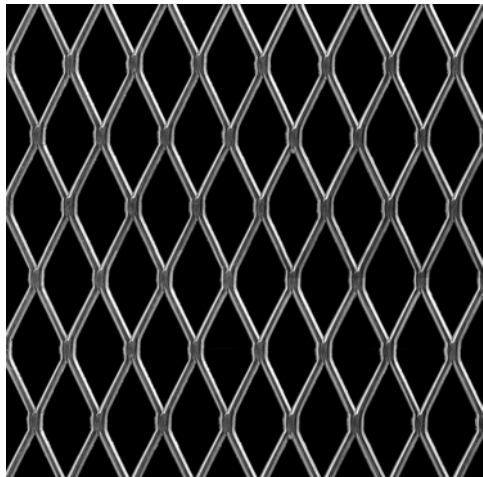

McNICHOLS® EXPANDED METAL

Flattened, Stainless Steel, Type 304, 3/4" No. 13 Flattened, 79% Open Area

McNICHOLS® Expanded Metal, Flattened, Stainless Steel, Type 304, Mill Finish, 3/4" No. 13 Flattened, 0.923" Short Way of Design (SWD), 2.100" Long Way of Design (LWD), Long Way of Opening (LWO) Parallel to Length of Sheet, 79% Open Area

ITEM 5800341348 - 48" x 96"

ITEM SPECIFICATIONS

Item Number	5800341348
Product Line	Expanded Metal
Expanded Type	Flattened
Primary Material	Stainless Steel (SS)
Alloy, Grade or Type	Type 304 (304)
Material Finish	Mill Finish
Style & Type	3/4" No. 13 Flattened
Design Size - Short Way of Diamond (SWD)	0.923"
Design Size - Long Way of Diamond (LWD)	2.100"
Opening Size - Short Way of Opening (SWO)	0.667"
Opening Size - Long Way of Opening (LWO)	1.653"
Long Way of Opening (LWO) Parallel to	Length of Sheet
Diamonds per Foot - Short Way of Diamond (SWD)	13.0
Diamonds per Foot - Long Way of Diamond (LWD)	5.7
Strand Thickness	0.076"
Strand Width	0.101"

FINISH: dark grey powder coat to meet and exceed the performance requirements of AAMA 2604



Overall Thickness	0.076"
Percent Open Area	79%
Weight	0.82 Lbs./Square Foot
Product Form	Sheet
Sizes (Width x Length)	48" x 96"; 60" x 120" (Cut Sizes Available)
Specifications Note	Specifications May Vary Slightly Within Mill Tolerances

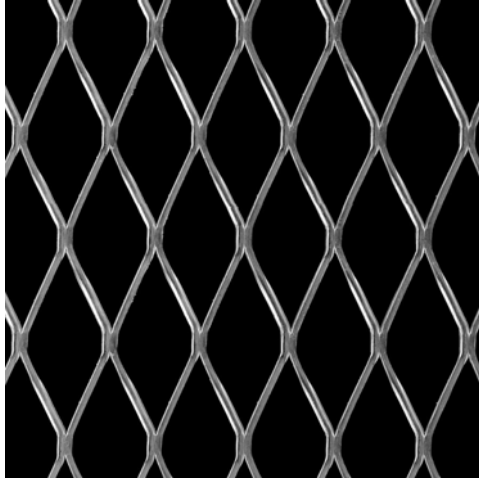

McNICHOLS® EXPANDED METAL

Flattened, Stainless Steel, Type 304, 1-1/2" No. 13 Flattened, 83% Open Area

McNICHOLS® Expanded Metal, Flattened, Stainless Steel, Type 304, Mill Finish, 1-1/2" No. 13 Flattened, 1.330" Short Way of Design (SWD), 3.200" Long Way of Design (LWD), Long Way of Opening (LWO) Parallel to Length of Sheet, 83% Open Area

ITEM 5800151348 - 48" x 96"

ITEM SPECIFICATIONS

Item Number	5800151348
Product Line	Expanded Metal
Expanded Type	Flattened
Primary Material	Stainless Steel (SS)
Alloy, Grade or Type	Type 304 (304)
Material Finish	Mill Finish
Style & Type	1-1/2" No. 13 Flattened
Design Size - Short Way of Diamond (SWD)	1.330"
Design Size - Long Way of Diamond (LWD)	3.200"
Opening Size - Short Way of Opening (SWO)	1.085"
Opening Size - Long Way of Opening (LWO)	2.613"
Long Way of Opening (LWO) Parallel to	Length of Sheet
Diamonds per Foot - Short Way of Diamond (SWD)	9.0
Diamonds per Foot - Long Way of Diamond (LWD)	3.8
Strand Thickness	0.076"
Strand Width	0.114"

FINISH: clear powder coat that meets and exceeds the performance requirements of AAMA 2604



Overall Thickness	0.076"
Percent Open Area	83%
Weight	0.55 Lbs./Square Foot
Product Form	Sheet
Sizes (Width x Length)	48" x 96" (Cut Sizes Available)
Specifications Note	Specifications May Vary Slightly Within Mill Tolerances



NW ALUMINUM 840

The innovative NW Aluminum 840 provides the slimmest and most thermally efficient aluminum framed system within the Generation 4 Folding Glass Wall by NanaWall product family. Comprised of a host of proprietary features, NW Aluminum 840 brands a new level of aesthetics featuring an extremely streamlined appearance with minimal exposed hardware.

GENERATION ™

Folding Glass Walls by NanaWall



NW ALUMINUM 840 provides the slimmest aluminum frame of the NanaWall Folding Glass Wall product family. With a frame profile styled in a crisp, angular design, the intersection of two folding panels is a mere 3 7/8" (99 mm). Comprised of a host of proprietary and patented features, this floor supported system offers an extremely streamlined appearance with minimal exposed hardware, creating a new level of aesthetics.

MINIMAL SIGHTLINE FOR A MODERN AESTHETIC

Panel frames are slim and contemporary with a total 3 7/8" (99 mm) junction where the two adjacent folding vertical stiles meet. The panel profiles offer a crisp, angular design. Top and bottom rails are a minimal 2 5/8" (66 mm), providing slim-line aesthetics. Panel depth is 3 5/16" (84 mm). To coordinate with design programs, horizontal mullions are possible.

PATENTED MULTIFUNCTIONAL THERMAL BREAK PROFILE AFFORDS SLIM SIGHTLINE

The Bionic Turtle® is a patented (Patent No. US10550625B2) polyamide single piece insulbar design that serves many functions. Not only does it provide an outstanding insulating thermal break within the frame profiles for energy efficiency, it also serves as a concealed channel to house the system's locking rods. By being able to combine functions within one element, the Bionic Turtle design allows the slim profile appearance of NW Aluminum 840.

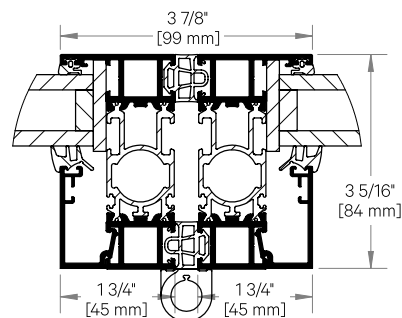



NW Aluminum 840 is capable of unit heights up to 11' 6" (3500 mm) and offers the possibility of wider openings with the integration of FourFold and SixFold Panel Sets that move and stack to either side of the opening, providing the ultimate in layout flexibility. As a custom-built architectural solution, this system is available in inswing or outswing configurations and can accommodate open corner designs.



CONCEALED PANEL ALIGNMENT MEANS LESS EXPOSED PANEL HINGES

The patented (Patent No. US10711510B2) TwinX mechanism aligns panels of over 7' (2150 mm) in height by adding a hidden spring-loaded structural reinforcement feature without the need for an additional exposed hinge in the middle of the system. TwinX interlocks the panels together when the system is closed providing a consistent seal between the panels, specifically engineered to meet higher wind loads.

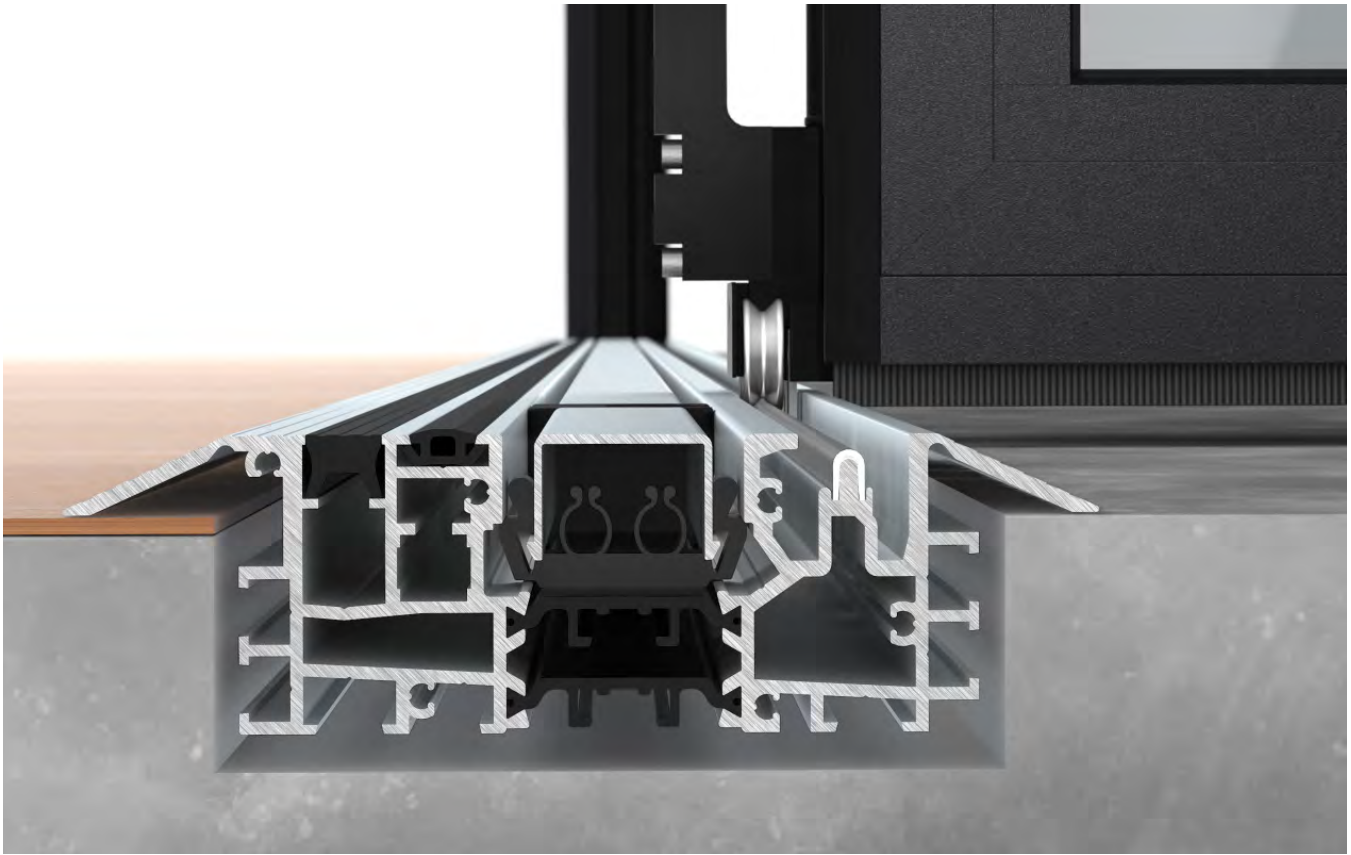

FOUR SILL OPTIONS WITH HIGH HEEL RESISTANT FEATURE

NW Aluminum 840 has four sill options: Hybrid, Low Profile Saddle, Low Profile Saddle with UniverSILL®, and Flush. Standard to all sills is removable aluminum high heel resistant sill inserts. These inserts provide ADA compliance for the Low Profile Saddle and Flush sills and create a very barefoot-friendly transition. Furthermore, the inserts offer protection from dirt and debris collecting in the bottom track.

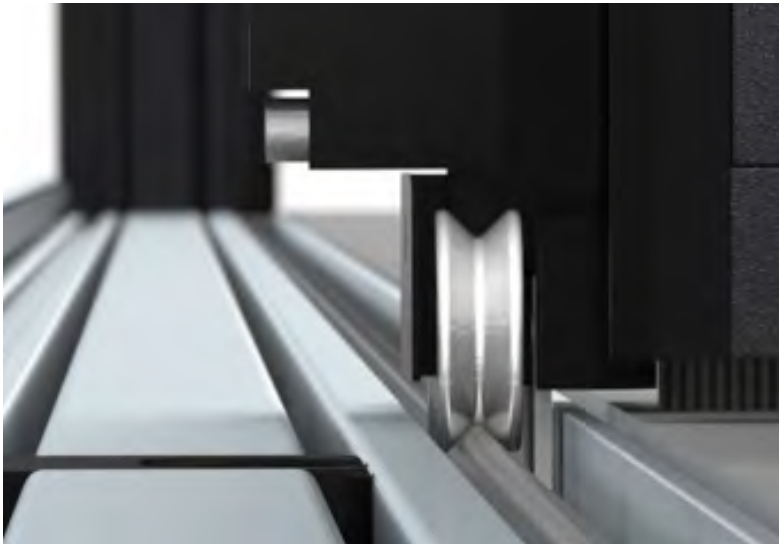

UNIQUE GOTHIC ARCH ROLLER PROVIDES FRICTIONLESS SMOOTH OPERATION

The running carriage rolls above the water table on two stainless steel wheels with a unique Gothic arch design supported by a double row of ball bearings. With a 2-point contact of each wheel to the floor track, the system glides quietly and smoothly with less friction by providing an equal distribution of weight on the stainless steel track.

Black finish - no divided lites





FLOATING LEFT/RIGHT FOURFOLD OR SIXFOLD PANEL SETS FOR WIDER OPENINGS AND FLEXIBLE STACKING PLACEMENT

NW Aluminum 840 is the only floor supported, thermally broken folding system available that allows for larger opening sizes and flexible space management with the integration of FourFold or SixFold Panel Sets. These panel sets are able to move and stack either to the right, left, or center within the same track allowing the panels to be stacked in the most convenient location as needed.

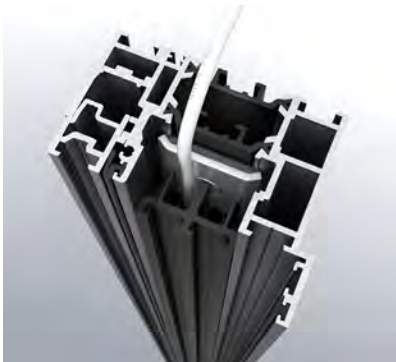

MULTIPURPOSE FRAME INSERT PROVIDES CONTINUOUS SURFACE AT SIDE JAMB AND HEAD TRACK

A black polyamide clip-on multipurpose frame insert conceals all visible frame to structure attachment points and screw heads creating a clean, even appearance. This frame cover piece creates a hollow space to run and guide concealed cabling for the NW Aluminum 840 to connect to a home security system by others. Lastly, in addition to the extra boost to thermal and acoustical performance, the multipurpose insert provides an extra cavity to attach a third weatherseal for environments that require even more extreme thermal protection.



SYSTEM WIDTH ADJUSTMENT FEATURE FOR LONG-TERM TIGHT, CONSISTENT SEALING

System width adjusts with ease. To allow for construction tolerance, a patented (Patent No. US10683688B2) lateral adjustment feature of +/- 3/16" (5 mm) is available at the side jamb. This allows for consistent seal compression within the system and can be adjusted should the need arise.



SWING DOORS FOR TRAFFIC MANAGEMENT

To accommodate traffic flow, swing panels can be added either to the end of a chain of panels for systems with an odd number of panels folding in one direction or hinged to the side jamb, depending on unit height and configuration. An up to 3' 3" (1000 mm) swing panel hinged to the side jamb is available. Swing panels have been tested and passed over 500,000 cycles and can be optionally outfitted with higher kickplates for ADA compliance. Panic hardware and top door closers by others are possible.

NANAWALL PERFORMANCE

As a NanaWall product, the NW Aluminum 840 has been put through rigorous performance testing for air, water, structural, operation, and forced entry. This Generation 4 system is designed from the ground up and, as a result, is our most thermally efficient aluminum framed folding glass wall.

THERMAL EFFICIENCY AND GLAZING OPTIONS

Depending on glass type selected, NW Aluminum 840 is up to 20% more thermally efficient than other NanaWall aluminum framed folding product making it an ideal choice for climates requiring superior thermal performance. The system comes standard with continuous seals along the face of each panel frame. Standard for each system are two levels of insulating thermal breaks for optimal defense from heat and cold. Glass pocket accommodates insulated glass from 7/8" (22 mm) to 2 7/16" (62 mm).

SYSTEM SIZES

Depending on the desired glazing of the unit, maximum panel sizes range. Units can reach heights of 11' 6" (3500 mm) with panel widths up to 3' 7" (1100 mm). Unlimited system widths are possible with the addition of unhinged FourFold or SixFold Panel Sets.



Scan code for more system options and details.



Explore our opening glass wall product families:



Folding



Sliding



Frameless



Minimal Sliding

- NanaWall opening glass walls are sold factory direct through local architectural design representatives across North America. Our Certified Installation Network option ensures correct installation with speed and precision.
- From design to installation—we're here to help. Our Dedicated Design Team can answer your questions and assist with planning, ordering and optimizing your NanaWall options.

THE ONE AND ONLY NANAWALL

NanaWall has reinvented the category of opening glass wall systems. Throughout our 30-plus-year history, we have earned the trust of architects, builders, design professionals and homeowners. As a solutions provider, we reimagine the ways in which buildings, people and the elements interact.

Visit our showrooms and try a NanaWall for yourself.

NanaWall[®]
Boundaries **Unbound**[®]

Nana Wall Systems, Inc.
100 Meadowcreek Drive #250
Corte Madera, CA 94925

800 873 5673
415 383 3148
Fax 415 383 0312

info@nanawall.com
NanaWall.com

GLOBE

White Acrylic Globe
with Machined Top Cover

Catalog #:

Project:

Type:

Date:

Notes:

Electrical

- 120V input (277V available in arm and post option only)
- Integrated power supply allows the fixture to be connected directly into line voltage
- Pre-wired and ready for install
- LED is dimmable with Incandescent/Triac dimmers

Mounting

- 1/2" or 3/4" IP for arms. Flush mount, stems and post available only in 1/2"
- 9' Pendant cord available in black or white cord (includes 5" canopy with the same finish as the shade)

Finishes

- Top cover and mounting finish options
- Available in 21 standard and 2 specialty finishes with optional coastal coating to protect finish in coastal environments (add "-C" to the finish)
- Consult factory for custom finish options

Listing

UL listed to US and Canadian standards for wet locations

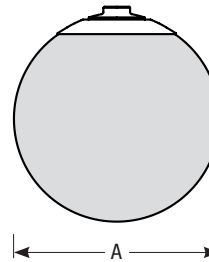

	A
GL12	12"
GL14	14"
GL16	16"
GL18	18"

Globe Order Matrix (Example: GL14LED1827TBZ-2)

Diameter	Lamp / LED	Top Cover Finish	Coastal Coating	Mounting Type
GL12 (12")	M (Medium Base, 100W max.)	ABL Aegean Blue	(blank) (No coating)	-2 (1/2" IP)
GL14 (14")	LED1227 ^{1,2} (12W LED / 2700K / 90 CRI / 844lm)	BB (Burnished Bronze)	-C (Coating)	-3 (3/4" IP)
GL16 (16")	LED1230 ^{1,2} (12W LED / 3000K / 90 CRI / 861lm)	BK (Gloss Black)		-B (Black Cord Pendant)
GL18 (18")	LED1235 ^{1,2} (12W LED / 3500K / 90 CRI / 872lm)	BLU (Blue)		-W (White Cord Pendant)
	LED1240 ^{1,2} (12W LED / 4000K / 90 CRI / 889lm)	DVG (Dove Gray)		-F (Flush Mount)
	LED1827 ^{1,2} (18W LED / 2700K / 90 CRI / 1265lm)	FLG (Flannel Gray)		
	LED1830 ^{1,2} (18W LED / 3000K / 90 CRI / 1288lm)	GA (Galvanized)		
	LED1835 ^{1,2} (18W LED / 3500K / 90 CRI / 1311lm)	LG (Lime Green)		
	LED1840 ^{1,2} (18W LED / 4000K / 90 CRI / 1334lm)	MB (Matte Black)		
		MBL (Midnight Blue)		
		PNA (Painted Natural Aluminum)		
		PNC (Painted Natural Copper)		
		RD (Red)		
		SGR (Sage Green)		
		SGW (Semi Gloss White)		
		SND (Sand)		
		SS (Satin Silver)		
		TBZ (Textured Bronze)		
		TGP (Textured Graphite)		
		TNG (Tangerine)		
		TTL (Tahitian Teal)		
		WT (Gloss White)		
		YEL (Yellow)		

1. Lamps must be specified, and are not included in shade cost
2. Lumen are raw LED value

KEY: Standard Finishes

ABL (Aegean Blue)	LG (Lime Green)	SGR (Sage Green)
BB (Burnished Bronze)	MB (Matte Black)	SGW (Semi Gloss White)
BK (Gloss Black)	MBL (Midnight Blue)	SND (Sand)
BLU (Blue)	PNA (Painted Natural Aluminum)	SS (Satin Silver)
DVG (Dove Gray)	PNC (Painted Natural Copper)	TBZ (Textured Bronze)
FLG (Flannel Gray)	RD (Red)	TGP (Textured Graphite)

Specialty Finishes

TNG (Tangerine)	GA (Galvanized)
TTL (Tahitian Teal)	
WT (Gloss White)	
YEL (Yellow)	



GLOBE

White Acrylic Globe
with Machined Top Cover

Catalog #:

Project:

Date:

Type:

Notes:

Arm Mount Order Matrix (Example: 2SL23TBZ)

Pipe	Arm Type	Finish	Coastal Coating Option	Input Voltage
2 (1/2" IP)	SL23 (Small Loop - 23")	ABL (Aegean Blue)	(blank) (No coating)	(blank) (120V)
		BB (Burnished Bronze)	-C (Coating)	-27 (277V)
3 (3/4" IP)	SL30 (Small Loop - 30")	BK (Gloss Black)		
		BLU (Blue)		
	LL23 (Large Loop - 23")	DVG (Dove Gray)		
	LL30 (Large Loop - 30")	FLG (Flannel Gray)		
	LC18 (Curve Arm - 18")	GA (Galvanized)		
	LC24 (Curve Arm - 24")	LG (Lime Green)		
	LC30 (Curve Arm - 30")	MB (Matte Black)		
	LM18 (Miter Arm - 18")	MBL (Midnight Blue)		
	LM24 (Miter Arm - 24")	MNA (Painted Natural Aluminum)		
	LM30 (Miter Arm - 30")	PNC (Painted Natural Copper)		
	SA18 (Sign Arm - 18")	RD (Red)		
	SA23 (Sign Arm - 23")	SGR (Sage Green)		
	LSA23 (Large Loop Sign Arm - 23")	SGW (Semi Gloss White)		
	LSA30 (Large Loop Sign Arm - 30")	SND (Sand)		
	A6 (Straight Arm - 6")	SS (Satin Silver)		
	A12 (Straight Arm - 12")	TBZ (Textured Bronze)		
	A18 (Straight Arm - 18")	TGP (Textured Graphite)		
	A24 (Straight Arm - 24")	TNG (Tangerine)		
	A30 (Straight Arm - 30")	TTL (Tahitian Teal)		
	MA18 (Modern Arm - 18")	WT (Gloss White)		
	MA24 (Modern Arm - 24")	YEL (Yellow)		
	MA30 (Modern Arm - 30")			

Standard Finishes

	ABL (Aegean Blue)		RD (Red)
	BB (Burnished Bronze)		SGR (Sage Green)
	BK (Gloss Black)		SGW (Semi Gloss White)
	BLU (Blue)		SND (Sand)
	DVG (Dove Gray)		SS (Satin Silver)
	FLG (Flannel Gray)		TBZ (Textured Bronze)
	LG (Lime Green)		TGP (Textured Graphite)
	MB (Matte Black)		TNG (Tangerine)
	MBL (Midnight Blue)		TTL (Tahitian Teal)
	PNA (Painted Natural Aluminum)		WT (Gloss White)
	PNC (Painted Natural Copper)		YEL (Yellow)

Specialty Finishes

	GA (Galvanized)
--	------------------------

Note: All arm mounts include canopy

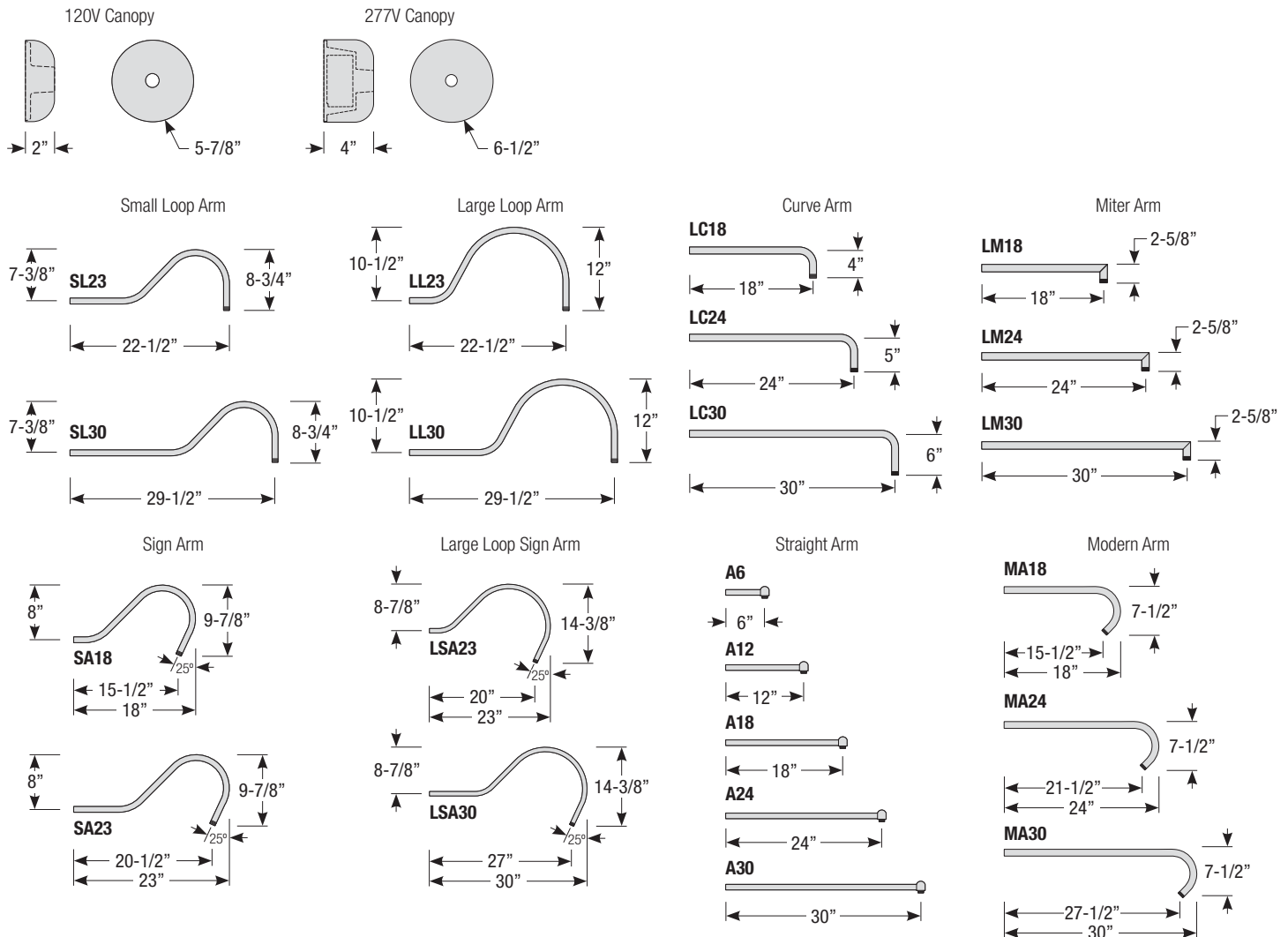

Spec-00030 Revised 09/16/2020



GLOBE

White Acrylic Globe
with Machined Top Cover

Catalog #:

Project:

Type:

Date:

Notes:

Knuckle Accessory Order Matrix (Example: 2KNLTBZ)

Pipe	Finish	Finish	Coastal Coating Option
2 (1/2" IP)	KNL (Adjustable 180° Knuckle for Arm Mounts)	ABL (Aegean Blue)	(blank) (No coating)
3 (3/4" IP)		BB (Burnished Bronze)	-C (Coating)
		BK (Gloss Black)	
		BLU (Blue)	
		DVG (Dove Gray)	
		FLG (Flannel Gray)	
		GA (Galvanized)	
		LG (Lime Green)	
		MB (Matte Black)	
		MBL (Midnight Blue)	
		PNA (Painted Natural Aluminum)	
		PNC (Painted Natural Copper)	
		RD (Red)	
		SGR (Sage Green)	
		SGW (Semi Gloss White)	
		SND (Sand)	
		SS (Satin Silver)	
		TBZ (Textured Bronze)	
		TGP (Textured Graphite)	
		TNG (Tangerine)	
		TTL (Tahitian Teal)	
		WT (Gloss White)	
		YEL (Yellow)	

Description

Adjustable knuckle for arm mounts that allow luminaire to be rotated up to 180°.

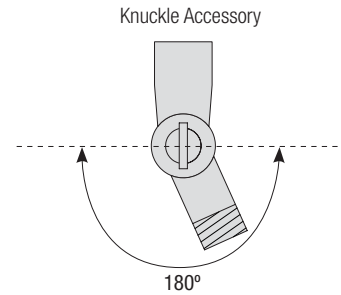

KEY: Standard Finishes

ABL (Aegean Blue)	LG (Lime Green)	SGR (Sage Green)
BB (Burnished Bronze)	MB (Matte Black)	SGW (Semi Gloss White)
BK (Gloss Black)	MBL (Midnight Blue)	SND (Sand)
BLU (Blue)	PNA (Painted Natural Aluminum)	SS (Satin Silver)
DVG (Dove Gray)	PNC (Painted Natural Copper)	TBZ (Textured Bronze)
FLG (Flannel Gray)	RD (Red)	TGP (Textured Graphite)

Specialty Finishes

TNG (Tangerine)	GA (Galvanized)
TTL (Tahitian Teal)	
WT (Gloss White)	
YEL (Yellow)	

GLOBE

White Acrylic Globe
with Machined Top Cover

Catalog #:

Project:

Date:

Type:

Notes:

Post / Wall Mount Order Matrix (Example: 2P1TBZ)

Pipe	Mount Type	Finish	Input Voltage
2 (1/2" IP)	P1 (Single Post Mount) P2 (Double Post Mount) W1 (Traditional Wall Mount)	ABL (Aegean Blue)	(blank) (120V)
		BB (Burnished Bronze)	-27 ³ (277V)
		BK (Gloss Black)	
		BLU (Blue)	
		DVG (Dove Gray)	
		FLG (Flannel Gray)	
		GA (Galvanized)	
		LG (Lime Green)	
		MB (Matte Black)	
		MBL (Midnight Blue)	
		PNA (Painted Natural Aluminum)	
		PNC (Painted Natural Copper)	
		RD (Red)	
SGR (Sage Green)			
SGW (Semi Gloss White)			
SND (Sand)			
SS (Satin Silver)			
TBZ (Textured Bronze)			
TGP (Textured Graphite)			
TNG (Tangerine)			
TTL (Tahitian Teal)			
WT (Gloss White)			
YEL (Yellow)			

3. Post mount only

Post Type Order Matrix (Example: P8683-96TBZ)

Post Type	Finish
PM4946 (Cast Aluminum Post)	ABL (Aegean Blue)
P8683-96 (Cast Aluminum Base w/ 96" Aluminum Post)	BB (Burnished Bronze)
P8683-120 (Cast Aluminum Base w/ 120" Aluminum Post)	BK (Gloss Black)
P8684-96 (96" Straight Aluminum Post)	BLU (Blue)
P8684-120 (120" Straight Aluminum Post)	DVG (Dove Gray)
PM8685 (Cast Aluminum Pier Mount - must be used with straight aluminum post, P8684)	FLG (Flannel Gray)
	GA (Galvanized)
	LG (Lime Green)
	MB (Matte Black)
	MBL (Midnight Blue)
	PNA (Painted Natural Aluminum)
	PNC (Painted Natural Copper)
	RD (Red)
	SGR (Sage Green)
	SGW (Semi Gloss White)
	SND (Sand)
	SS (Satin Silver)
	TBZ (Textured Bronze)
	TGP (Textured Graphite)
	TNG (Tangerine)
	TTL (Tahitian Teal)
	WT (Gloss White)
	YEL (Yellow)

Standard Finishes

 ABL (Aegean Blue)	 RD (Red)
 BB (Burnished Bronze)	 SGR (Sage Green)
 BK (Gloss Black)	 SGW (Semi Gloss White)
 BLU (Blue)	 SND (Sand)
 DVG (Dove Gray)	 SS (Satin Silver)
 FLG (Flannel Gray)	 TBZ (Textured Bronze)
 LG (Lime Green)	 TGP (Textured Graphite)
 MB (Matte Black)	 TNG (Tangerine)
 MBL (Midnight Blue)	 TTL (Tahitian Teal)
 PNA (Painted Natural Aluminum)	 WT (Gloss White)
 PNC (Painted Natural Copper)	 YEL (Yellow)

Specialty Finishes

 GA (Galvanized)
--

Single Post Mount

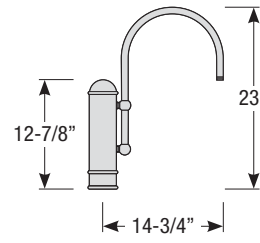

Double Post Mount

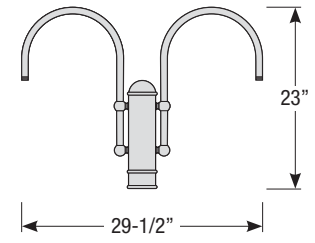

Traditional Wall Mount

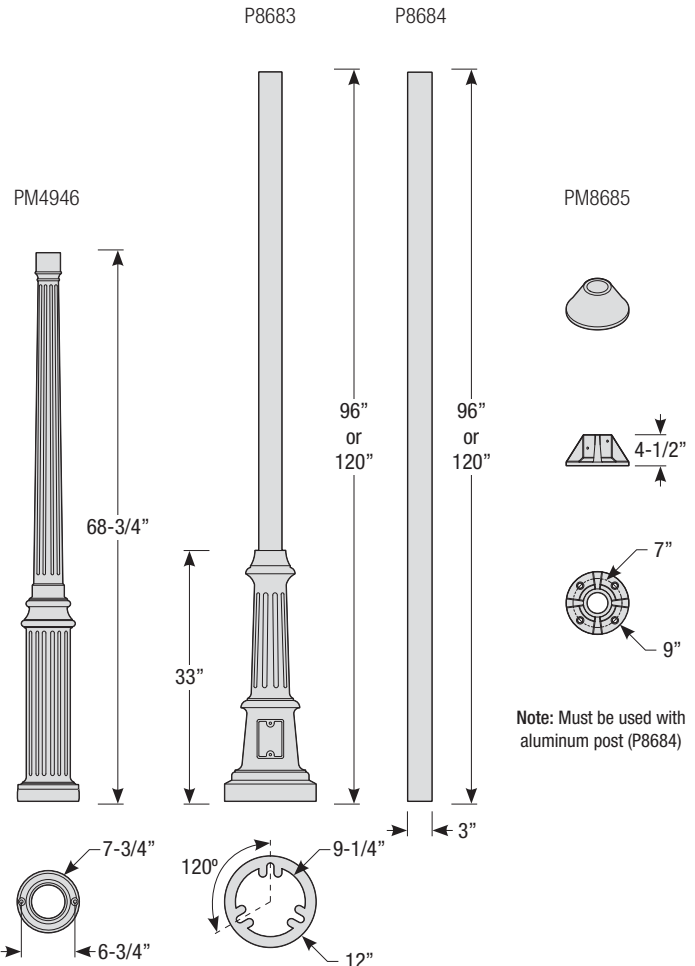
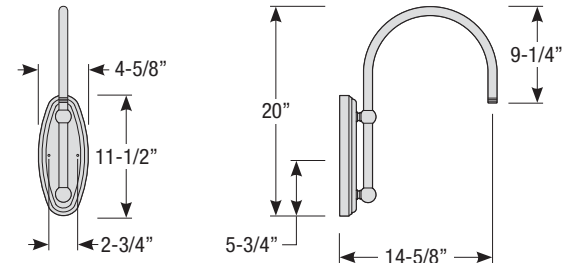

Note: Must be used with aluminum post (P8684)

Spec-00030 Revised 09/16/2020

14508 Nelson Ave. City of Industry, CA 91744 • tel: 626.336.4511 • fax: 626.330.4266 • www.TroyRLM.com
©2020 Troy-RLM Lighting, A Division of Troy-CSL Lighting, Inc. All rights reserved. Subject to change without notice.



GLOBE

White Acrylic Globe
with Machined Top Cover

Catalog #:

Project:

Date:

Type:

Notes:

Stem Mount Order Matrix (Example: 2HS36TBZ)

Pipe	Stem Length	Finish	Coastal Coating Option
2 (1/2" IP)	HS12 (12")	ABL (Aegean Blue)	(blank) (No coating)
	HS18 (18")	BB (Burnished Bronze)	-C (Coating)
	HS24 (24")	BK (Gloss Black)	
	HS36 (36")	BLU (Blue)	
	HS48 (48")	DVG (Dove Gray)	
	HS__ (Custom length from 2" up to 60")	FLG (Flannel Gray)	
		GA (Galvanized)	
		LG (Lime Green)	
		MB (Matte Black)	
		MBL (Midnight Blue)	
		PNA (Painted Natural Aluminum)	
		PNC (Painted Natural Copper)	
		RD (Red)	
		SGR (Sage Green)	
	SGW (Semi Gloss White)		
	SND (Sand)		
	SS (Satin Silver)		
	TBZ (Textured Bronze)		
	TGP (Textured Graphite)		
	TNG (Tangerine)		
	TTL (Tahitian Teal)		
	WT (Gloss White)		
	YEL (Yellow)		

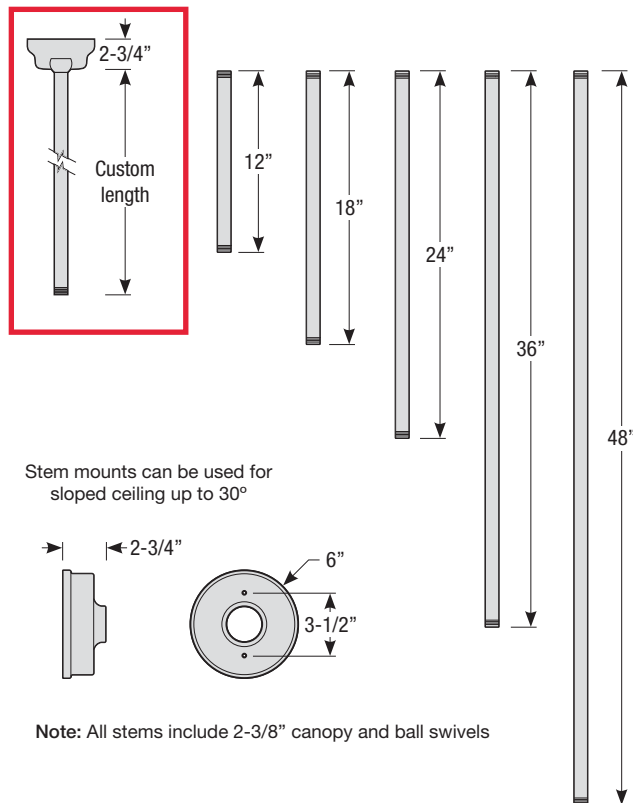

custom stem length to match historic photos

KEY: Standard Finishes

ABL (Aegean Blue)	LG (Lime Green)	SGR (Sage Green)
BB (Burnished Bronze)	MB (Matte Black)	SGW (Semi Gloss White)
BK (Gloss Black)	MBL (Midnight Blue)	SND (Sand)
BLU (Blue)	PNA (Painted Natural Aluminum)	SS (Satin Silver)
DVG (Dove Gray)	PNC (Painted Natural Copper)	TBZ (Textured Bronze)
FLG (Flannel Gray)	RD (Red)	TGP (Textured Graphite)

Specialty Finishes

TNG (Tangerine)	GA (Galvanized)
TTL (Tahitian Teal)	
WT (Gloss White)	
YEL (Yellow)	

Ceiling Flush Mount Canopy

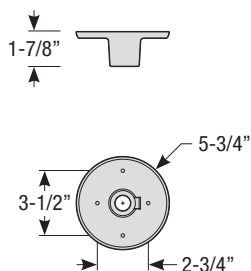

Note: Ceiling flush mount canopy includes 2" stem

Pendant Canopy

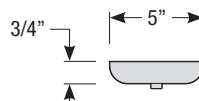

Features

- Black Composite Housing
- Chip and Fade Resistant Construction
- Clear Prism or White Smooth Acrylic 8" Globe
- Short & Long Tail are included
- Wall Mount Only
- Outside Use Only
- LED A19 Ready (*Bulb Not Included*)
- Made in America Compliant
- Standard Packaging: 1

Applications

- Wall Mount
- Outdoor Use Only

Wattage/Lumens

E26 Medium Base Systems (LED A19 Ready)

- Medium E26 Base (*75W Max*) (*Bulb Not Included*)

Warranty

- 3-Year Medium Base



Options

PE - Photocell (120V)^{IV}

Dimensions

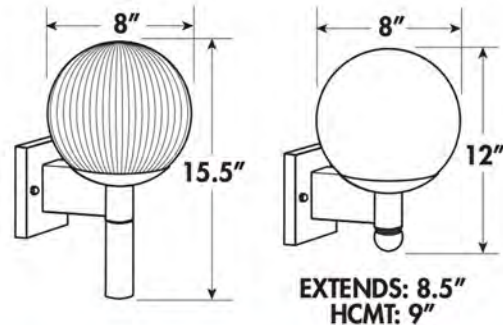

ORDERING GUIDE

Example: 38895-E26

Family	Lens Color	Base Color	Wattage	CCT	Options
388	1 - White 9 - Clear Prism	5 - Black	E26 - Medium Base		PE - Photocell (120V) ^{IV}
		Special Finishes** 1 - White ^{IV} 			

Sources

1. Postcard - Front
<https://www.flickr.com/photos/wguru/4374353512/>
2. Flyer
<https://content-static.detroitnews.com/projects/detroit-underground-key-scenes/embed.html>
3. 1971 - Stanleys Mannia Cafe - Opening
<https://www.flickr.com/photos/wguru/albums/72157644099833625>
4. The Rhythm Kitchen Flyer
<http://bunyan Chopshop.blogspot.com/2008/01/rhythm-kitchen-flyer.html>
5. Video Still, Eminem at The Rhythm Kitchen
<https://southpawer.com/2020/04/30/eminem-booed-off-stage-rare/>
6. Sean “Puffy” Combs, Aaliya, and Biggie Smalls
<https://www.musicorigins.org/item/the-hip-hop-shop/>
7. Dean Van Nguyen, “ The Story of Phat Kat, ‘Carte Blanche,’ and the Gods of Detroit Hip-Hop”
<https://daily.bandcamp.com/features/phat-kat-feature>
8. Grace Fellowship Baptist Church
<https://www.flickr.com/photos/83025347@N00/250123945/>
9. Opening Night Newspaper Ad
<https://www.newspapers.com/clip/7445476/opening-night-stanleys-mania-cafe/>
10. Grace Fellowship Baptist Church
<https://johnnatiwjournal.files.wordpress.com/2013/12/stanleyschurch.jpg>
11. Nathan Johnson, 1991
<https://outlet.historicimages.com/products/dfpy72065>
12. Nathan Johnson, 2019
<https://www.detroitnews.com/story/entertainment/2019/10/08/detroit-black-architects-tour-nathan-johnson-docomomo/3908522002/>
13. Bethel AME Church
https://www.infinitemiledetroit.com/30_MODERNIST_CHURCHES_03_48202.html
14. Hong Residence
<https://twitter.com/joshlipnik/status/1268342047259361280>
15. Thunderbird Inn
<https://archive.lib.msu.edu/MMM/JR/02/b/JR02b021.jpg>
16. Second Baptist Church Addition, People Mover Station in Downtown Detroit
<https://floydhome.com/blogs/livedin/nathan-johnson-space-age-style>
17. Norm’s Diner by Louis Armet & Eldon Davis. Los Angeles, CA
<https://www.lamag.com/digestblog/norms-70-breakfast/>
18. Pann’s by Eldon Davis & Helen Liu Fong. Los Angeles, CA
<https://www.flickr.com/photos/wallyg/14646306158>
19. La Concha Motel Lobby by Paul Williams. Las Vegas, Nevada
<https://traveltalkcafe.com/reviews/attractions/the-neon-museum-in-las-vegas-nevada/>
20. Oldest MacDonald’s by Stanley Clark Meston. Los Angeles, CA
<https://www.architecturaldigest.com/gallery/googie-buildings-la>
21. CaixaForum by Herzog & de Meuron. Madrid, Spain.
<https://architizer.com/projects/caixaforum/>
22. St. Ann’s Warehouse by Marvel Architects. NYC.
<https://marveldesigns.com/work/st-ann-s-warehouse/110>
23. Motown Museum. Detroit, USA
<https://architectsandartisans.com/the-motown-museum-by-perkins-and-will/>
24. Flax Museum by noArchitecten. Belgium.
<https://afasiaarchzine.com/2017/03/noarchitecten-3/>
25. Rotermann’s Quarter by HGA. Estonia.
<https://www.archdaily.com/330863/rotermanns-old-and-new-flour-storage-hga>
26. Moritzburg Museum by Nieto Sobejano Arquitectos. Germany.
<https://www.archdaily.com/132838/moritzburg-museum-extension-nieto-sobejano-arquitectos>
27. Historic Detroit - Stanley Hong’s Mannia Cafe
<https://historicdetroit.org/buildings/stanley-hong-s-mannia-cafe>
28. Denim’s Master Designer
<https://mauricemaloneusa.com/pages/about-fashions-best-denim-designer>
29. Designing the Future, The Legacy of Black Architects in Detroit
<https://detroit.curbed.com/2019/7/15/20695147/black-architects-detroit-sims-varner-charlewright>
30. Googie, Architecture of the Space Age
<https://www.smithsonianmag.com/history/googie-architecture-of-the-space-age-122837470/>
31. Maurice Malone
<https://respect-mag.com/2020/02/maurice-malone-black-history-month-design-scholarship/>
32. Architecture / Detroit
<https://esotericsurvey.blogspot.com/2015/08/architecture-detroit.html>
33. Nathan Johnson, Stanley’s Mannia cafe (1968) Detroit, MI
<https://twitter.com/JoshLipnik/status/1268334515501629440/photo/2>
34. Johnson’s Original Design of Bethel AME Church
<https://www.detroitnews.com/story/entertainment/2019/10/08/detroit-black-architects-tour-nathan-johnson-docomomo/3908522002/>

