

# Regency

65, 66, 67, 68, 69, 70, 71, 72, 73, 74, 270, 271



Safe-Way Model 65



Safe-Way Model 70 in Driftwood

## Elegance and Performance

Enhance the appearance of your home with Regency Series by Safe-Way Door. These handsome residential garage doors combine the beauty of wood-like design with the strength and easy care of steel. Available with a variety of panel styles, the Regency Series features insulation surrounded by two steel skins, thus providing durability and noise reduction. A choice of window styles and durable baked factory finishes lets you select the perfect door for your home.

*Make a Statement.*



# Regency

Models 65, 66, 67, 68, 69, 70, 71, 72, 73, 74, 270, 271



## AVAILABLE COLORS

Models 70, 71, 72, 73, 74, 271



Models 65, 66, 67, 68, 69, 270

Safe-Way Model 68

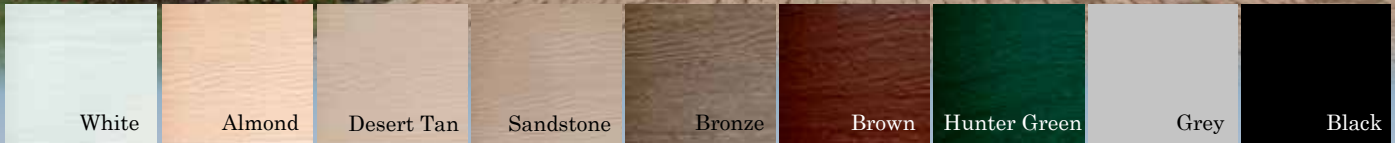

## DECORATIVE HARDWARE

### Hinges

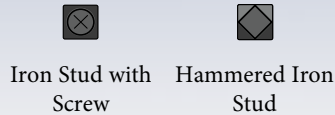
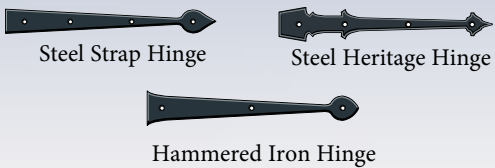

### Handles

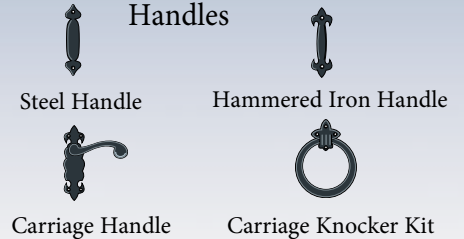

## AVAILABLE PANEL STYLES



Standard // Model 65, 70



Medium // Model 69, 71



Ranch // Model 67, 72



Flush // Model 66, 74



Stamped Carriage Short // Model 68, 73



Micro Ribbed // Model 270, 271

## ESTATE WINDOW SERIES

Model 65, 66, 68, 70, 73, 74, 270, 271 | **Standard** | **Raised Panel**

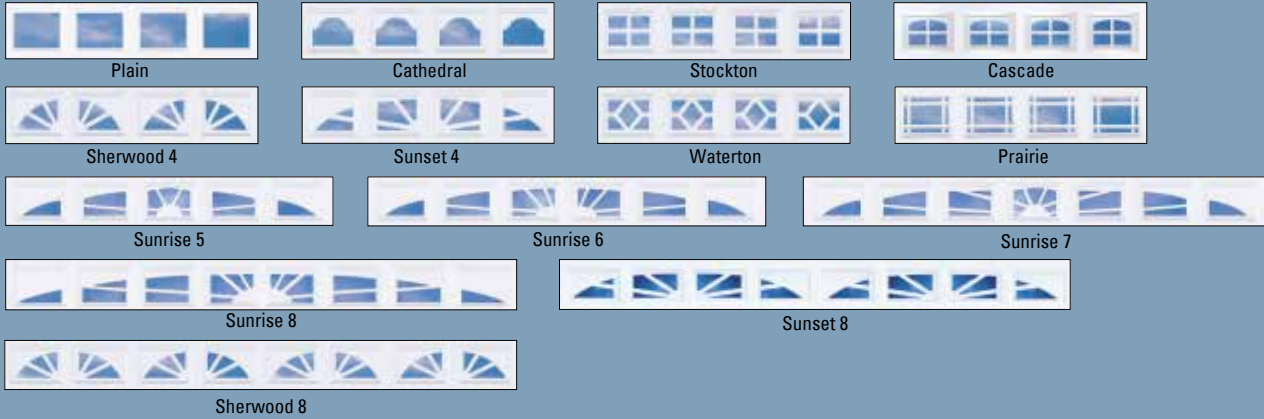

Model 69, 71, 270, 271 | **Medium** | **Raised Panel**



Model 66, 67, 68, 72, 74, 270, 271 | **Long Ranch** | **Raised Panel**

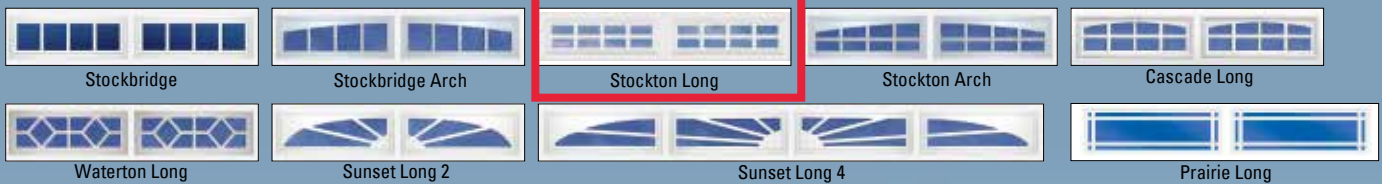

## GENTRY WINDOW SERIES\*

Model 65, 66, 68, 70, 73, 74, 270, 271 | **Standard** | **Raised Panel**

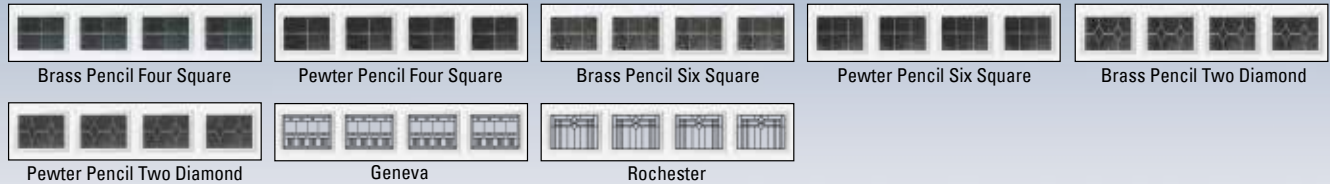

Model 69, 71, 270, 271 | **Medium** | **Raised Panel**

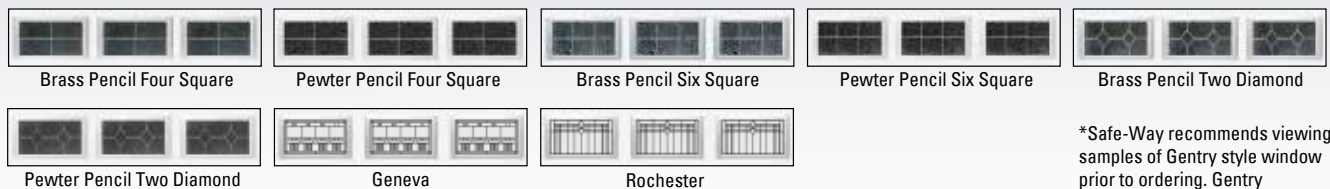

Model 66, 67, 68, 72, 73, 74, 270, 271 | **Long Ranch** | **Raised Panel**

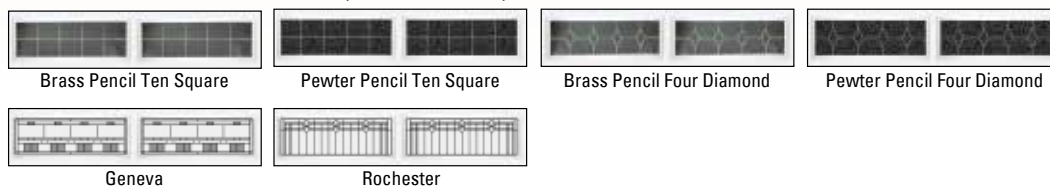

\*Safe-Way recommends viewing samples of Gentry style window prior to ordering. Gentry depictions on this literature are actual photography however lighting inside or outside the garage can significantly impact the "look" of these windows. Please consult with your dealer prior to purchase.

## CONSTRUCTION

Two deep-drawn, tension-leveled, galvanized steel skins are polyester painted and wrapped around a one-pound density expanded polystyrene insulation board using a polyurethane adhesive.

This construction method provides insulation value, durability, sound deadening qualities, and dent resistance for an all-around superior product.

- A. Finish Painted Coat
- B. Primer Coat
- C. Galvanized Layer
- D. Steel

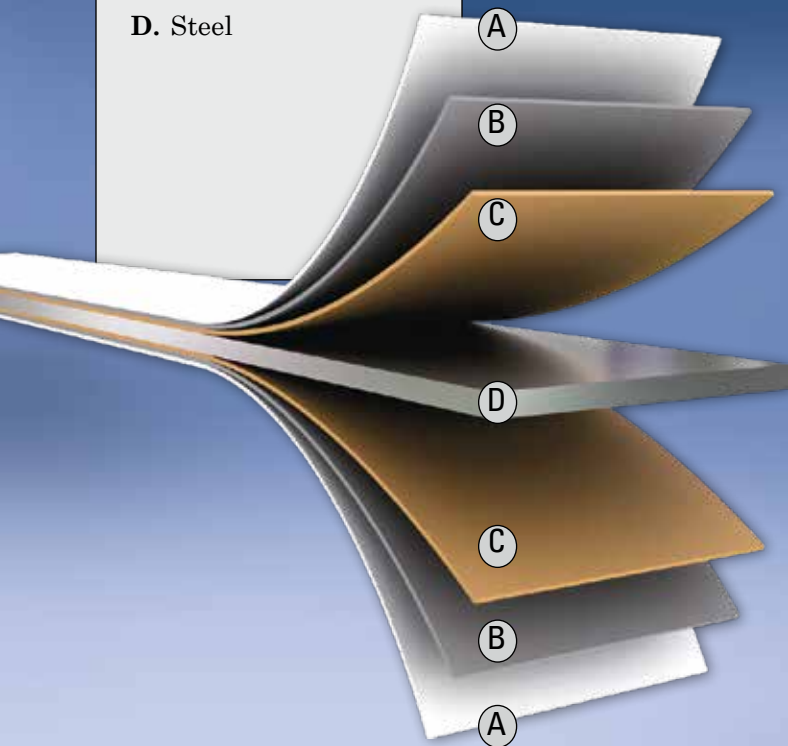

- A. 11 ball nylon rollers provide quiet operation and long lasting durability.
- B. Heavy duty galvanized 14 gauge hardware.
- C. Tongue and groove design provides weathertight section joints.
- D. 2" expanded polystyrene insulation provides an R-Value of 10.25.
- E. Steel skins inside and out provide maximum durability.
- F. Aluminum bottom retainer with vinyl weatherstrip.

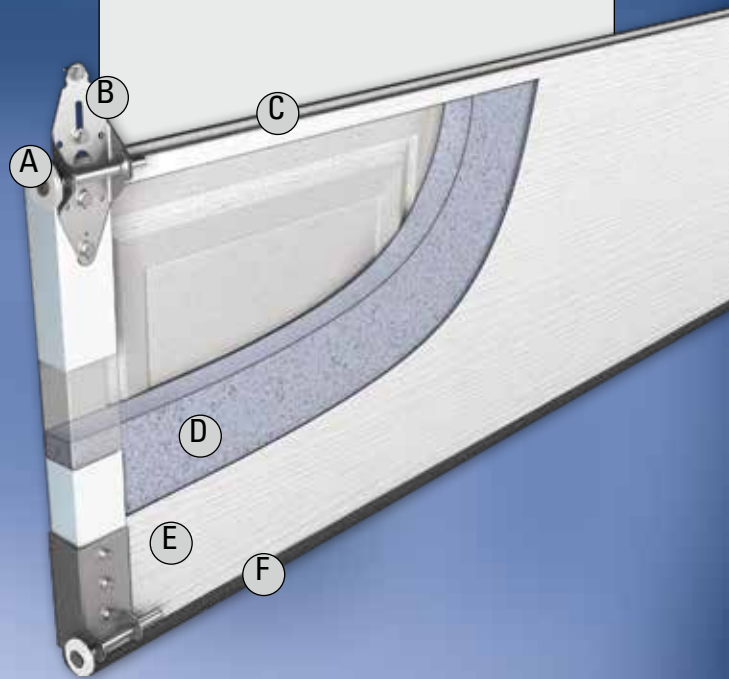

Distributed by:



As Safe-Way Door constantly strives to improve our product, all specifications listed in this informative brochure are subject to change without notice or obligation. Printed color may vary from actual color, please check with your local dealer for color swatches.  
9/18



3814 East U.S. 30 • Warsaw, IN 46580  
574-267-4861 •  
Fax: 574-267-2871  
safewaydoor.com