

Profile / dimension details of the existing windows compared to the proposed new windows

Example of existing 'original' wood window that has been identified for replacement:

- Sash Exterior Material : Wood (painted)
- Sash Interior Material: Wood (painted)
- Dimensions
 - Brick Mold Width: ~ 2 ¼"
 - Sash Stil Width : ~ 1 ⅝"
 - Upper Sash, Top Rail Width: ~ 1 ½"
 - Lower Sash, Bottom Rail Width: ~ 3"



Brick Mold Width



Sash Stil Width



Upper Sash Upper Width



Bottom Sash Bottom Width

New Windows that are proposed to replace existing damaged windows and vinyl windows.

- Pella Architect Series
- Sash Exterior Material :aluminum Clad Wood (factory painted)
 - Proposed color: Black
- Sash Interior Material: Wood (stained)
- Dimensional Information
 - Brick Mold Width: ~ 2"
 - Sash Stile Width: 1 7/16"
 - Upper Sash, Bottom Rail Width: 1 7/16"
 - Lower Sash, Bottom Rail Width: 3"



(Image does not show proposed color)

1/1 double hung



16/1 double hung interior view

Grille Patterns

Grilles give the appearance of individual window panes. Pella offers many grille patterns to help enhance your home's architectural style.



Traditional



This window is customizable in any pattern.

12/1 double hung



Architect Series® Traditional Hung Window

SE Unit Sections - Aluminum-Clad Ogee Exterior Glazing Profile

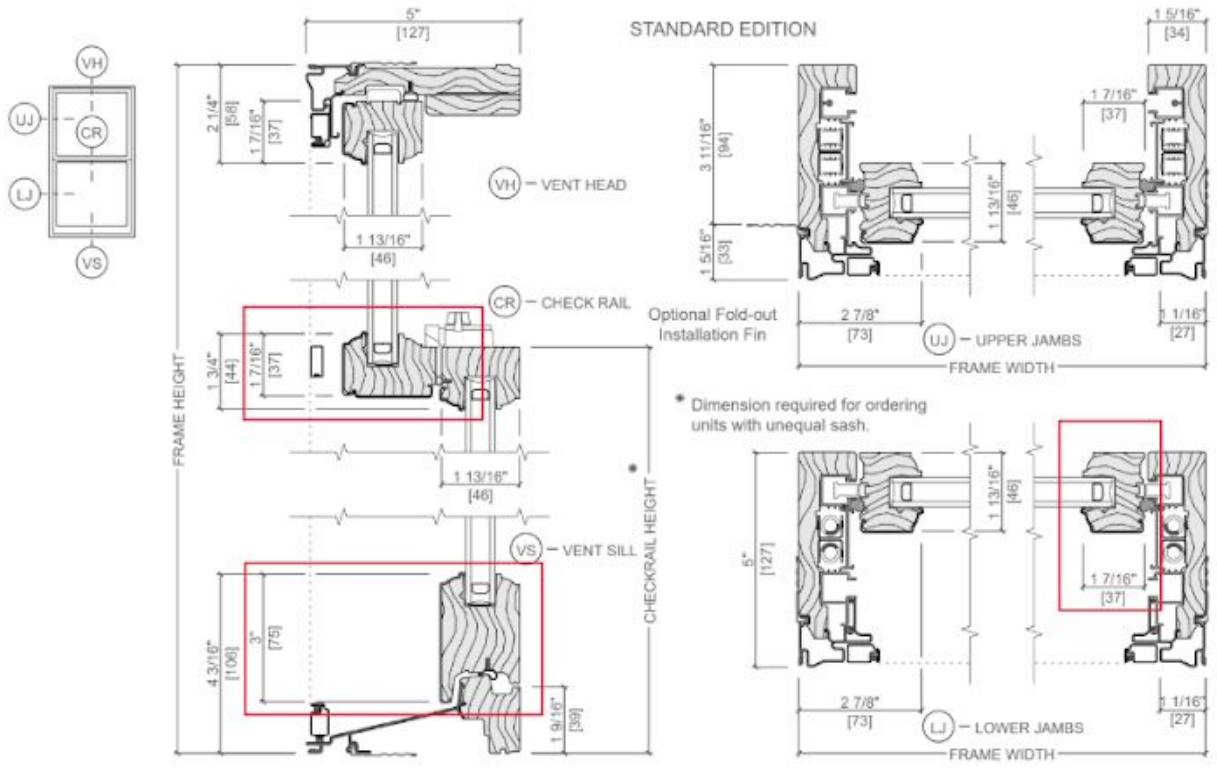

Exterior Window and Door Trim Options

NEW CONSTRUCTION/SPECIAL CONDITIONS

J-CHANNEL

Factory-applied, integral vinyl trim for use with vinyl siding.

✕ WOOD CLAD ✕ FIBERGLASS ✓ VINYL



Pella® 350 Series with J Channel

- Prefinished; matches window frame.
- Vinyl siding can be inserted into the channel.
- Designed for windows only.

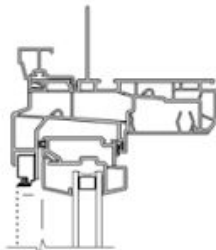

Pella 350 Series

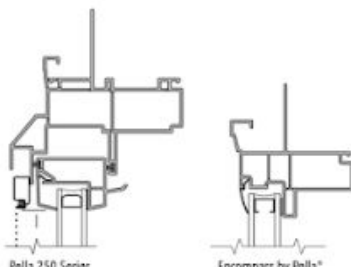

Pella 250 Series

Encompass by Pella®

HEAD DETAIL

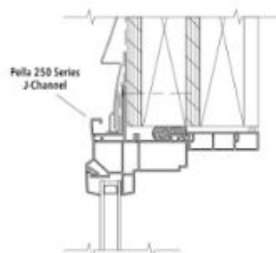

Pella 250 Series J-Channel

TRADITIONAL TRIM

Durable, field-cut aluminum snap-in trim.

✓ WOOD CLAD ✕ FIBERGLASS ✕ VINYL



Brickmould trim with 1/2" Sill Nose

- Prefinished; matches window frame.
- Custom brickmould profiles available.
- 96" or 144" lengths.
- Straight or curved.
- 3" flat or 1-1/2" brickmould.

TRIM PROFILES

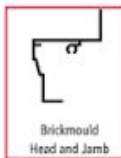

Brickmould Head and Jamb



3-1/2" Flat Trim Head



3-1/2" Flat Trim Jamb

SILL PROFILES



1/2" Sill Nose

HEAD DETAIL

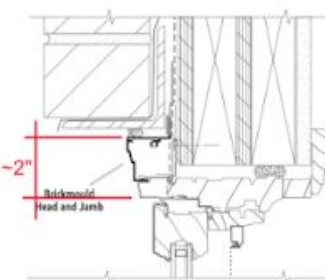

2" Brickmould Head and Jamb

5/8" INTEGRAL FLANGE

Factory applied, integral vinyl flange for use in masonry walls.

✕ WOOD CLAD ✕ FIBERGLASS ✓ VINYL



Pella 250 Series with 5/8" Integral Flange

- Prefinished; matches window frame.
- Use with wood bucks and precast concrete sill in masonry walls.
- Designed for windows only.

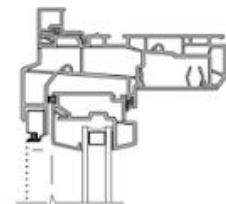

Pella 350 Series

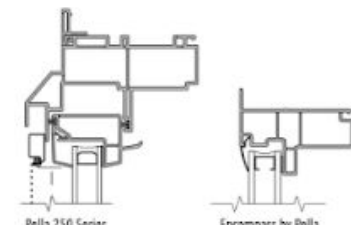

Pella 250 Series

Encompass by Pella

HEAD DETAIL

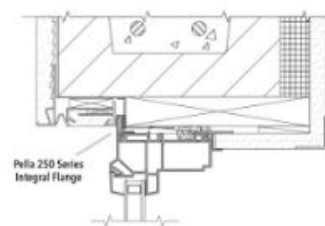

Pella 250 Series Integral Flange

For detailed drawings, visit installation systems on pro.pella.com/install.