

## **Features**

- System depth of 4-1/2" (114.3)
- Available as OX, XO, OXO and OXXO configurations, common mullion allows for additional fixed lites to be stacked (OOX and XOO)
- Infill range from 1/4" (6.4) to 1" (25.4)
- Heavy duty steel ball-bearing, tandem roller assembly
- Stainless steel track insert for sliding panels
- Corrosion-resistant stainless steel locks and fasteners
- Permanodic™ anodized finishes in seven choices
- Painted finishes in standard and custom choices

## **Optional Features**

- Expansion mullion allows for multiple units to be stacked
- Horizontal cross rails available
- Optional interior insect screens available

## **Product Applications**

- The 990 Sliding Door is designed for low to high rise applications for use in condominiums, hotel and apartments

Laws and building and safety codes governing the design and use of glazed entrance, window, and curtain wall products vary widely. Kawneer does not control the selection of product configurations, operating hardware, or glazing materials, and assumes no responsibility therefor.

Kawneer reserves the right to change configuration without prior notice when deemed necessary for product improvement.

© Kawneer Company, Inc., 2010

Laws and building and safety codes governing the design and use of glazed entrance, window, and curtain wall products vary widely. Kawneer does not control the selection of product configurations, operating hardware, or glazing materials, and assumes no responsibility therefor.

Kawneer reserves the right to change configuration without prior notice when deemed necessary for product improvement.  
© Kawneer Company, Inc., 2010

Laws and building and safety codes governing the design and use of glazed entrance, window, and curtain wall products vary widely. Kawneer does not control the selection of product configurations, operating hardware, or glazing materials, and assumes no responsibility therefor.

Kawneer reserves the right to change configuration without prior notice when deemed necessary for product improvement.  
© Kawneer Company, Inc., 2010

**TYPICAL DETAILS ..... 4, 5**  
**SCREEN DETAILS ..... 6**  
**GLAZING OPTIONS ..... 6**  
**HARDWARE OPTIONS ..... 7, 8**  
**WIND LOAD CHARTS..... 9-15**

Metric (SI) conversion figures are included throughout these details for reference. Numbers in parentheses ( ) are millimeters unless otherwise noted.

The following metric (SI ) units are found in these details:

- m – meter
- cm – centimeter
- mm – millimeter
- s – second
- Pa – pascal
- MPa – megapascal

Additional information and CAD details are available at [www.kawneer.com](http://www.kawneer.com)

## TYPICAL ELEVATIONS

ELEVATIONS ARE NUMBER KEYED TO DETAILS ON THE FOLLOWING PAGES

Note: Elevations shown with "Sub-Sash" framing in the fixed lite.

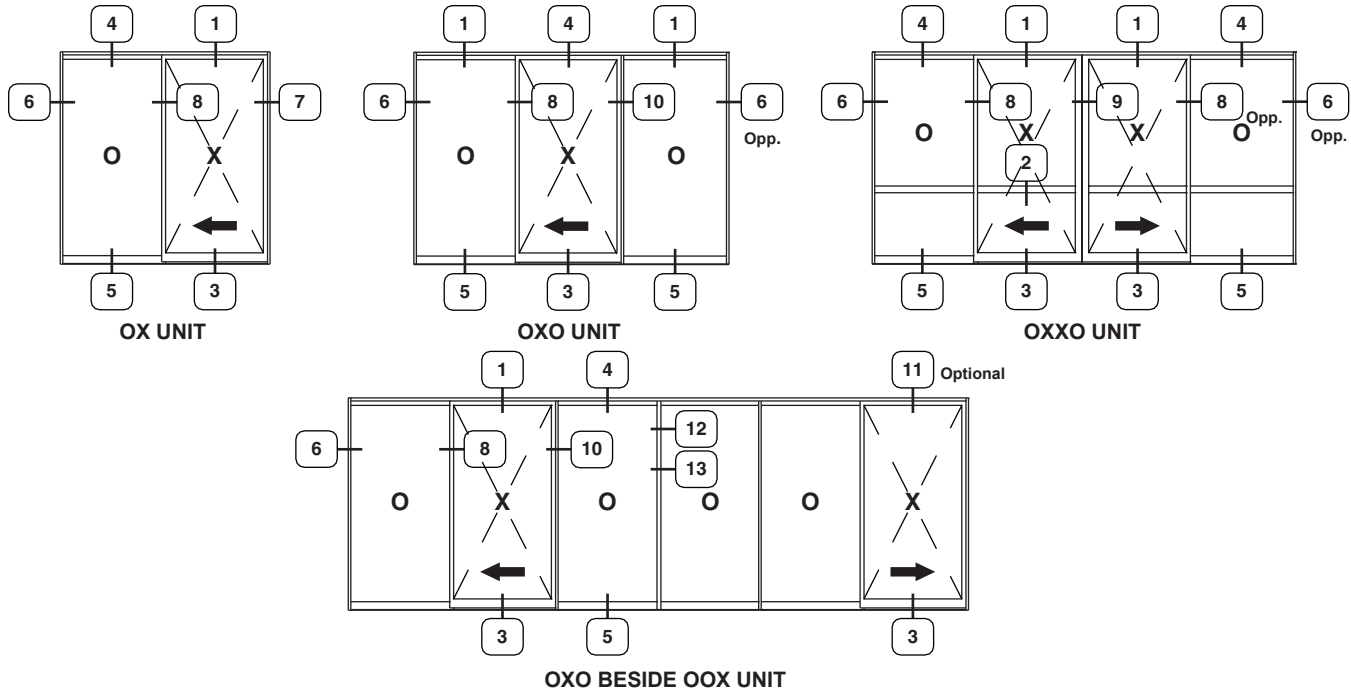

Note: 1/4" infill shown. See Glazing Options for other infills.

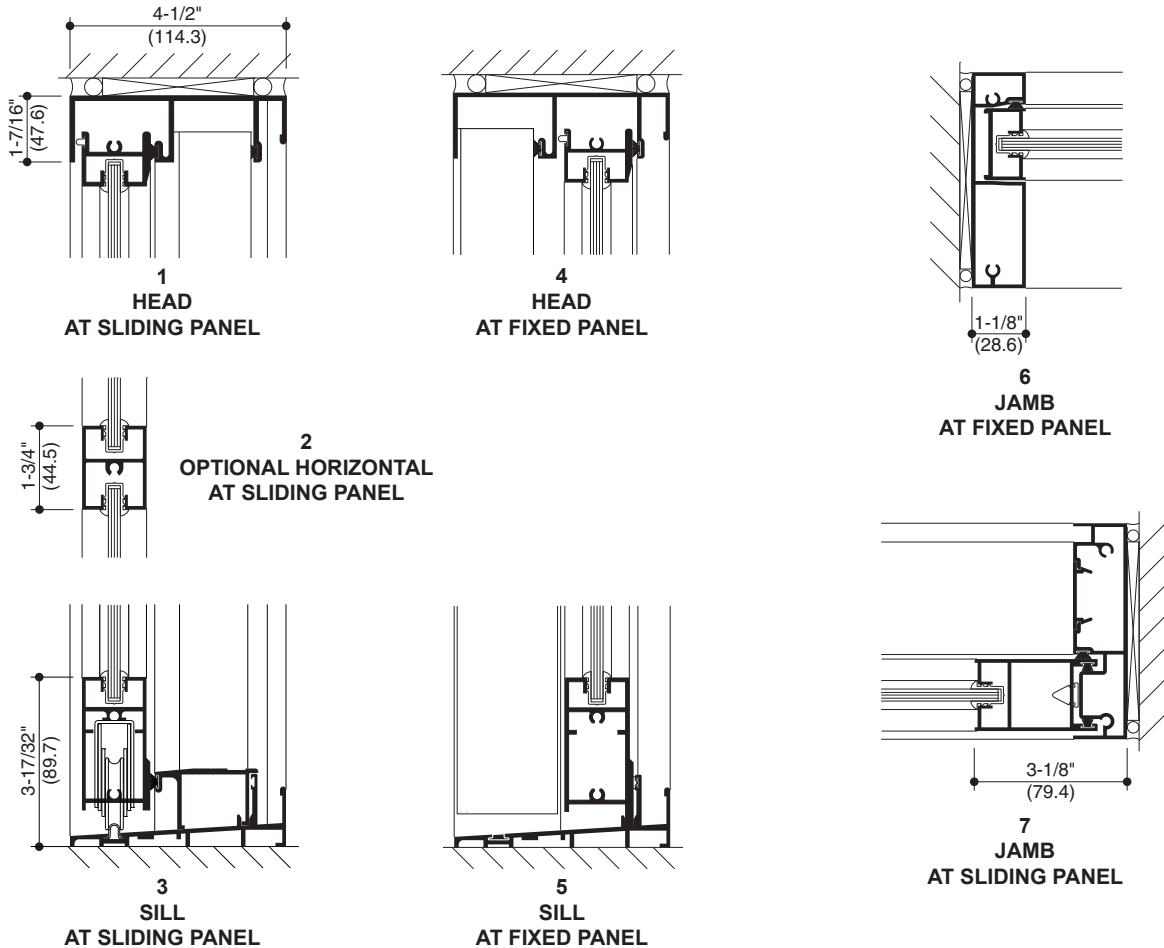

Laws and building and safety codes governing the design and use of glazed entrance, window, and curtain wall products vary widely. Kawneer does not control the selection of product configurations, operating hardware, or glazing materials, and assumes no responsibility therefor.

Kawneer reserves the right to change configuration without prior notice when deemed necessary for product improvement.  
© Kawneer Company, Inc., 2010

Additional information and CAD details are available at [www.kawneer.com](http://www.kawneer.com)

Laws and building and safety codes governing the design and use of glazed entrance, window, and curtain wall products vary widely. Kawneer does not control the selection of product configurations, operating hardware, or glazing materials, and assumes no responsibility therefor.

Kawneer reserves the right to change configuration without prior notice when deemed necessary for product improvement.

© Kawneer Company, Inc., 2010

**8 INTERLOCK STILE**

**9 OXXO MEETING STILES**

**10 LOCK STILE MULLION WITH 1848 LOCK**

**STANDARD RANGE**

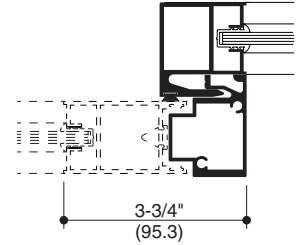
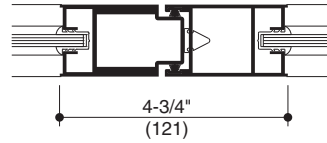
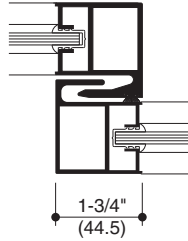

**MID-RANGE**

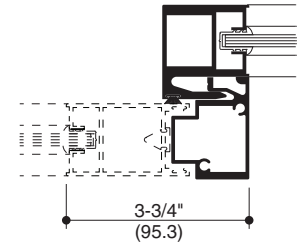
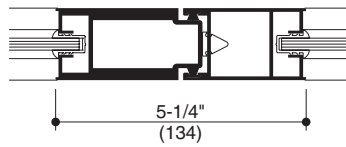
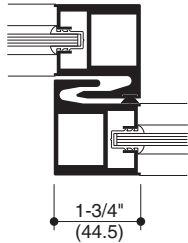

**MAXIMUM RANGE**

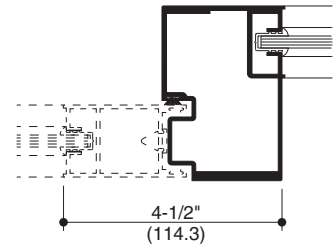
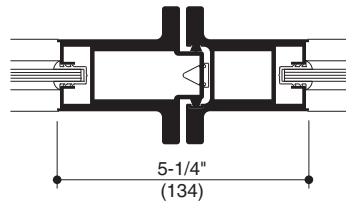
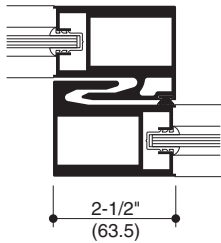

**OPTIONAL MEMBERS**

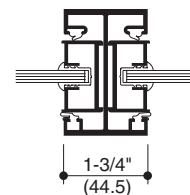
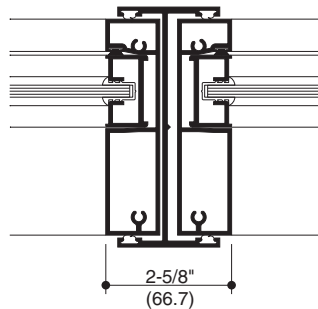
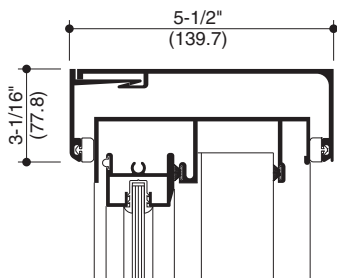

**11 HEAD RECEPTOR (EXTERIOR INSTALLED)**

**12 EXPANSION MULLION**

**13 FIXED STILE MULLION**

Additional information and CAD details are available at [www.kawneer.com](http://www.kawneer.com)

## TYPICAL SCREEN DETAILS

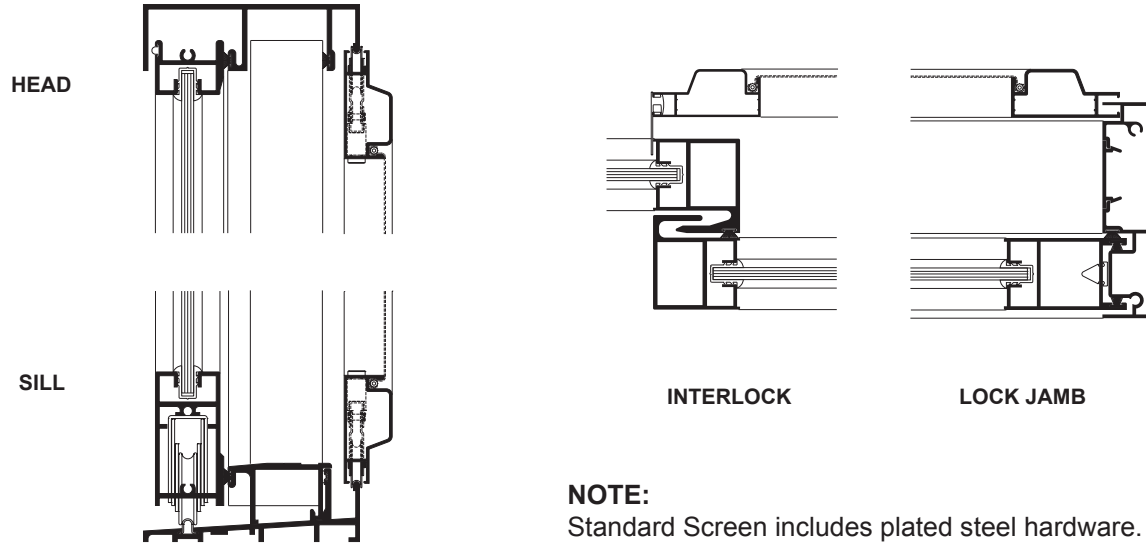

**NOTE:**  
Standard Screen includes plated steel hardware.  
Optional Screen available with stainless steel hardware.

## INFILL OPTIONS

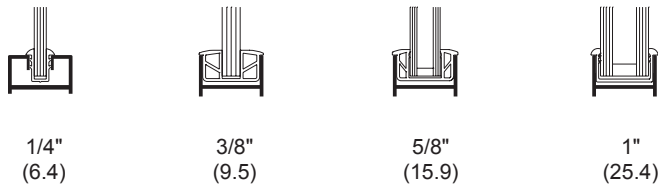

## STANDARD CASTER

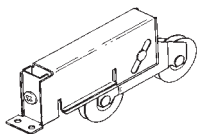





## BUMPER

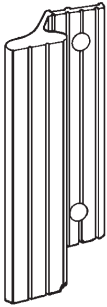
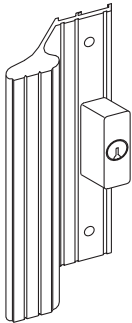
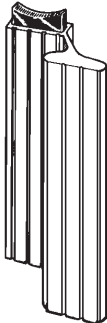
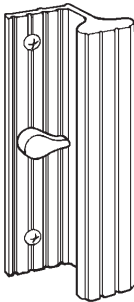

Laws and building and safety codes governing the design and use of glazed entrance, window, and curtain wall products vary widely. Kawneer does not control the selection of product configurations, operating hardware, or glazing materials, and assumes no responsibility therefor.

Kawneer reserves the right to change configuration without prior notice when deemed necessary for product improvement.  
© Kawneer Company, Inc., 2010



1-Point Lock	Handles	Exterior	Option	Interior	Option
	Extruded Pulls	Blank (Std)	1	Slide Operator (Std)	3
		Blank	1	Thumbturn	4
		Basic Cylinder (5/8")	2	Thumbturn	4
	Flush Pulls	Blank	5	Slide Operator	7
		Basic Cylinder (5/8")	6	Slide Operator	7

EXTERIOR HANDLES	INTERIOR HANDLES
<p><b>Extruded Pulls</b></p> <div style="display: flex; justify-content: space-around;"> <div style="text-align: center;">  <p><b>Option 1</b></p> <p>Blank Pull <b>(Standard)</b></p> </div> <div style="text-align: center;">  <p><b>Option 2</b></p> <p>Basic Cylinder (5/8") Pull</p> </div> </div>	<div style="display: flex; justify-content: space-around;"> <div style="text-align: center;">  <p><b>Option 3</b></p> <p>Slide Operator Pull <b>(Standard)</b></p> </div> <div style="text-align: center;">  <p><b>Option 4</b></p> <p>Thumb Pull</p> </div> </div>
<p><b>Flush Pulls</b></p> <div style="display: flex; justify-content: space-around;"> <div style="text-align: center;">  <p><b>Option 5</b></p> <p>Blank Pull</p> </div> <div style="text-align: center;">  <p><b>Option 6</b></p> <p>Basic Cylinder (5/8") Pull</p> </div> </div>	<div style="text-align: center;">  <p><b>Option 7</b></p> <p>Slide Operator Pull</p> </div>

Laws and building and safety codes governing the design and use of glazed entrance, window, and curtain wall products vary widely. Kawneer does not control the selection of product configurations, operating hardware, or glazing materials, and assumes no responsibility therefor.

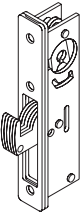
Kawneer reserves the right to change configuration without prior notice when deemed necessary for product improvement.  
© Kawneer Company, Inc., 2010

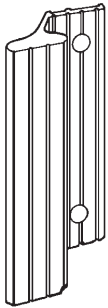
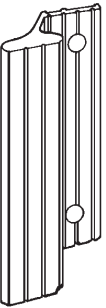
MS Hook Bolt Lock	Handles	Exterior	Option	Interior	Option
	Extruded Pulls	Blank	1	Blank	1
		Mortise Cylinder	9	Mortise Cylinder	9
		Blank	1	Blank	1
		Mortise Cylinder	9	Thumbturn	10
		Blank	1	Blank	1
		---	---	Thumbturn	10
		Blank	1	Blank	1
		---	---	Mortise Cylinder	9
	Flush Pulls	Blank	5	Blank	8
		Mortise Cylinder	9	Mortise Cylinder	9
		Blank	5	Blank	5
		Mortise Cylinder	9	Thumbturn	10
		Blank	5	Blank	5
		---	---	Thumbturn	10
Blank	5	Blank	5		
---	---	Mortise Cylinder	9		

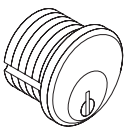
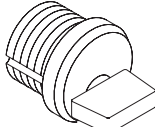
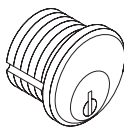
EXTERIOR HANDLES		INTERIOR HANDLES	
<b>Extruded Pulls</b>  Option 1 Blank Pull		 Option 1 Blank Pull	
<b>Flush Pulls</b>  Option 5 Blank Pull		 Option 8 Blank Pull	
<b>EXTERIOR</b>		<b>INTERIOR</b>	
 Option 9 Mortise Cylinder		  Option 10 Thumbturn <span style="margin-left: 100px;">Option 9 Mortise Cylinder</span>	

Laws and building and safety codes governing the design and use of glazed entrance, window, and curtain wall products vary widely. Kawneer does not control the selection of product configurations, operating hardware, or glazing materials, and assumes no responsibility therefor.

Kawneer reserves the right to change configuration without prior notice when deemed necessary for product improvement.  
© Kawneer Company, Inc., 2010



### WIND LOAD CHARTS

Mullions are designed for deflection limitations in accordance with AAMA TIR-A11 of L/175 up to 13'-6" and L/240 +1/4" above 13'-6". These curves are for mullions WITH HORIZONTALS and are based on engineering calculations for stress and deflection. Allowable wind load stress for ALUMINUM 15,152 psi (104MPa), STEEL 30,000 psi (207MPa). Charted curves, in all cases are for the limiting value. Wind load charts contained herein are based upon nominal wind load utilized in allowable stress design. A conversion from Load Resistance Factor Design (LRFD) is provided. To convert ultimate wind loads to nominal loads, multiply ultimate wind loads by a factor of 0.6 per ASCE/SEI 7. A 4/3 increase in allowable stress has not been used to develop these curves. For special situations not covered by these curves, contact your Kawneer representative for additional information.

Laws and building and safety codes governing the design and use of glazed entrance, window, and curtain wall products vary widely. Kawneer does not control the selection of product configurations, operating hardware, or glazing materials, and assumes no responsibility therefor.

Kawneer reserves the right to change configuration without prior notice when deemed necessary for product improvement.  
© Kawneer Company, Inc., 2010

	Allowable Stress Design Load	LRFD Ultimate Design Load
A =	20 PSF (960)	33 PSF (1580)
B =	25 PSF (1200)	42 PSF (2000)
C =	30 PSF (1440)	50 PSF (2400)
D =	40 PSF (1920)	67 PSF (3200)
E =	50 PSF (2400)	83 PSF (4000)

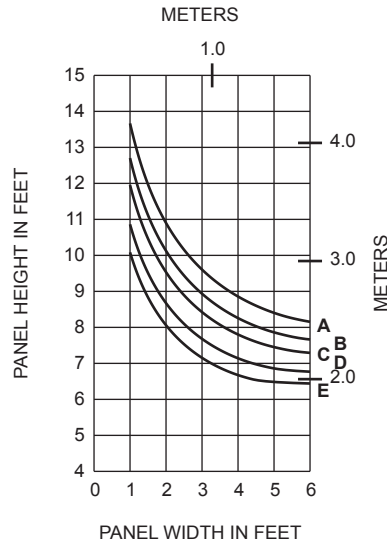
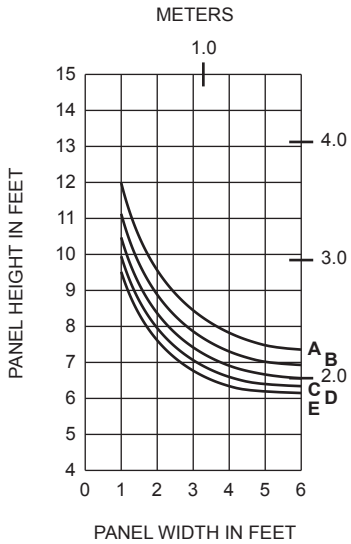
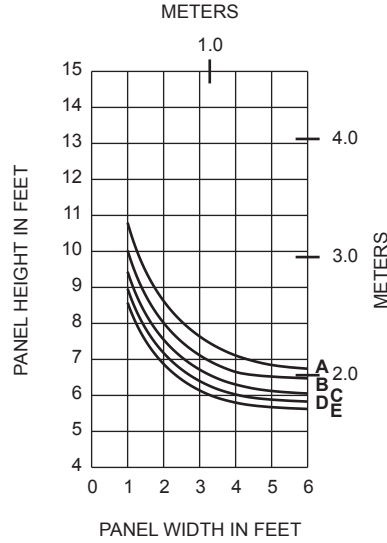

Laws and building and safety codes governing the design and use of glazed entrance, window, and curtain wall products vary widely. Kawneer does not control the selection of product configurations, operating hardware, or glazing materials, and assumes no responsibility therefor.

Kawneer reserves the right to change configuration without prior notice when deemed necessary for product improvement.  
© Kawneer Company, Inc., 2010

## WIND LOAD CHARTS (1/4" INFILL)

	Allowable Stress Design Load	LRFD Ultimate Design Load
<b>A =</b>	<b>20 PSF (960)</b>	<b>33 PSF (1580)</b>
<b>B =</b>	<b>25 PSF (1200)</b>	<b>42 PSF (2000)</b>
<b>C =</b>	<b>30 PSF (1440)</b>	<b>50 PSF (2400)</b>
<b>D =</b>	<b>40 PSF (1920)</b>	<b>67 PSF (3200)</b>
<b>E =</b>	<b>50 PSF (2400)</b>	<b>83 PSF (4000)</b>

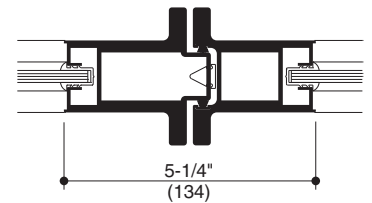
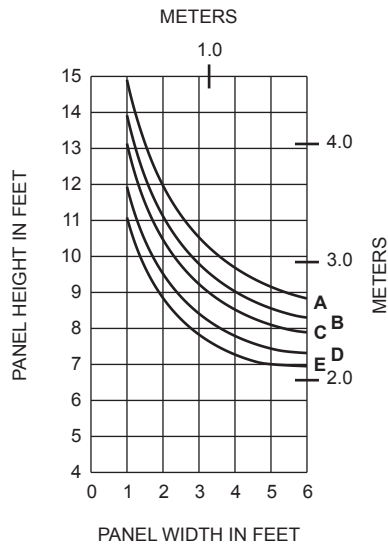
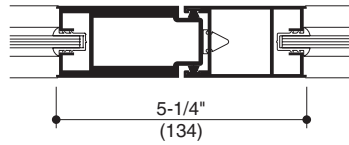
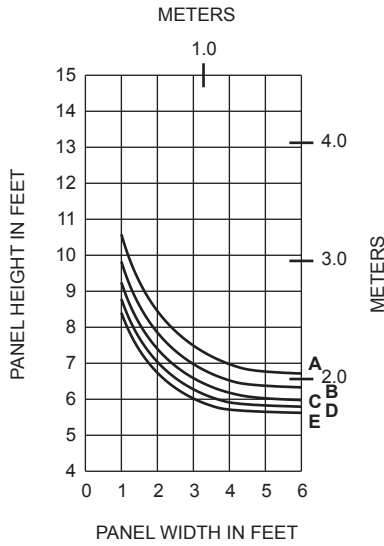
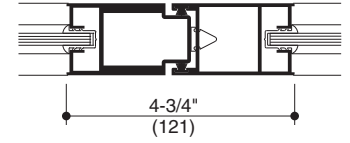
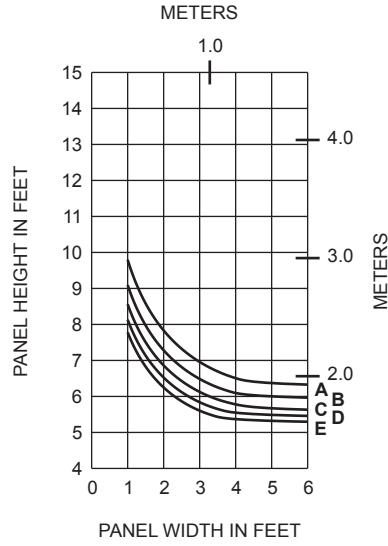

Laws and building and safety codes governing the design and use of glazed entrance, window, and curtain wall products vary widely. Kawneer does not control the selection of product configurations, operating hardware, or glazing materials, and assumes no responsibility therefor.

Kawneer reserves the right to change configuration without prior notice when deemed necessary for product improvement.  
© Kawneer Company, Inc., 2010

	Allowable Stress Design Load	LRFD Ultimate Design Load
A =	20 PSF (960)	33 PSF (1580)
B =	25 PSF (1200)	42 PSF (2000)
C =	30 PSF (1440)	50 PSF (2400)
D =	40 PSF (1920)	67 PSF (3200)
E =	50 PSF (2400)	83 PSF (4000)

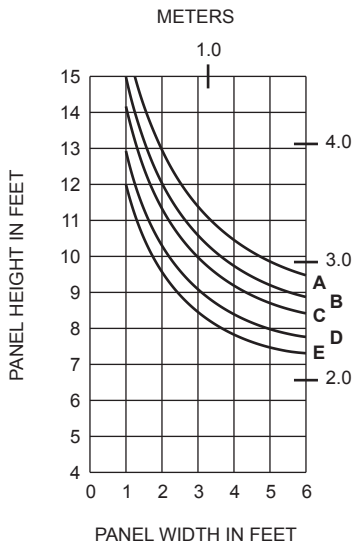
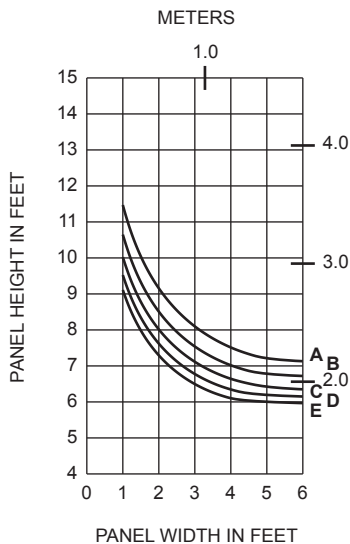
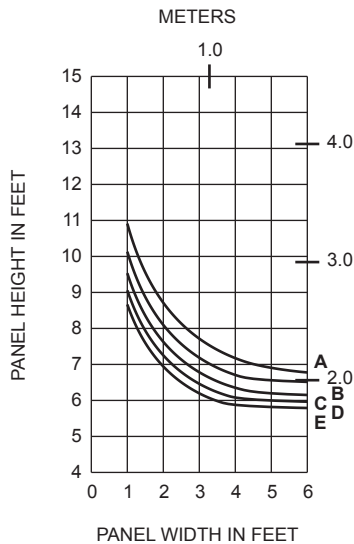

Laws and building and safety codes governing the design and use of glazed entrance, window, and curtain wall products vary widely. Kawneer does not control the selection of product configurations, operating hardware, or glazing materials, and assumes no responsibility therefor.

Kawneer reserves the right to change configuration without prior notice when deemed necessary for product improvement.

© Kawneer Company, Inc., 2010

	Allowable Stress Design Load	LRFD Ultimate Design Load
<b>A =</b>	<b>20 PSF (960)</b>	<b>33 PSF (1580)</b>
<b>B =</b>	<b>25 PSF (1200)</b>	<b>42 PSF (2000)</b>
<b>C =</b>	<b>30 PSF (1440)</b>	<b>50 PSF (2400)</b>
<b>D =</b>	<b>40 PSF (1920)</b>	<b>67 PSF (3200)</b>
<b>E =</b>	<b>50 PSF (2400)</b>	<b>83 PSF (4000)</b>

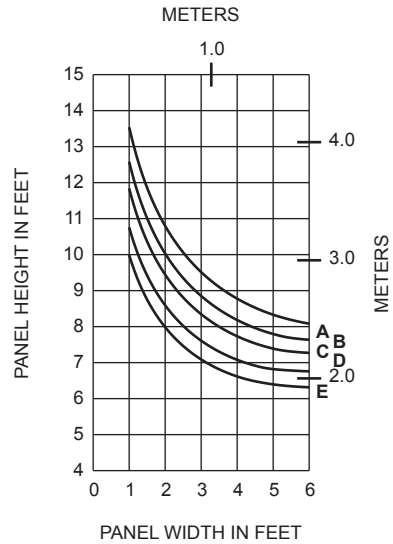
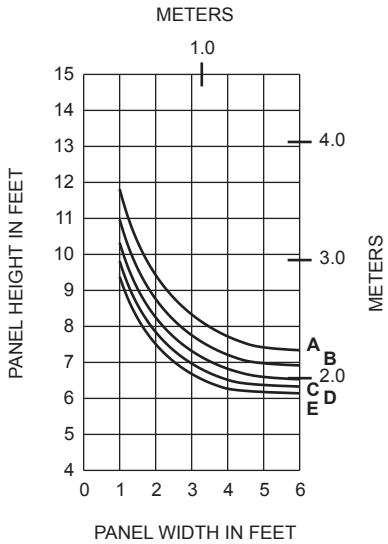
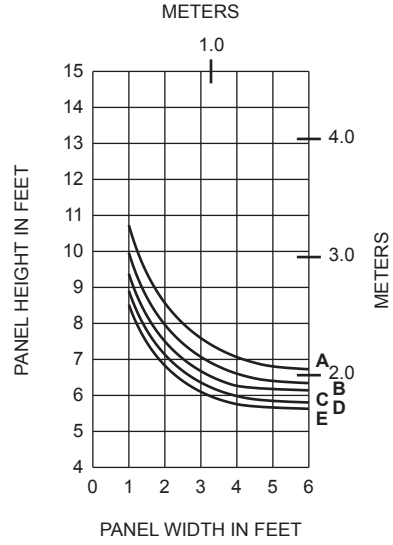

Laws and building and safety codes governing the design and use of glazed entrance, window, and curtain wall products vary widely. Kawneer does not control the selection of product configurations, operating hardware, or glazing materials, and assumes no responsibility therefor.

Kawneer reserves the right to change configuration without prior notice when deemed necessary for product improvement.  
© Kawneer Company, Inc., 2010

	Allowable Stress Design Load	LRFD Ultimate Design Load
A =	20 PSF (960)	33 PSF (1580)
B =	25 PSF (1200)	42 PSF (2000)
C =	30 PSF (1440)	50 PSF (2400)
D =	40 PSF (1920)	67 PSF (3200)
E =	50 PSF (2400)	83 PSF (4000)

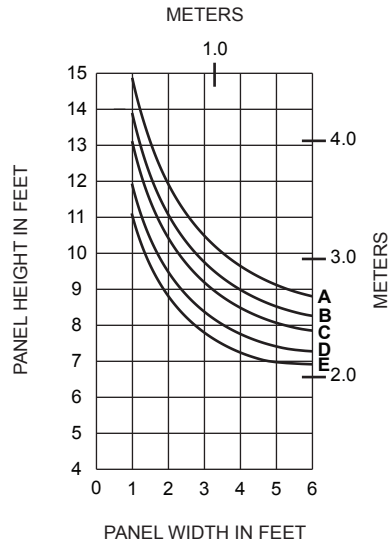
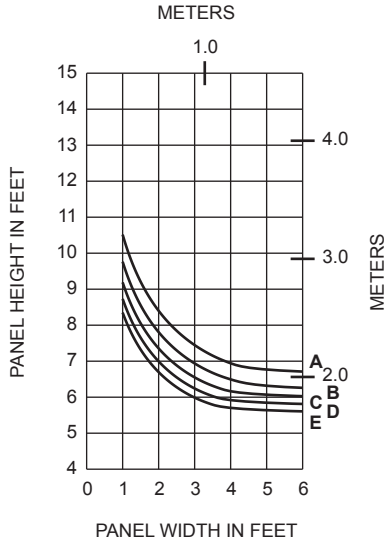
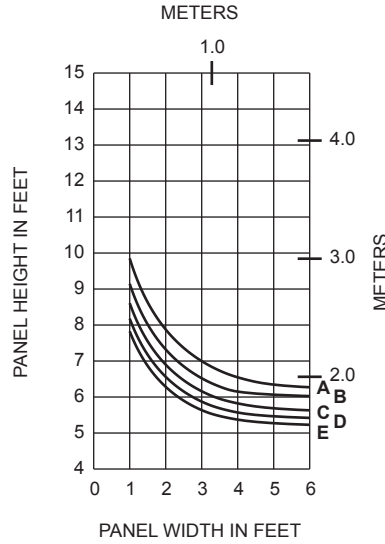

Laws and building and safety codes governing the design and use of glazed entrance, window, and curtain wall products vary widely. Kawneer does not control the selection of product configurations, operating hardware, or glazing materials, and assumes no responsibility therefor.

Kawneer reserves the right to change configuration without prior notice when deemed necessary for product improvement.  
© Kawneer Company, Inc., 2010

	Allowable Stress Design Load	LRFD Ultimate Design Load
<b>A =</b>	<b>20 PSF (960)</b>	<b>33 PSF (1580)</b>
<b>B =</b>	<b>25 PSF (1200)</b>	<b>42 PSF (2000)</b>
<b>C =</b>	<b>30 PSF (1440)</b>	<b>50 PSF (2400)</b>
<b>D =</b>	<b>40 PSF (1920)</b>	<b>67 PSF (3200)</b>
<b>E =</b>	<b>50 PSF (2400)</b>	<b>83 PSF (4000)</b>

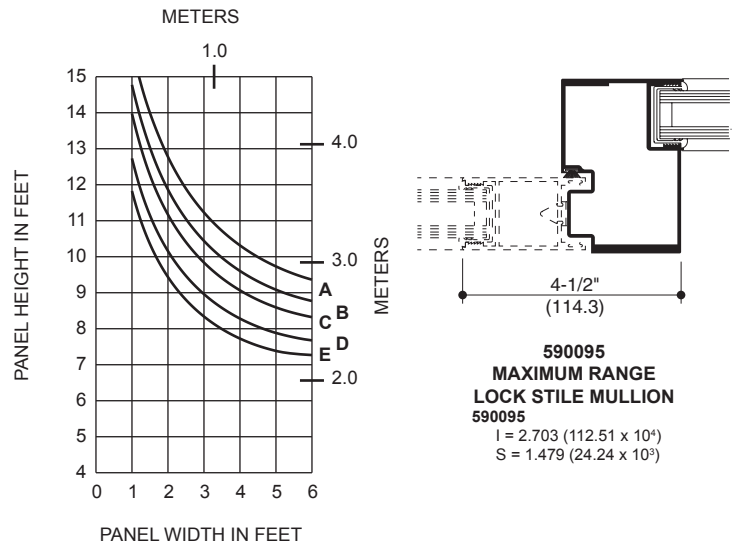
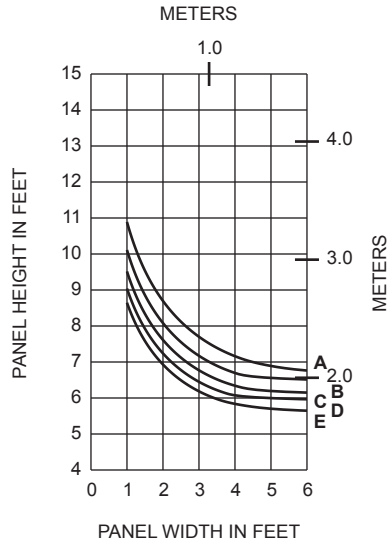
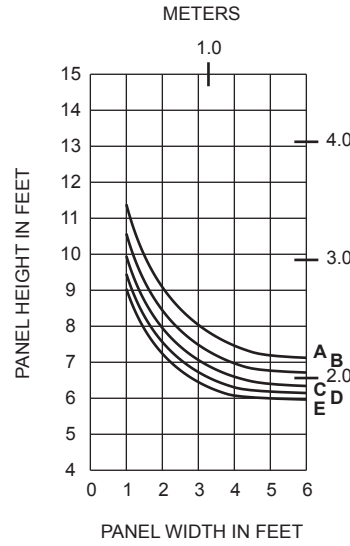

Laws and building and safety codes governing the design and use of glazed entrance, window, and curtain wall products vary widely. Kawneer does not control the selection of product configurations, operating hardware, or glazing materials, and assumes no responsibility therefor.

Kawneer reserves the right to change configuration without prior notice when deemed necessary for product improvement.  
© Kawneer Company, Inc., 2010

Laws and building and safety codes governing the design and use of glazed entrance, window, and curtain wall products vary widely. Kawneer does not control the selection of product configurations, operating hardware, or glazing materials, and assumes no responsibility therefor.

Kawneer reserves the right to change configuration without prior notice when deemed necessary for product improvement.  
© Kawneer Company, Inc., 2010