

COLOR SYSTEM C

ASSOCIATED ARCHITECTURAL STYLES: (16) COLONIAL REVIVAL, (17) NEO-DUTCH COLONIAL, (18) NEO-GEORGIAN, (19) POST-DEPRESSION COLONIAL

As the nineteenth century waned, American domestic architecture began to return to simpler lines inspired in part by our colonial past. With this revival paint colors also changed. Body colors moved towards the pastels; white again became the most popular trim color and was even used for sash. This trend developed in the 1890s, but only for colonial and classically inspired houses; the darker colors found in the High and Late Victorian Styles continued to be popular and it would be inappropriate to use the colonial colors listed for houses not in the Colonial Revival style. Knowledge of true colonial colors was primitive in the late 19th and early 20th centuries. The so-called "Williamsburg" dark reds, uniform blues and greens that resulted from early studies to discover colors used in the colonial era were actually decades in the future.

For the stucco or clapboard, frame colonial, yellow was the most popular body color, although gray or blue was used. Normally these were then trimmed with white or ivory on the cornice, cornerboards, window frames, sash, etc., depending on which gave the lesser contrast. The yellow, gray and blue were less often used as trimming colors for masonry houses where the darker red brick or stone usually was accompanied by white or ivory trim and dark green shutters.



COLOR SYSTEM C

ACCEPTABLE COLOR COMBINATIONS *MS = MUNSELL STANDARD

BODY	TRIM	SASH	SHUTTERS
A:3, A:4, C:1, C:2, C:3, C:4, C:5	C:4, C:5	Match trim color or occasionally B:19	Match trim color or A:8, B:11, B:12, B:13, B:17
Dark brick or stone	A:3, A:4, C:1, C:2, C:3, with C:4, C:5 preferred	Match trim color or occasionally B:19	Match trim color or A:8, B:11, B:12, B:13, B:17



A:3 Light Yellow
MS: 5Y 8/6



A:4 Pale Yellow
MS: 2.5Y 8.5/4



A:8 Blackish Green
MS: 2.5BG 2/2



B:3 Light Yellow
MS: 2.5Y 8/6



B:11 Grayish Olive Green
MS: 5GY 4/2



B:12 Grayish Green
MS: 10G 4/2



B:13 Moderate Olive Brown
MS: 2.5Y 4/4



B:17 Light Olive
MS: 10Y 5/4



B:19 Black
MS: N 0.5/



C:1 Light Bluish Gray
MS: 10B 7/1



C:2 Light Yellow
MS: 2.5Y 8.5/6



C:3 Pale Blue
MS: 10B 6/4

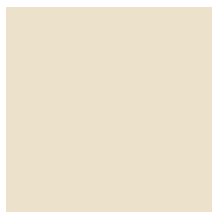

C:4 Yellowish White
MS: 5Y 9/1



C:5 Yellowish White
MS: 2.5Y 9/2

Benjamin Moore HC-145
Van Cortland Blue

Benjamin Moore HC-27
Monterrey White

FIND OUT MORE! www.detroitmi.gov/hdc

SUBMIT ALL DOCUMENTATION TO: hdc@detroitmi.gov



MONTERREY WHITE

VAN COURTLAND
BLUE

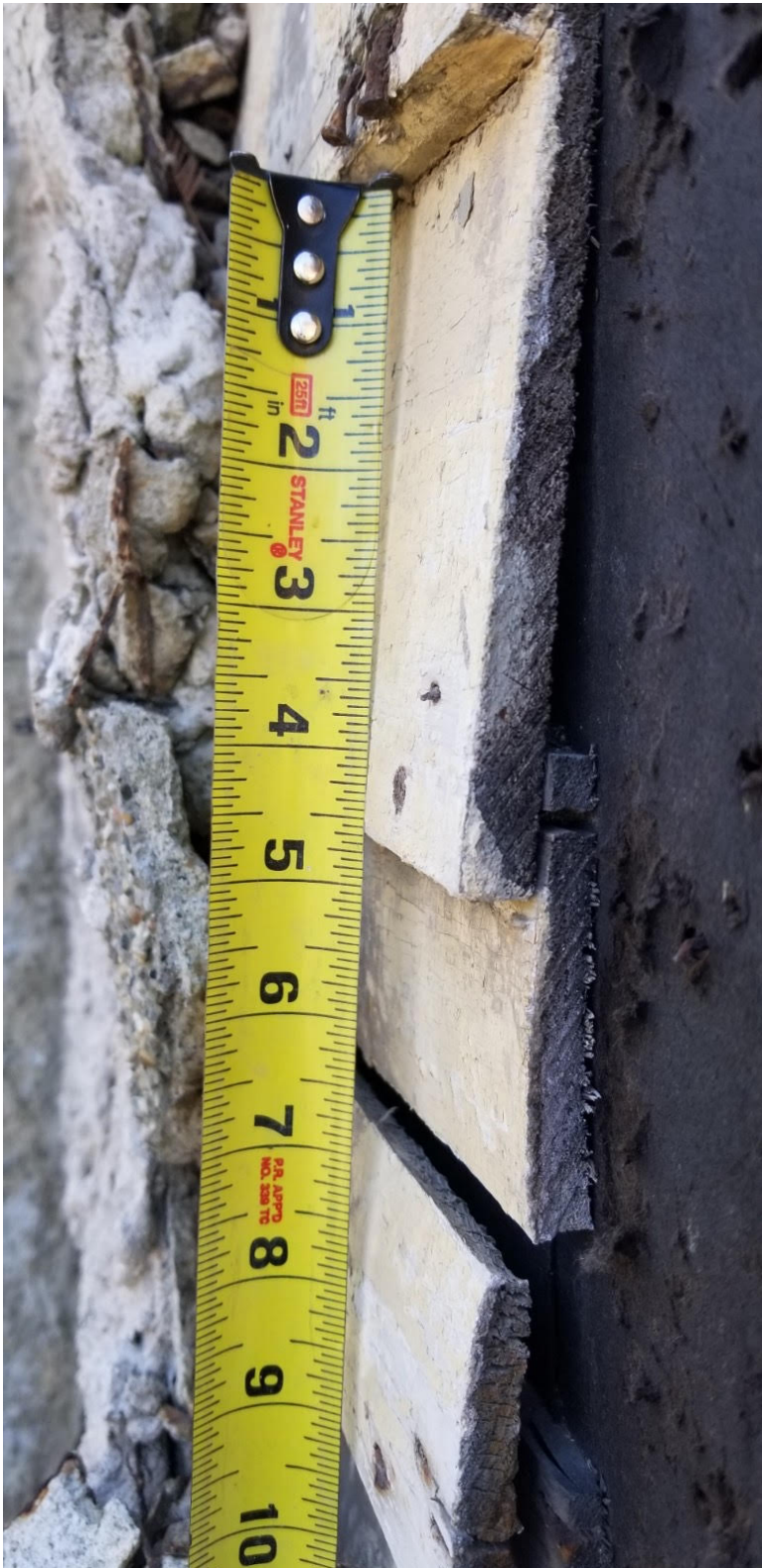

ORIGINAL BEVELED LAP SIDING

6" SIDING W/ 4 1/2" EXPOSURE
7/16" BUTT DIMENSION

Siding

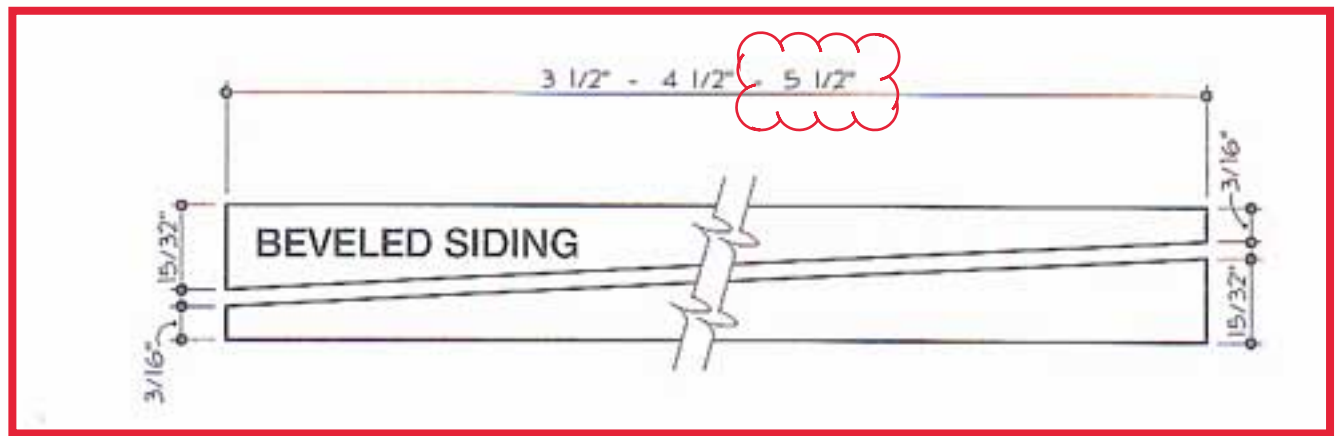

DETROIT FOREST PRODUCTS, INC.
1550 Superior Pkwy
Westland MI 48185
P.734-459-5808

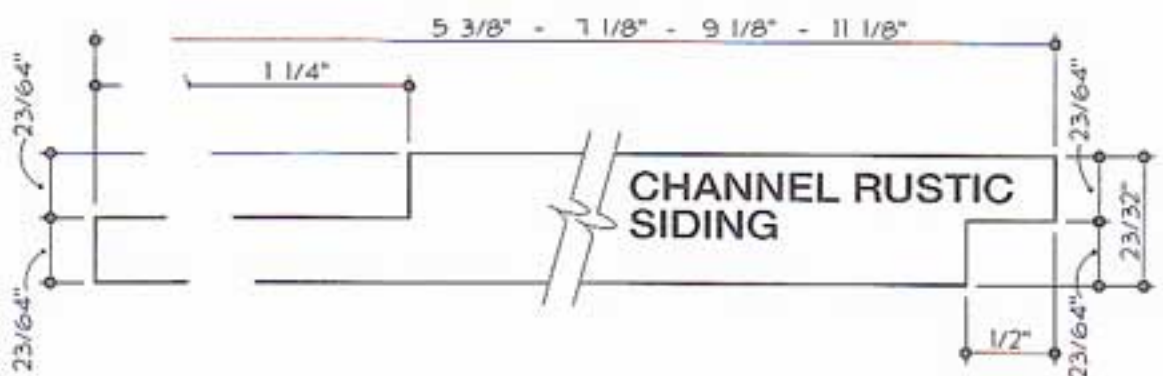
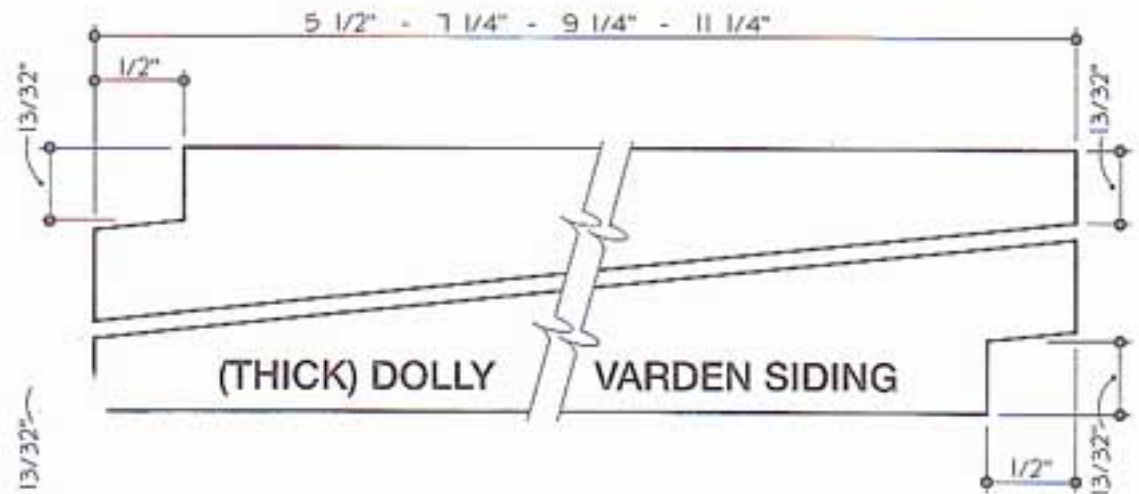
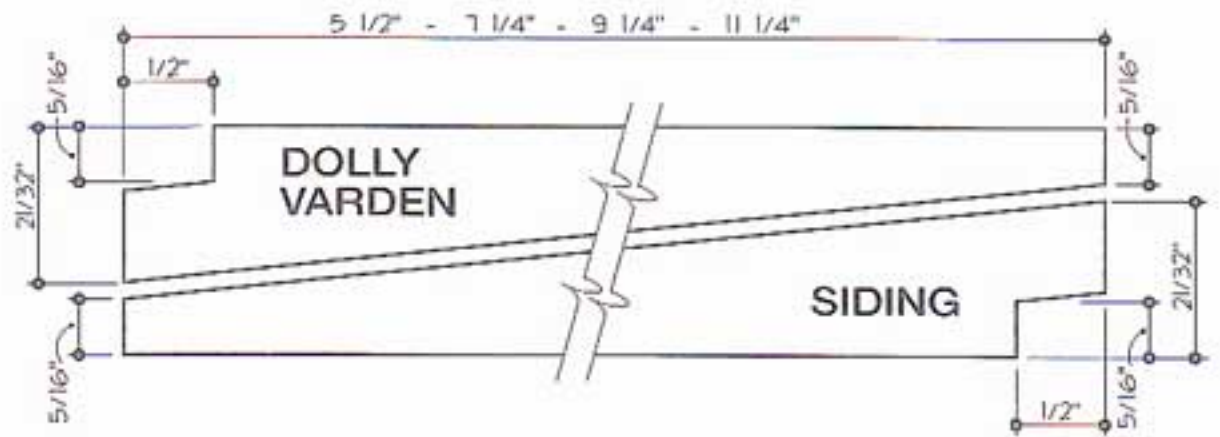
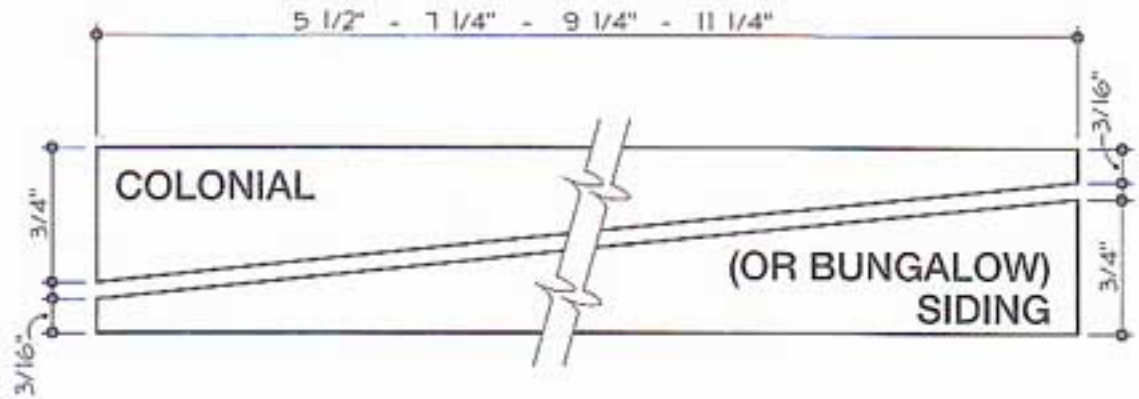

2002BK

2-LIGHT FLUSHMOUNT



Description:	2-light flushmount
Finish:	Matte black
Dimensions:	11-1/2" W x 5" H
Bulbs:	2-60w medium
Installed Weight:	3.3 lbs.
Certification:	Damp location / c UL

Material:	Cast aluminum
Glass:	Frosted
Canopy Dimensions:	11-1/4" dia.
Chain/Wire:	NA
Additional Finishes:	Burled walnut and textured white

SPECIFICATIONS

Certifications/Qualifications

www.kichler.com/warranty

Dimensions

Base Backplate	5.00 X 7.00
Extension	7.00"
Weight	2.50 LBS
Height from center of Wall opening (Spec Sheet)	3.50"
Height	11.00"
Width	6.00"

Light Source

Lamp Included	Not Included
Lamp Type	A19
Light Source	Incandescent
Max or Nominal Watt	60.00
# of Bulbs/LED Modules	1
Max Wattage/Range	60.00
Socket Type	Medium
Socket Wire	150"

Mounting/Installation

Interior/Exterior	Exterior
Location Rating	Wet
Mounting Style	Wall Mount
Mounting Weight	1.50 LBS

FIXTURE ATTRIBUTES



Housing

Diffuser Description	Clear Seeded
Primary Material	ALUMINUM

Product/Ordering Information

SKU	49892BK
Finish	Black
Style	Traditional
UPC	783927801270

Finish Options

-  Black
-  Olde Bronze



ALSO IN THIS FAMILY



PROPOSED FENCING

Internet #303863981 Model #318735 Store SKU #559067



6 ft. x 8 ft. Cedar Dog-Ear Fence Panel

265

★★★★★ (38) Write a Review Questions & Answers (13)

- Cedar is naturally resistant to rot and decay
- Comes pre-assembled for easy, DIY installation
- See Pro Desk for special order availability
- See More Details

\$85⁹⁷

Save up to \$100* on your qualifying purchase. Apply for a Home Depot Consumer Card

How to Get It

Delivering to: 48235 | Change

Store Pickup
Pickup Today
FREE

Ship to Home
Not available for this item

Scheduled Delivery
As soon as Tomorrow
\$79.00

47 in stock at **Detroit 7 Mile/Meyers**
Check Nearby Store

6'-0" TALL WOOD PRIVACY FENCE



3'-0" TALL PICKET FENCE

NOTE: ALL FENCING TO BE STAINED OR PAINTED IN ACCORDANCE W/ HDC FENCE & HEDGE GUIDELINES

ALLEY

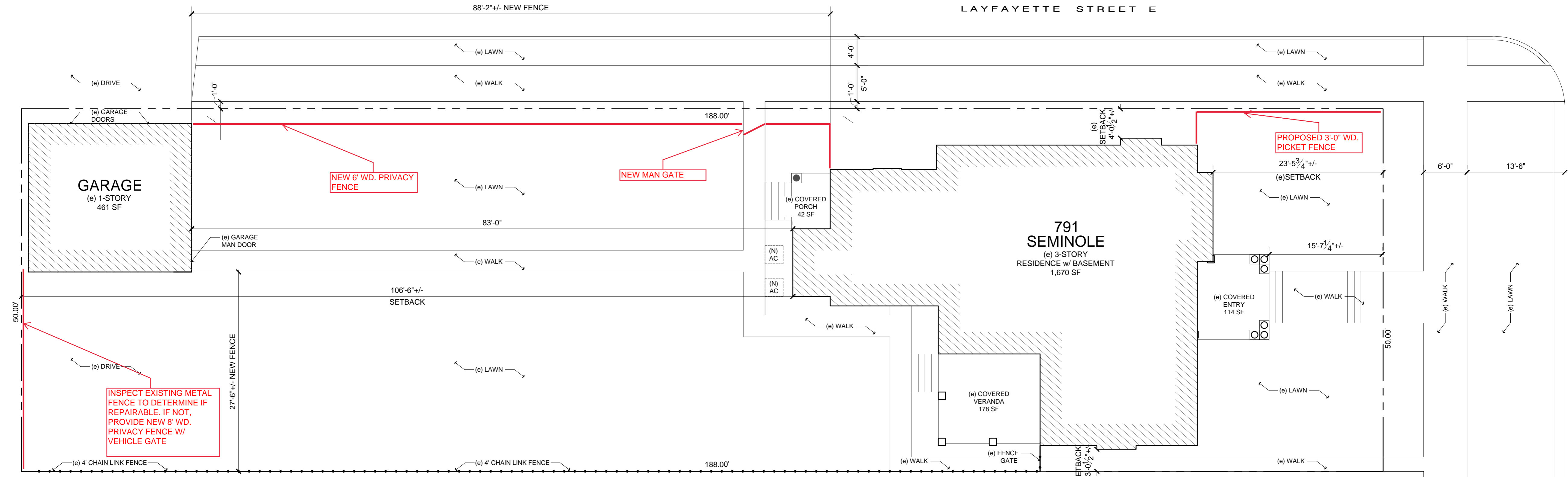

LAYFAYETTE STREET E

SEMINOLE STREET

INSPECT EXISTING METAL FENCE TO DETERMINE IF REPAIRABLE. IF NOT, PROVIDE NEW 8' WD. PRIVACY FENCE W/ VEHICLE GATE

PROPOSED 3'-0" WD. PICKET FENCE

NEW MAN GATE

NEW 6' WD. PRIVACY FENCE

791 SEMINOLE
(e) 3-STORY RESIDENCE w/ BASEMENT
1,670 SF

GARAGE
(e) 1-STORY
461 SF

(e) COVERED VERANDA
178 SF

(e) COVERED ENTRY
114 SF

(e) COVERED PORCH
42 SF

188.00'

83'-0"

106'-6" +/-
SETBACK

50.00'

27'-6" +/- NEW FENCE

88'-2" +/- NEW FENCE

SETBACK
3'-0 1/2" +/-

(e) SETBACK
4'-0 1/2" +/-

23'-5 3/4" +/-
(e) SETBACK

15'-7 1/4" +/-

6'-0"

13'-6"

188.00'

50.00'

(e) DRIVE

(e) GARAGE DOORS

(e) GARAGE MAN DOOR

(e) COVERED PORCH

(N) AC

(N) AC

(e) COVERED VERANDA

(e) COVERED ENTRY

(e) LAWN

(e) WALK

(e) LAWN

(e) WALK

(e) LAWN

(e) 4' CHAIN LINK FENCE

4'-0"

5'-0"

(e) WALK

(e) WALK

(e) FENCE GATE

(e) WALK

(e) LAWN

(e) WALK

(e) LAWN

(e) LAWN

(e) WALK

(e) WALK

(e) LAWN

GUTTER COIL



GUTTER COIL

GC027

CONTENTS

- .027 X 11.75"
- 3 Coils Per Skid
- Approximately 350 Lb. Rolls

6GC032

CONTENTS

- .032 X 15"
- 2 Coils Per Skid
- Approximately 350 Lb. Rolls

MINI GUTTER COIL

MGC150 CONTENTS

- .027 x 11.75" • 150 Ft. Coils
- 1 Coil Per Box
- Approximately 58 Lbs. Per Box
- 0.38 Lb./Ft. 2.65 Ft. Per Lb.

6MGC150 CONTENTS

- .032 x 15" • 150 Ft. Coils
- 1 Coil Per Box
- Approximately 83 Lb. Rolls
- 0.55 Lb./Ft. 1.8 Ft. Per Lb.

MGC100 CONTENTS

- .027 x 11.75" • 100 Ft. Coils
- 1 Coil Per Box
- Approximately 38 Lbs. Per Box
- 0.38 Lb./Ft. 2.65 Ft. Per Lb.

6MGC100 CONTENTS

- .032 x 15" • 100 Ft. Coils
- 1 Coil Per Box
- Approximately 58 Lb. Rolls
- 0.55 Lb./Ft. 1.8 Ft. Per Lb.

MGC50 CONTENTS

- .027 x 11.75" • 50 Ft. Coils
- 1 Coil Per Box
- Approximately 19 Lbs. Per Box
- 0.38 Lb./Ft. 2.65 Ft. Per Lb.

6MGC50 CONTENTS

- .032 x 15" • 50 Ft. Coils
- 1 Coil Per Box
- Approximately 30 Lb. Per Box
- 0.55 Lb./Ft. 1.8 Ft. Per Lb.



COLOR LEGEND

RAIN CARRYING COLOR LEGEND

	COLOR	.027 X 11.75	.032 X 11.75	PIPE / AE / BE	.032 X 15.00	6" PIPE / 6AE / 6BE	.032 X 11.875
Pearl Gray	102	Stock	N/A	Stock	Special	Stock	N/A
Tuxedo Gray	112	Stock	N/A	Stock	Stock	Stock	N/A
Low Gloss White	130	Stock	Stock	Stock	Stock	Stock	Stock
Bone	138	Stock	N/A	Stock	N/A	Stock	N/A
High Gloss White	180	Stock	Stock	Stock	Stock	Stock	N/A
Black	200	Stock	Stock	Stock	Stock	Stock	Special
Royal Brown	202	Stock	Stock	Stock	Stock	Stock	Special
Grecian Green	204	Stock	Stock	Stock	Stock	Stock	N/A
Scotch Red	209	Special	N/A	Special	N/A	Special	N/A
Woodland Green	214	Stock	N/A	Stock	N/A	Stock	N/A
Imperial Brown	223	Stock	N/A	Stock	N/A	Stock	N/A
Hickory Clay	238	Stock	Stock	Stock	Stock	Stock	Special
Musket Brown	250	Stock	Stock	Stock	Stock	Stock	Special
Dark Gray	301	Special	N/A	Special	Special	Special	N/A
Sandstone Beige	325	Stock	N/A	Stock	Stock	Stock	N/A
Desert Tan	327	Stock	Special	Stock	N/A	Stock	Special
Light Maple	355	Stock	N/A	Stock	N/A	Stock	N/A
Terratone	360	Stock	N/A	Stock	Stock	Stock	N/A
Pebblestone Clay	422	Stock	N/A	Stock	N/A	Stock	N/A
Wicker	713	Stock	Stock	Stock	Stock	Stock	Special
Coppertone	780	Stock	N/A	Stock	Special	Stock	N/A
Norwegian Wood	791	Stock	N/A	Stock	Special	Stock	N/A
Heather	792	Stock	N/A	Stock	N/A	Stock	N/A
Sandcastle	793	Stock	N/A	Stock	N/A	Stock	N/A
Mocha	795	N/A	Stock	Stock	Stock	Stock	N/A
Almond	801	Stock	N/A	Stock	N/A	Stock	N/A
Pewter	805	Stock	Stock	Stock	N/A	Stock	N/A
Cream	817	Stock	N/A	Stock	N/A	Stock	N/A
Bronze	818	Stock	N/A	Stock	Stock	Stock	N/A
Herringbone	819	Stock	N/A	Stock	Special	Stock	N/A
Cranberry	820	Stock	Stock	Stock	N/A	Stock	N/A
Ivy	821	Stock	N/A	Stock	N/A	Stock	N/A
Pacific Blue	822	Stock	N/A	Stock	N/A	Stock	N/A
Buckskin	841	Stock	N/A	Stock	N/A	Stock	N/A
Ivory	901	Stock	N/A	Stock	N/A	Stock	N/A
Copper							

Contact Customer Service / Sales for details.

- Stock Item
- Special Item: Please allow 3-5 days.
- Not Available. 5000 Lb. minimum.

GUTTER ACCESSORIES

LNAE

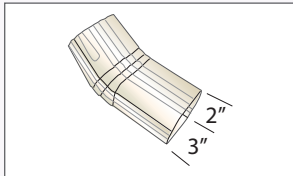

LONGNOSE A ELBOW

30° Bend

130° Low Gloss
180° High Gloss
202 Royal Brown
238 Hickory
250 Musket Brown
713 Wicker

CARTON CONTENTS
• 30 Pieces Per Carton
• 7 Lbs.

CP

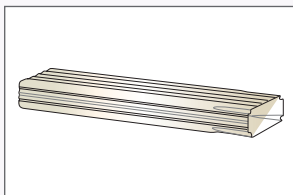

2" X 3" CONDUCTOR PIPE

See pg. 32 for Color Legend

CARTON CONTENTS

• (10) 10 Ft. Pieces
• 100 Ft. Per Carton
• 25 Lbs.

• (10) 8 Ft. Pieces
• 80 Ft. Per Carton
• 20 Lbs.

2X3YD

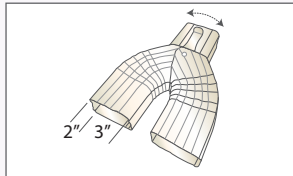

2" X 3" Y DIVERTERS

130° Low Gloss White
180° High Gloss White

CARTON CONTENTS
• 10 Pieces Per Carton • 6 Lbs.

AE

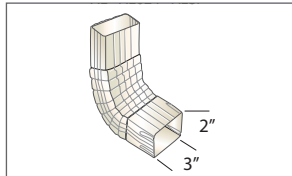

STYLE A ELBOW

75° Bend

See pg. 32 for Color Legend

CARTON CONTENTS

• 30 Pieces Per Carton
• 7 Lbs.

BE

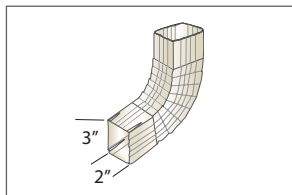

STYLE B ELBOW

75° Bend

See pg. 32 for Color Legend

CARTON CONTENTS

• 30 Pieces Per Carton
• 7 Lbs.

AE OFFSET

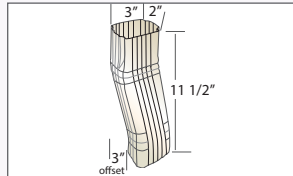

STYLE A OFFSET ELBOW

130° Low Gloss White
180° High Gloss White

CARTON CONTENTS

• 20 Pieces Per Carton
• 6 Lbs.

BE OFFSET

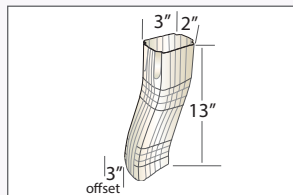

STYLE B OFFSET ELBOW

130° Low Gloss White
180° High Gloss White

CARTON CONTENTS

• 20 Pieces Per Carton
• 6 Lbs.

5LEAFDROP

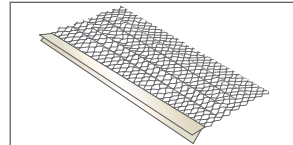

5" LEAF COVER

CARTON CONTENTS

• 50 Pieces • 4 Ft. Lengths
• 18 Lbs.

5GLD

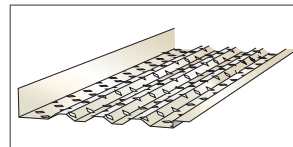

5" GUTTERLOCK DIAMOND

200 Black
280 White

CARTON CONTENTS

• 50 Pieces Per Carton • 6 Ft. Per Piece
• 300 Ft. Per Carton
• 58 Lbs. Per Carton

5CLS40

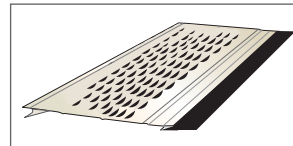

CLEAN SWEEP

For 5" Gutter

Light Gray

CARTON CONTENTS

• 25 Pieces • 4 Ft. Lengths
• 100 Ft. Per Carton • 17 Lbs.

50TM

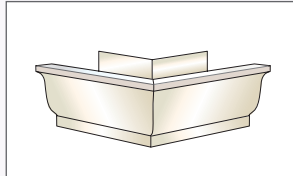

5" OUTSIDE MITRE

See pg. 32 for Color Legend

CARTON CONTENTS

• 20 Pieces Per Carton
• 7 Lbs.

5INM

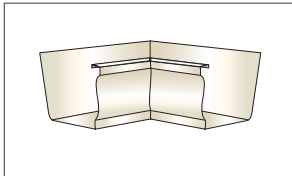

5" INSIDE MITRE

See pg. 32 for Color Legend

CARTON CONTENTS

• 20 Pieces Per Carton
• 7 Lbs.

RT-SLOCK

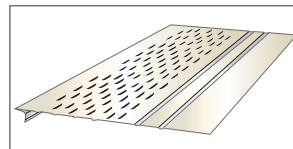

RAIN TRAP

For 5" and 6" Gutter

102 Pearl Gray
200 Black
202 Royal Brown
238 Clay
250 Musket Brown
280 White
360 Terratone
713 Wicker
801 Almond

CARTON CONTENTS

• 25 Pieces • 4 Ft. Lengths
• 100 Ft. Per Carton • 17 Lbs.

GUTTER ACCESSORIES

5ENL

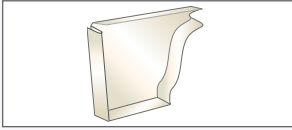

5" LEFT END CAP
See pg. 32 for Color Legend
CARTON CONTENTS
• 50 Pieces Per Carton
• 5 Lbs.

5ENR

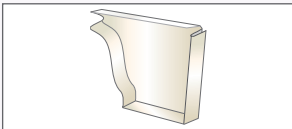

5" RIGHT END CAP
See pg. 32 for Color Legend
CARTON CONTENTS
• 50 Pieces Per Carton
• 5 Lbs.

CPB

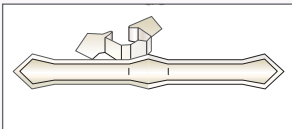

CONDUCTOR PIPE BAND
See pg. 32 for Color Legend
CARTON CONTENTS
• 100 Pieces Per Carton
• 5 Lbs.

5HWA

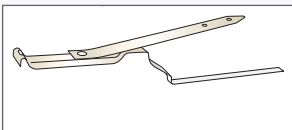

WRAP AROUND HANGER
130° Low Gloss White
180° High Gloss White
202 Royal Brown
CARTON CONTENTS
• 100 Pieces Per Carton
• 5 Lbs.

5FAB

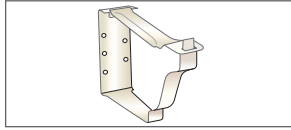

FASCIA BRACKETS
130° Low Gloss White
180° High Gloss White
CARTON CONTENTS
• 100 Pieces Per Carton
• 12 Lbs.

5KREJ

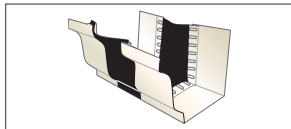

5" RUBBER EXPANSION JOINT
Mill Finish
CARTON CONTENTS
• 12 Pieces Per Carton
• 3 Lbs.

7SPKA

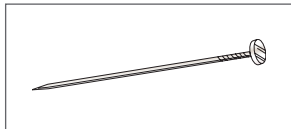

SPIKES
130 Low Gloss White
CARTON CONTENTS
• 500 Pieces Per Carton
• 16 Lbs.

PIPE CLIPS

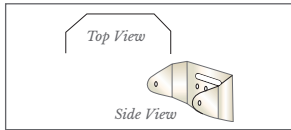

PIPE CLIPS
130° Low Gloss White
180° High Gloss White
202 Royal Brown
204 Grecian Green
238 Hickory
250 Musket Brown
325 Sandstone Beige
360 Terratone
713 Wicker
818 Bronze
820 Cranberry
CARTON CONTENTS
• 50 Pieces Per Carton
• 4 Lbs.

5ISM

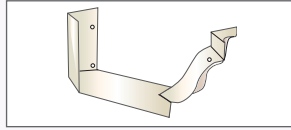

INSIDE STRIP MITRE
102 Pearl Gray
112 Tuxedo Gray
130° Low Gloss White
180° High Gloss White
200 Black
202 Royal Brown
204 Grecian Green
223 Imperial Brown
238 Hickory
250 Musket Brown
325 Sandstone Beige
327 Desert Tan
355 Light Maple
360 Terratone
713 Wicker
780 Coppertone
791 Norwegian Wood
793 Sandcastle
805 Pewter
817 Cream
818 Bronze
819 Herringbone
820 Cranberry
821 Ivy
822 Pacific Blue
841 Buckskin
901 Ivory
CARTON CONTENTS
• 20 Pieces Per Carton • 4 Lbs.

50SM

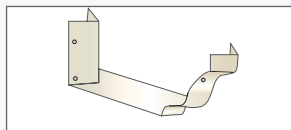

OUTSIDE STRIP MITRE
See above color list for 5ISM
CARTON CONTENTS
• 20 Pieces Per Carton • 4 Lbs.

CLEAT

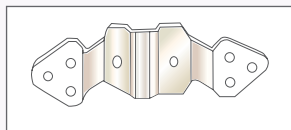

CLEAT
130 Low Gloss White
CARTON CONTENTS
• 100 Pieces Per Carton • 3 Lbs.

BIS

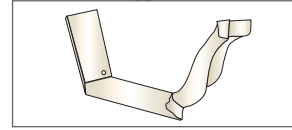

BAY INSIDE STRIP MITRE
130° Low Gloss White
180° High Gloss White
CARTON CONTENTS
• 20 Pieces Per Carton • 4 Lbs.

BOS

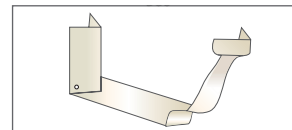

BAY OUTSIDE STRIP MITRE
130° Low Gloss White
180° High Gloss White
CARTON CONTENTS
• 20 Pieces Per Carton • 4 Lbs.

5FER



FERRULES
Mill Finish
CARTON CONTENTS
• 500 Pieces Per Carton • 25 Lbs.

OUT

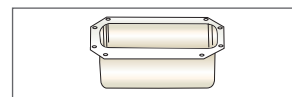

OUTLET TUBE
2" X 3"
Mill Finish
CARTON CONTENTS
• 30 Pieces Per Carton • 3 Lbs.

RDOUT RDOUT275

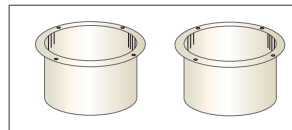

2.375 2.75
2 3/8" ROUND 2 3/4" ROUND
OUTLET TUBE OUTLET TUBE
Mill Finish Mill Finish
CARTON CONTENTS
• 250 Pieces • 15 Lbs.

GUTTER ACCESSORIES

5HDHNGER

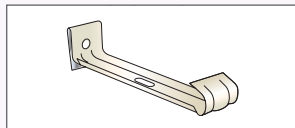

5" HIDDEN HANGERS

Mill Finish

CARTON CONTENTS
• 100 Pieces • 5 Lbs.

5MHOOK

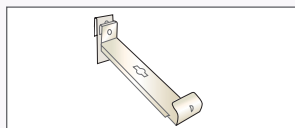

M SERIES HANGER

Mill Finish

CARTON CONTENTS
• 100 Pieces • 5 Lbs.

5HHSCREW

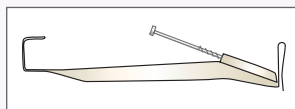

5" HIDDEN HANGER WITH SCREW

Mill Finish

CARTON CONTENTS
• 500 Pieces • 37 Lbs.

GW5WH

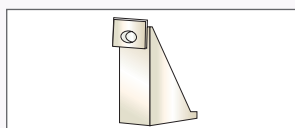

GUTTER WEDGE

White Only

CARTON CONTENTS
• 100 Pieces • 4 Lbs.

FUNW

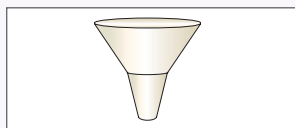

2" X 3" FUNNEL

130° Low Gloss

BOX CONTENTS
• 12 Pieces Per Carton
• 13 Lbs. Per Box

VAM5

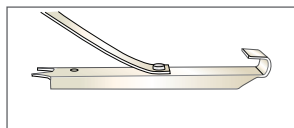

VAMPIRE HANGER

Mill Finish

CARTON CONTENTS
• 100 Pieces
• 8 Lbs.

5SLP

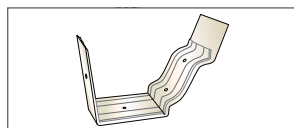

SLIP JOINT CONNECTOR

130° Low Gloss White
180° High Gloss White

CARTON CONTENTS
• 50 Pieces
• 7 Lbs.

PR



POP RIVET

102 Pearl Gray/805 Pewter
112 Tuxedo Gray
130 Low Gloss
138 Bone
200 Black
202 Royal Brown/
223 Imperial Brown
204 Grecian Green/
214 Woodland Green
209 Scotch Red
238 Hickory
250 Musket Brown
325/827 Sandstone Beige
327 Desert Tan
355 Light Maple
360 Terratone
422 Pebblestone Clay
713 Wicker
780 Coppertone
791 Norwegian Wood
792/318 Heather/Silver Ash
793 Sandcastle
801 Almond/817 Cream
818 Bronze
819 Herringbone
820 Cranberry
821 Ivy
822 Pacific Blue
841 Buckskin

BOX CONTENTS
• 100 Pieces Per Bag
• 10 Bags Per Box
• 3 Lbs. Per Box

TBT

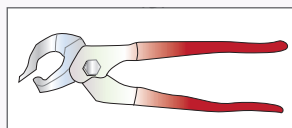

VAMPIRE TOOL

CARTON CONTENTS

• 1 Piece
• 1 Lb.

GM12000

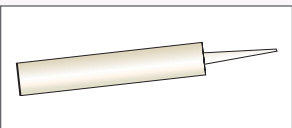

BOSS GUTTER SEAL

V.O.C. Compliant
Clear

CARTON CONTENTS
• 12 Pieces Per Carton
• (12) 10 oz. Cartridges
• 12 Lbs.

BOSS

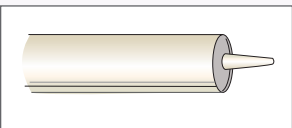

BOSS CAULKING COMPOUND

V.O.C. Compliant
Siding and Soffit Colors

CARTON CONTENTS
• 12 Pieces
• (12) 10 oz. Cartridges
• 12 Lbs. Per Box

TUPS

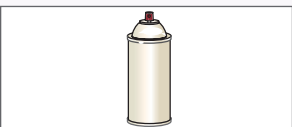

TOUGH UP SPRAY PAINT

Gutter Colors

BOX CONTENTS
• (12) 12 oz. Cans • 13 Lbs. Per Box

5STR

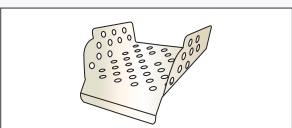

STRAINER

Mill Finish

BOX CONTENTS
• 30 Pieces Per Carton
• 5 Lbs. Per Box

ZSCREWS

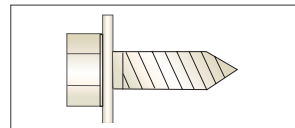

8 X 1/2" ZIP SCREWS

102 Pearl Gray/805 Pewter
112 Tuxedo Gray
138 Bone
200 Black
202 Royal Brown
204 Grecian Green/
214 Woodland Green
209 Scotch Red
223 Imperial Brown
238 Hickory
250 Musket Brown
280 White
355 Light Maple
360 Terratone
422 Pebblestone Clay
713 Wicker
780 Coppertone
801 Almond/817 Cream
818 Bronze
819 Herringbone
820 Cranberry
821 Ivy
841 Buckskin
CARTON CONTENTS
• 100 Pieces Per Bag

5ENS

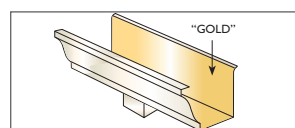

END SECTION WITH OUTLETS

130 Low Gloss
180 High Gloss

CARTON CONTENTS
• 30 Pieces • 12 Lbs. Per Box

5HHSTRAP

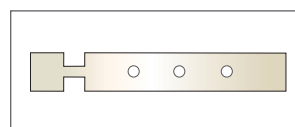

HIDDEN HANGER STRAPS

Mill Finish

BOX CONTENTS
• 100 Pieces • 2 Lbs.

GUTTER ACCESSORIES

6CP

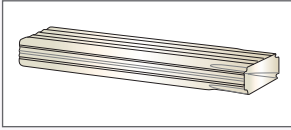

3" X 4" CONDUCTOR PIPE
See pg. 32 for Color Legend
CARTON CONTENTS
• (10) 10 Ft. Pieces
• 100 Ft. Per Carton • 30 Lbs.

6AE

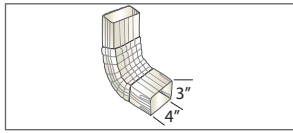

STYLE A ELBOW
75° Degree Bend
See pg. 32 for Color Legend
CARTON CONTENTS
• 15 Pieces Per Carton
• 6 Lbs.

6BE

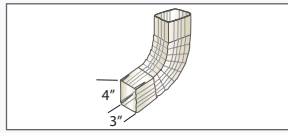

STYLE B ELBOW
75° Degree Bend
See pg. 32 for Color Legend
CARTON CONTENTS
• 15 Pieces Per Carton
• 6 Lbs.

6LNAE

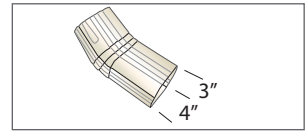

LONGNOSE A ELBOW
30° Bend
130° Low Gloss White
180° High Gloss White
202 Royal Brown
CARTON CONTENTS
• 24 Pieces Per Carton • 6 Lbs.

6ISM

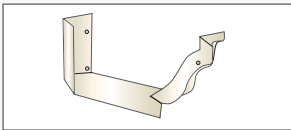

6" INSIDE STRIP MITRE
130° Low Gloss White
180° High Gloss White
202 Royal Brown
238 Hickory
250 Musket Brown
325 Sandstone Beige
360 Terratone
713 Wicker
791 Norwegian Wood
CARTON CONTENTS
• 20 Pieces Per Carton
• 4 Lbs.

6OSM

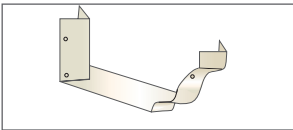

6" OUTSIDE STRIP MITRE
130° Low Gloss White
180° High Gloss White
202 Royal Brown
238 Hickory
250 Musket Brown
325 Sandstone Beige
360 Terratone
713 Wicker
791 Norwegian Wood
CARTON CONTENTS
• 20 Pieces Per Carton
• 4 Lbs.

6BIS

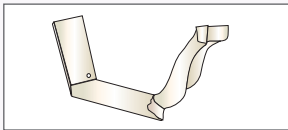

6" BAY INSIDE STRIP MITRE
130° Low Gloss White
CARTON CONTENTS
• 20 Pieces Per Carton
• 4 Lbs.

6BOS

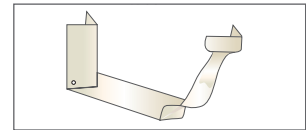

6" BAY OUTSIDE STRIP MITRE
130° Low Gloss White
CARTON CONTENTS
• 20 Pieces Per Carton
• 4 Lbs.

6KREJ

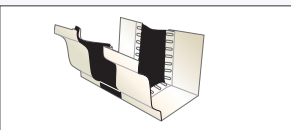

6" RUBBER EXPANSION JOINT
Mill Finish
CARTON CONTENTS
• 12 Pieces Per Carton
• 4 Lbs.

3X4YD

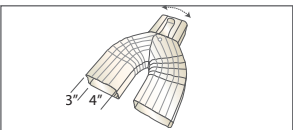

3" X 4" Y DIVERTERS
130° Low Gloss White
CARTON CONTENTS
• 10 Pieces Per Carton • 7 Lbs.



GUTTER ACCESSORIES

6INM

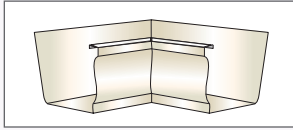

6" INSIDE MITRE
See pg. 32 for Color Legend

CARTON CONTENTS
• 20 Pieces Per Carton
• 12 Lbs.

6OUT

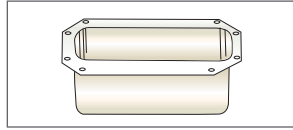

3" X 4" OUTLET TUBE
Mill Finish

CARTON CONTENTS
• 50 Pieces Per Carton
• 5 Lbs.

6HHSREW

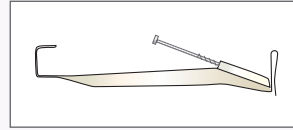

6" HIDDEN HANGER WITH SCREWS
Mill Finish

CARTON CONTENTS
• 300 Pieces Per Carton
• 27 Lbs.

6HDHNGER

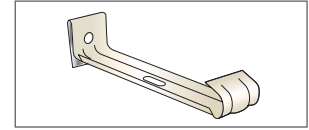

6" HIDDEN HANGER
Mill Finish

CARTON CONTENTS
• 100 Pieces Per Carton
• 25 Lbs.

60TM

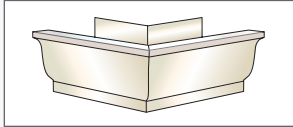

6" OUTSIDE MITRE
See pg. 32 for Color Legend

CARTON CONTENTS
• 20 Pieces Per Carton
• 12 Lbs.

8SPKA



8" SPIKES
130° Low Gloss White

CARTON CONTENTS
• 500 Pieces Per Carton
• 17 Lbs.

6FUNW130

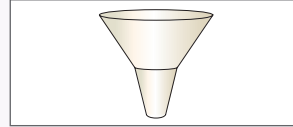

3" X 4" FUNNEL
130° Low Gloss

CARTON CONTENTS
• 12 Pieces Per Carton
• 4 Lbs. Per Box

GW6WH

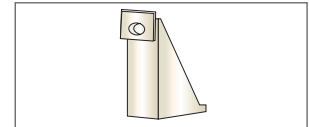

6" GUTTER WEDGE
White Only

CARTON CONTENTS
• 50 Pieces Per Carton
• 3 Lbs.

6ENL

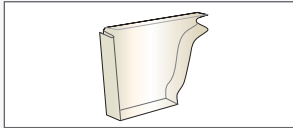

6" LEFT END CAP
See pg. 32 for Color Legend

CARTON CONTENTS
• 50 Pieces Per Carton
• 5 Lbs.

6PIPE CLIPS

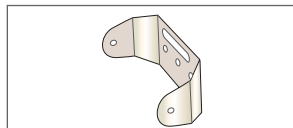

6" PIPE CLIPS
130 Low Gloss
180 High Gloss
202 Royal Brown
238 Hickory
250 Musket Brown
325 Standstone Beige
360 Terratone
713 Wicker
818 Bronze
820 Cranberry

CARTON CONTENTS
• 50 Pieces Per Carton
• 4 Lbs.

6 LEAFDROP

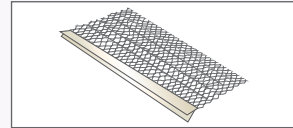

6" LEAF COVER

CARTON CONTENTS
• 50 Pieces • 4 Ft. Lengths
• 18 Lbs.

6GLD

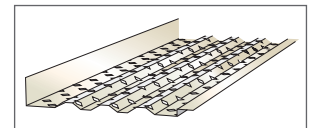

6" GUTTERLOCK DIAMOND
200 Black
280 White

CARTON CONTENTS
• 50 Pieces Per Carton
• 6 Ft. Per Piece
• 300 Ft. Per Carton

6ENR

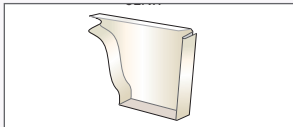

6" RIGHT END CAP
See pg. 32 for Color Legend

CARTON CONTENTS
• 50 Pieces Per Carton
• 5 Lbs.

Color Selection

These color samples are as close as possible to actual colors offered, within the limits of color chip reproduction.



102 - PEARL GRAY



105 - ANTIQUE IVORY



112 - TUXEDO GRAY



200 - BLACK



202 - ROYAL BROWN



204 - GRECIAN GREEN

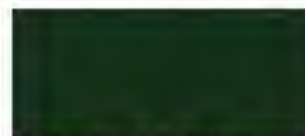

214 - WOODLAND GREEN



215 - AUTUMN RED



223 - IMPERIAL BROWN

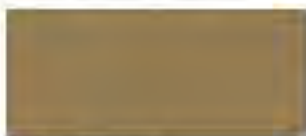

224 - BUCKSKIN



238 - HICKORY
336 - NATURAL CLAY



250 - MUSKET BROWN



253 - CAREY TAN

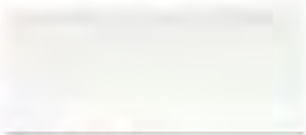

280 - WHITE

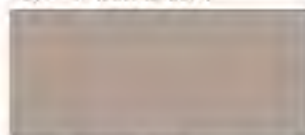

318 - SILVER ASH



325 - SANDSTONE BEIGE



327 - DESERT TAN



355 - LIGHT MAPLE



614 - CREAM / 817 - CREAM



620 - ALPINE BLUE / 810 - SHALE



713 - WICKER
334 - PRAIRIE SAND



791 - NORWEGIAN WOOD



792 - HEATHER



793 - SANDCASTLE
833 - SAND

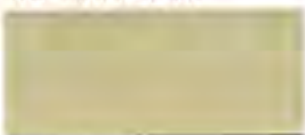

801 - ALMOND



805 - PEWTER
397 - STERLING GRAY



818 - BRONZE



819 - HERRINGBONE

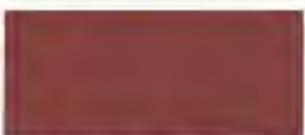

820 - CRANBERRY

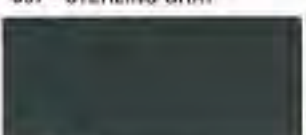

821 - IVY



822 - PACIFIC BLUE



827 - CHAMPAGNE



901 - IVORY

PROPOSED REAR DOOR



EXISTING KITCHEN DOOR & SECURITY DOOR PROPOSED FOR REPLACEMENT (WEST FACADE)



EXISTING GRADE DOOR TO BASEMENT W/ SECURITY DOOR PROPOSED FOR REPLACEMENT (EAST FACADE)



PROPOSED REPLACEMENT

\$339.00

★★★★★ 163

[View Q&A](#)

\$57 / Month

Suggested payments with 6 month special financing

[Learn how](#)

Therma-Tru Benchmark Doors 36-in x 80-in Fiberglass Craftsman Right-Hand Inswing Ready to paint Unfinished Prehung Single Front Door with Brickmould

Item #833539 Model #BMTT626371

- Flush-glazed glass built directly into the door provides a clean, seamless appearance and allows for more natural light
- Fiberglass resists cracking, warping, splitting and denting, offering a low-maintenance, high-performance door option
- Complete door system includes all necessary components like jambs, weatherstrip, sill and hinges in complementing finish colors

Handing

Right-Hand Inswing



1



Qty

Hurry, Low in Stock

Add to Cart

CHAT NOW

FREE | Reverso en español

THERMA-TRU
Benchmark® Doors

Fiberglass Entry Doors



IMAGINE the
POSSIBILITIES

Thousands of combinations for your home

Available at



Go beyond the aisle.
More options available.

To order additional brochures use Lowe's Fax on Demand form.
©2016 Therma-Tru Corp. All rights reserved. THERMA-TRU
BENCHMARK and the Red Door Logo are trademarks of
Therma-Tru Corp. Therma-Tru Corp. is an operating company of
Fortune Brands Home & Security, Inc. HESB/JAN 16



THERMA-TRU
Benchmark® Doors

Create your own Benchmark for beauty.

Add elegance to the exterior of your home by creating a warm, welcoming entryway that is distinctively yours with Therma-Tru® Benchmark® entry doors. Offering an array of fiberglass designs, decorative glass patterns and complementary finishing colors to choose from. You can easily create a customized entryway that is full of character and style.



LIFETIME
LIMITED
WARRANTY

Your Therma-Tru. Benchmark entryway system holds up in all kinds of weather and is backed by a Lifetime Limited Warranty.⁽¹⁾



Energy Efficiency – Up to four-times more than wood ⁽²⁾

Built with a polyurethane foam core that offers up to four times the insulating R-Value of wood, fiberglass doors help insulate against cold and heat for exceptional energy efficiency.



Look for the Energy Star logo or visit www.benchmarkdoors.com to find out which doors qualify.

Attractive and Affordable – Authentic appeal of wood

Replicate the warm, authentic appeal of wood without worrying about the hassles and shortcomings often associated with real wood. If you prefer a smooth, seamless surface, fiberglass entry doors can also deliver that sleek appearance.

Low Maintenance – High Performance

A fiberglass entryway system retains a refined, fresh new look longer, requiring less upkeep. Dependable and durable, resistant to dents, rust and rotting.

Secure and Impact Resistant – Enhanced technology for your safety and peace of mind

The durable fiberglass skin with polyurethane core is more resistant to damage than traditional wood doors. ⁽²⁾

(1) For complete warranty details, please visit the Lowe.com product details page. (2) Comparison of fiberglass to wood doors (both without glass). (3) ENERGY STAR is a joint program of the U.S. Environmental Protection Agency and the U.S. Department of Energy, helping us all save money and protect the environment through energy-efficient products and practices. Look for the Energy Star logo or visit www.benchmarkdoors.com to find out which products qualify.



3 Different Ways to Get Inspired.

When you envision your home, how inviting is your entryway? If you're like most, this may be your first door purchase. And whether you are looking for energy-efficiency, security or curb appeal, it's also an opportunity to transform your entryway into one that reflects your personal style.



Style.

Consider a door design that will complement your home's architectural style.



Finish.

When choosing a finish for your door, your home's roof, siding, windows, trim and garage door should be taken into consideration, as well as interior woodwork.



Purpose.

Therma-Tru Benchmark offers customizable options to support area building codes, your home's existing entryway configuration, desired privacy glass needs, energy efficiency concerns as well as additional security features.



Shop for Style

In the pages that follow, we've concentrated on five of the most common residential architectural styles, including Arts & Crafts, Traditional, Eclectic, Contemporary and Old World. Each is accompanied by signature style elements and brief descriptions, plus carefully selected style-specific door details that will add that genuine architectural character to your home.



The System

A Therma-Tru Benchmark entry door system is engineered to work together at the most critical points where a door can fail, letting in air and moisture. By forming a tight seal against drafts and leaks, these components can help maintain weather resistance and energy efficiency, and help protect the door and home against costly damage and deterioration.



1. The glass system – Triple pane insulated decorative safety glass¹

Each glass assembly is made with two layers of safety glass surrounding the decorative glass. Insulating air spaces between the inner and outer panes help prevent heat, cold and moisture from passing through.

2. Compression weatherstrip

Our compression weatherstrip is filled with foam that remains flexible and helps seal your entryway against moisture and air infiltration in most weather conditions.

3. Leak protection pad

This feature reduces a typical point of air and moisture infiltration, providing a special corner “pocket” that helps keep air and moisture from creeping through.

4. Heavy-duty door sweep

Another energy-saving feature, our door bottom sweep is made with dual bulbs and dual fins that help form a tight seal against air, draft and water leaks.

5. Rot-resistant adjustable sill

The cap is formed of a maintenance-free composite material that won't decay or absorb moisture like wood. Adjustment hardware is made of sturdy, corrosion-resistant steel.

6. Rot-resistant jamb

These jambs help protect against rot and insect damage.

7. Optional multi-point locking system

Add greater security and stability with the multi-point locking system. Made with corrosion-resistant stainless steel for longer, more durable performance, it also offers the security of three door locks.

(1) Double pane insulated safety glass on clear glass with grilles and wrought iron designs.

Privacy

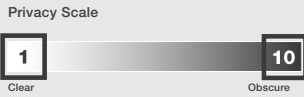

Whether you're looking for obscure privacy or an unobstructed clear scenic view, our glass portfolio offers you a variety of privacy options to accommodate your needs.

Low-E

Factory-coated Low-E glass, available as an option for clear glass, delivers exceptional energy efficiency.

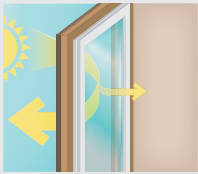

In cold weather, Low-E glass can help reduce the loss of heat by reflecting the heat back inside the home.



In warm weather, Low-E glass reflects the sun's rays off of the glass, helping to keep the interior of the home cool.



Look for the Energy Star logo or visit www.benchmarkdoors.com to find out which doors qualify.

Most Therma-Tru Benchmark doors meet ENERGY STAR® program qualifications for energy efficiency and are specially crafted with a polyurethane foam core.



Your Therma-Tru® Benchmark® entryway system holds up in all kinds of weather and is backed by a Lifetime Limited Warranty.⁽¹⁾



Fiberglass doors are low-maintenance. Unlike wood or steel doors, durable fiberglass is resistant to cracks, dents and rust.



IMPACT-RATED

Impact-rated doors meet Florida coastal region codes and regulations.⁽²⁾

(1) For complete warranty details, please visit the Lowe.com product details page.

(2) Product approvals show that the door system meets applicable codes when selected, assembled and installed as instructed.

Design Your Door

Available Pre-Hung
Entry Door Sizes⁽³⁾



	Slab Width	Single Door	Single Door, 1 Sidelite	Single Door, 2 Sidelites	Double Door	Single Door, 2 Sidelites, Rectangular Transom	Single Door, 2 Sidelites, Elliptical Transom
6-ft, 8-in Tall	32-in wide	33-½-in x 81-½-in	47-in x 81-½-in	60-½-in x 81-½-in	66-¼-in x 81-½-in	N/A	N/A
	36-in wide	37-½-in x 81-½-in	51-in x 81-½-in	64-½-in x 81-½-in	74-¼-in x 81-½-in	64-½-in x 95- ¹ / ₈ -in	64-½-in x 95- ³ / ₄ -in
8-ft, 0-in Tall	32-in wide	33-½-in x 97-½-in	47-in x 97-½-in	60-½-in x 97-½-in	66-¼-in x 97-½-in	N/A	N/A
	36-in wide	37-½-in x 97-½-in	51-in x 97-½-in	64-½-in x 97-in	74-¼-in x 97-½-in	64-½-in x 112- ¹ / ₈ -in	64-½-in x 111- ³ / ₈ -in

Above dimensions are for inswing boxed sill units with 12-in sidelites. For 14-in sidelites, add 2-in per sidelite to unit width. Therma-Tru recommends a rough opening size ½-in larger in height and ¾-in larger in width than actual unit size. An additional allowance may be required for carpet shim. See store associate for special order sizing (½-in to 5-in cut-down, from bottom of door).

Opaque & Clear Glass Doors



6-Panel⁽⁴⁾ 6



Craftsman



2-Panel
Square Top 6



2-Panel
Soft Arch 6



2-Panel
Soft Arch
Plank 6



9-Lite
Door⁽⁵⁾ 6



1-Lite
Craftsman⁽⁶⁾ 6



6-Lite
Craftsman⁽⁶⁾



Full
Sidelite⁽⁶⁾ 6



4-Lite
Sidelite⁽⁶⁾ 6



3-Lite⁽⁵⁾ 6



8-ft Tall
6-Panel⁽⁴⁾ 6



8-ft Tall
2-Panel
Square Top 6



8-ft Tall
2-Panel
Soft Arch 6



8-ft Tall
2-Panel
Soft Arch
Plank 6



8-ft Tall
6-Lite
Craftsman⁽⁶⁾

(3) Actual Unit Size (4) Available in Mahogany Collection, Oak Collection & Smooth Surface Collection (5) Fixed external white grilles (6) Low-E 6 WBDR / HVHZ options