



# CTI COMPANIES, LLC

Quotation:

Phone:

248-698-6900

Fax:

1-248-694-2001

5122 RICHFIELD ROAD

FLINT, MI 48506

Quote Name:

14935 Westwood - Wood Units

Quote #:

SQLBQ000031\_1

User Name:

Ed Wenz

Cutoff Order Day - Thursday 12 P.M. CST

Quoted For:

State Lead Program

Ship-To:

CTI COMPANIES, LLC

US

Prepared By:

Ed Wenz

wenz\_ed@yahoo.com

Created On:

11/6/2020

Available To:

2/4/2021

## Quote Information

Total Value:

Status:

Open

Header:

Terms:

Pricing:

All terms and conditions of this quote, including units, quantities, and accessories, are verified and accepted by the undersigned for purchase.

Accepted By

Date

Po#

Line	Label	Quantity	UOM	Part Number	Unit	Extended
1	Livingroom 2	2	EA	Quaker Unit		

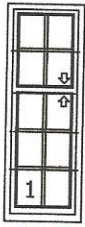

\*\* Viewed From Exterior \*\*

Series: Historic Fit (No Pocket Board)

Exact Size: 23 5/8 X 65 3/4 Outer Perimeter: 23 5/8 X 65 3/4

Color:White,Paint Type:2604,Interior Finish:Natural Finish,

Glass:EnergyBasic (Dual Silver),Argon Filled,

Muntin:SDL-7/8" MBG-916 - EXT- CE-13993 / BG-5/8 / INT - 06017,

Hardware:Gold,Sash:Sweep Lock,

Jamb Liner:Beige,Jamb Liner Cover Exterior:Yes,Lift Assist:Pull Handle Bottom Only,

Screen:Full Screen,Material:BetterVue (TM),Ship:Screen With Product,

Depth:4 3/4" Frame Depth,Ext. Casing16040 Trim Kit,Factory Apply Ext Casing: Yes, Ext. Subsill16040 Trim Kit,Factory Apply Ext Subsill: Yes, Perimeter Acc Color:White,

Unit:1-Double Hung No Plough Exact Size: 23 5/8 X 65 3/4,BarSet - From Bottom:60\_40,NOT Egress,

NFRC - U-Factor:0.31SHGC:0.26VT:0.44AL:≤0.3CR:55

Rating: R-50

Trim Kit Included For Sill Only

Top Glass:Cardinal LowE 272 - DSB / Clear - DSB,Strength:Annealed Glass

Bottom Glass:Cardinal LowE 272 - DSB / Clear - DSB,Strength:Annealed Glass

Overall Rating: DP-50

Sqft 10.79

Total Weight 52 lbs.

Perimeter Acc Lead Time 2.5 Working Days - Exterior Casing 1.5 Working Days - Exterior Subsill 1 Working Day

Applied Grid Lead Time 3 Working Days

2	Livingroom 2	1	EA	Quaker Unit		
---	--------------	---	----	-------------	--	--

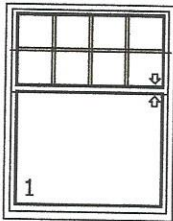

\*\* Viewed From Exterior \*\*

Series: Historic Fit (No Pocket Board)

Exact Size: 51 5/8 X 65 3/4 Outer Perimeter: 51 5/8 X 65 3/4

Color:White,Paint Type:2604,Interior Finish:Natural Finish,

Glass:EnergyBasic (Dual Silver),Argon Filled,

Muntin:SDL-7/8" MBG-916 - EXT- CE-13993 / BG-5/8 / INT - 06017,

Hardware:Gold,Sash:Sweep Lock,

Jamb Liner:Beige,Jamb Liner Cover Exterior:Yes,Lift Assist:Pull Handle Bottom Only,

Screen:Full Screen,Material:BetterVue (TM),Ship:Screen With Product,

Depth:4 3/4" Frame Depth,Ext. Casing16040 Trim Kit,Factory Apply Ext Casing: Yes, Ext. Subsill16040 Trim Kit,Factory Apply Ext Subsill: Yes, Perimeter Acc Color:White,

Unit:1-Double Hung No Plough Exact Size: 51 5/8 X 65 3/4,BarSet - From Bottom:60\_40,NOT Egress,

NFRC - U-Factor:0.31SHGC:0.26VT:0.44AL:≤0.3CR:55

Rating: DP-20 \*

Trim Kit Included For Sill Only

Top Glass:Cardinal LowE 272 - DSB / Clear - DSB,Strength:Annealed Glass

Bottom Glass:Cardinal LowE 272 - DSB / Clear - DSB,Strength:Annealed Glass

Overall Rating: DP-20

Sqft 23.57

Total Weight 101 lbs.

Perimeter Acc Lead Time 2.5 Working Days - Exterior Casing 1.5 Working Days - Exterior Subsill 1 Working Day

Applied Grid Lead Time 3 Working Days

3	Livingroom 7	2	EA	Quaker Unit		
---	--------------	---	----	-------------	--	--

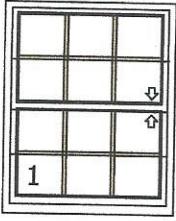

\*\* Viewed From Exterior \*\*

Series: Historic Fit (No Pocket Board)

Exact Size: 43 5/8 X 53 3/4 Outer Perimeter: 43 5/8 X 53 3/4

Color:White,Paint Type:2604,Interior Finish:Natural Finish,

Glass:EnergyBasic (Dual Silver),Argon Filled,

Muntin:SDL-7/8" MBG-916 - EXT- CE-13993 / BG-5/8 / INT - 06017,

Hardware:Gold,Sash:Sweep Lock,

Jamb Liner:Beige,Jamb Liner Cover Exterior:Yes,Lift Assist:Pull Handle Bottom Only,

Screen:Full Screen,Material:BetterVue (TM),Ship:Screen With Product,

Depth:4 3/4" Frame Depth,Ext. Casing16040 Trim Kit,Factory Apply Ext Casing: Yes, Ext. Subsill16040 Trim Kit,Factory Apply Ext Subsill: Yes, Perimeter Acc Color:White,

Unit:1-Double Hung No Plough Exact Size: 43 5/8 X 53 3/4,NOT Egress,

NFRC - U-Factor:0.31SHGC:0.26VT:0.44AL:≤0.3CR:55

Rating: DP-40 \*

Trim Kit Included For Sill Only

Top Glass:Cardinal LowE 272 - DSB / Clear - DSB,Strength:Annealed Glass

Bottom Glass:Cardinal LowE 272 - DSB / Clear - DSB,Strength:Annealed Glass

Overall Rating: DP-40

Sqft 16.28

Total Weight 73 lbs.

Perimeter Acc Lead Time 2.5 Working Days - Exterior Casing 1.5 Working Days - Exterior Subsill 1 Working Day

Applied Grid Lead Time 3 Working Days

4 Diningroom

2 EA

Quaker Unit

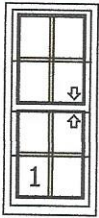

\*\* Viewed From Exterior \*\*

Series: Historic Fit (No Pocket Board)

Exact Size: 23 5/8 X 53 1/2 Outer Perimeter: 23 5/8 X 53 1/2

Color:White,Paint Type:2604,Interior Finish:Natural Finish,

Glass:EnergyBasic (Dual Silver),Argon Filled,

Muntin:SDL-7/8" MBG-916 - EXT- CE-13993 / BG-5/8 / INT - 06017,

Hardware:Gold,Sash:Sweep Lock,

Jamb Liner:Beige,Jamb Liner Cover Exterior:Yes,Lift Assist:Pull Handle Bottom Only,

Screen:Full Screen,Material:BetterVue (TM),Ship:Screen With Product,

Depth:4 3/4" Frame Depth,Ext. Casing16040 Trim Kit,Factory Apply Ext Casing: Yes, Ext. Subsill16040 Trim Kit,Factory Apply Ext

Subsill: Yes, Perimeter Acc Color:White,

Unit:1-Double Hung No Plough Exact Size: 23 5/8 X 53 1/2,NOT Egress,

NFRC - U-Factor:0.31SHGC:0.26VT:0.44AL:≤0.3CR:55

Rating: R-50

Trim Kit Included For Sill Only

Top Glass:Cardinal LowE 272 - DSB / Clear - DSB,Strength:Annealed Glass

Bottom Glass:Cardinal LowE 272 - DSB / Clear - DSB,Strength:Annealed Glass

Overall Rating: DP-50

Sqft 8.78

Total Weight 44 lbs.

Perimeter Acc Lead Time 2.5 Working Days - Exterior Casing 1.5 Working Days - Exterior Subsill 1 Working Day

Applied Grid Lead Time 3 Working Days

5 Kitchen

1 EA

Quaker Unit

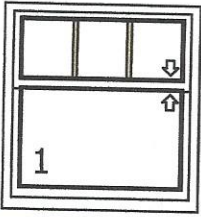

\*\* Viewed From Exterior \*\*

**Series:** Historic Fit (No Pocket Board)  
**Exact Size:** 39 5/8 X 41 3/8 **Outer Perimeter:** 39 5/8 X 41 3/8  
**Color:**White,**Paint Type:**2604,**Interior Finish:**Natural Finish,  
**Glass:**EnergyBasic (Dual Silver),Argon Filled,  
**Muntin:**SDL-7/8" MBG-916 - EXT- CE-13993 / BG-5/8 / INT - 06017,  
**Hardware:**Gold,**Sash:**Sweep Lock,  
**Jamb Liner:**Beige,**Jamb Liner Cover Exterior:**Yes,**Lift Assist:**Pull Handle Bottom Only,  
**Screen:**Full Screen,**Material:**BetterVue (TM),**Ship:**Screen With Product,  
**Depth:**4 3/4" Frame Depth,**Ext. Casing**16040 Trim Kit,**Factory Apply Ext Casing:** Yes, **Ext. Subsill**16040 Trim Kit,**Factory Apply Ext Subsill:** Yes, **Perimeter Acc Color:**White,

**Unit:**1-Double Hung No Plough **Exact Size:** 39 5/8 X 41 3/8,**BarSet - From Bottom:**60\_40,**NOT Egress,**  
**NFRC - U-Factor:**0.31**SHGC:**0.26**VT:**0.44**AL:**≤0.3**CR:**55  
**Rating:** R-50 \*  
 Trim Kit Included For Sill Only  
**Top Glass:**Cardinal LowE 272 - DSB / Clear - DSB,**Strength:**Annealed Glass  
**Bottom Glass:**Cardinal LowE 272 - DSB / Clear - DSB,**Strength:**Annealed Glass  
**Overall Rating:** DP-50  
 Sqft 11.39  
 Total Weight 54 lbs.  
 Perimeter Acc Lead Time 2.5 Working Days - Exterior Casing 1.5 Working Days - Exterior Subsill 1 Working Day  
 Applied Grid Lead Time 3 Working Days

6	1st Flr Bath	1	EA	Quaker Unit
---	--------------	---	----	-------------

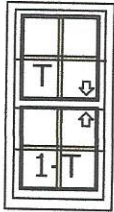

\*\* Viewed From Exterior \*\*

**Series:** Historic Fit (No Pocket Board)  
**Exact Size:** 23 5/8 X 45 3/4 **Outer Perimeter:** 23 5/8 X 45 3/4  
**Color:**White,**Paint Type:**2604,**Interior Finish:**Natural Finish,  
**Glass:**LowE/Obscure (Dual Silver+Obscure),Tempered,Argon Filled,  
**Muntin:**SDL-7/8" MBG-916 - EXT- CE-13993 / BG-5/8 / INT - 06017,  
**Hardware:**Gold,**Sash:**Sweep Lock,  
**Jamb Liner:**Beige,**Jamb Liner Cover Exterior:**Yes,**Lift Assist:**Pull Handle Bottom Only,  
**Screen:**Full Screen,**Material:**BetterVue (TM),**Ship:**Screen With Product,  
**Depth:**4 3/4" Frame Depth,**Ext. Casing**16040 Trim Kit,**Factory Apply Ext Casing:** Yes, **Ext. Subsill**16040 Trim Kit,**Factory Apply Ext Subsill:** Yes, **Perimeter Acc Color:**White,

**Unit:**1-Double Hung No Plough **Exact Size:** 23 5/8 X 45 3/4,**NOT Egress,**  
**NFRC - U-Factor:**0.31**SHGC:**0.26**VT:**0.44**AL:**≤0.3**CR:**55  
**Rating:** R-50  
 Trim Kit Included For Sill Only  
**Top Glass:**Cardinal LowE 272 - DSB / Obscure - Pattern 62 - DSB,**Strength:**Tempered Glass  
**Bottom Glass:**Cardinal LowE 272 - DSB / Obscure - Pattern 62 - DSB,**Strength:**Tempered Glass  
**Overall Rating:** DP-50  
 Sqft 7.51  
 Total Weight 38 lbs.  
 Perimeter Acc Lead Time 2.5 Working Days - Exterior Casing 1.5 Working Days - Exterior Subsill 1 Working Day  
 Applied Grid Lead Time 3 Working Days

7	Stair Case	1	EA	Quaker Unit
---	------------	---	----	-------------

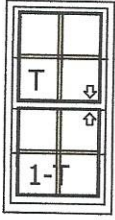

\*\* Viewed From Exterior \*\*

Series: Historic Fit (No Pocket Board)

Exact Size: 27 5/8 X 53 3/4 Outer Perimeter: 27 5/8 X 53 3/4

Color:White,Paint Type:2604,Interior Finish:Natural Finish,  
Glass:Custom,Argon Filled,

Muntin:SDL-7/8" MBG-916 - EXT- CE-13993 / BG-5/8 / INT - 06017,

Hardware:Gold,Sash:Sweep Lock,

Jamb Liner:Beige,Jamb Liner Cover Exterior:Yes,Lift Assist:Pull Handle Bottom Only,

Screen:Full Screen,Material:BetterVue (TM),Ship:Screen With Product,

Depth:4 3/4" Frame Depth,Ext. Casing16040 Trim Kit,Factory Apply Ext Casing: Yes, Ext. Subsill16040 Trim Kit,Factory Apply Ext Subsill: Yes, Perimeter Acc Color:White,

Unit:1-Double Hung No Plough Exact Size: 27 5/8 X 53 3/4,NOT Egress,

NFRC - U-Factor:0.31SHGC:0.26VT:0.44AL:≤0.3CR:55

Rating: R-50

Trim Kit Included For Sill Only

Top Glass:Cardinal LowE 272 - DSB / Clear - DSB,Strength:Tempered Glass

Bottom Glass:Cardinal LowE 272 - DSB / Clear - DSB,Strength:Tempered Glass

Overall Rating: DP-50

Sqft 10.31

Total Weight 50 lbs.

Perimeter Acc Lead Time 2.5 Working Days - Exterior Casing 1.5 Working Days - Exterior Subsill 1 Working Day

Applied Grid Lead Time 3 Working Days

8 Bth 2nd Flr

1 EA

Quaker Unit

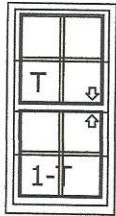

\*\* Viewed From Exterior \*\*

Series: Historic Fit (No Pocket Board)

Exact Size: 27 5/8 X 53 1/2 Outer Perimeter: 27 5/8 X 53 1/2

Color:White,Paint Type:2604,Interior Finish:Natural Finish,

Glass:LowE/Obscure (Dual Silver+Obscure),Tempered,Argon Filled,

Muntin:SDL-7/8" MBG-916 - EXT- CE-13993 / BG-5/8 / INT - 06017,

Hardware:Gold,Sash:Sweep Lock,

Jamb Liner:Beige,Jamb Liner Cover Exterior:Yes,Lift Assist:Pull Handle Bottom Only,

Screen:Full Screen,Material:BetterVue (TM),Ship:Screen With Product,

Depth:4 3/4" Frame Depth,Ext. Casing16040 Trim Kit,Factory Apply Ext Casing: Yes, Ext. Subsill16040 Trim Kit,Factory Apply Ext Subsill: Yes, Perimeter Acc Color:White,

Unit:1-Double Hung No Plough Exact Size: 27 5/8 X 53 1/2,NOT Egress,

NFRC - U-Factor:0.31SHGC:0.26VT:0.44AL:≤0.3CR:55

Rating: R-50

Trim Kit Included For Sill Only

Top Glass:Cardinal LowE 272 - DSB / Obscure - Pattern 62 - DSB,Strength:Tempered Glass

Bottom Glass:Cardinal LowE 272 - DSB / Obscure - Pattern 62 - DSB,Strength:Tempered Glass

Overall Rating: DP-50

Sqft 10.26

Total Weight 50 lbs.

Perimeter Acc Lead Time 2.5 Working Days - Exterior Casing 1.5 Working Days - Exterior Subsill 1 Working Day

Applied Grid Lead Time 3 Working Days

9 2nd Flr Brms

3 EA

Quaker Unit

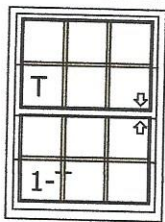

\*\* Viewed From Exterior \*\*

Series: Historic Fit (No Pocket Board)

Exact Size: 39 5/8 X 53 1/4 Outer Perimeter: 39 5/8 X 53 1/4

Color:White,Paint Type:2604,Interior Finish:Natural Finish,  
 Glass:Custom,Argon Filled,  
 Muntin:SDL-7/8" MBG-916 - EXT- CE-13993 / BG-5/8 / INT - 06017,  
 Hardware:Gold,Sash:Sweep Lock,  
 Jamb Liner:Beige,Jamb Liner Cover Exterior:Yes,Lift Assist:Pull Handle Bottom Only,  
 Screen:Full Screen,Material:BetterVue (TM),Ship:Screen With Product,  
 Depth:4 3/4" Frame Depth,Ext. Casing16040 Trim Kit,Factory Apply Ext Casing: Yes, Ext. Subsill16040 Trim Kit,Factory Apply Ext  
 Subsill: Yes, Perimeter Acc Color:White,

Unit:1-Double Hung No Plough Exact Size: 39 5/8 X 53 1/4,NOT Egress,  
 NFRC - U-Factor:0.31SHGC:0.26VT:0.44AL:≤0.3CR:55

Rating: R-50 \*

Trim Kit Included For Sill Only

Top Glass:Cardinal LowE 272 - DSB / Clear - DSB,Strength:Tempered Glass

Bottom Glass:Cardinal LowE 272 - DSB / Clear - DSB,Strength:Tempered Glass

Overall Rating: DP-50

Sqft 14.65

Total Weight 67 lbs.

Perimeter Acc Lead Time 2.5 Working Days - Exterior Casing 1.5 Working Days - Exterior Subsill 1 Working Day

Applied Grid Lead Time 3 Working Days

10	2nd Flr Brms	3	EA	Quaker Unit
----	--------------	---	----	-------------

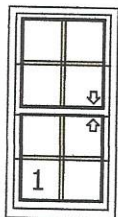

\*\* Viewed From Exterior \*\*

Series: Historic Fit (No Pocket Board)

Exact Size: 27 5/8 X 53 1/4 Outer Perimeter: 27 5/8 X 53 1/4

Color:White,Paint Type:2604,Interior Finish:Natural Finish,  
 Glass:EnergyBasic (Dual Silver),Argon Filled,  
 Muntin:SDL-7/8" MBG-916 - EXT- CE-13993 / BG-5/8 / INT - 06017,  
 Hardware:Gold,Sash:Sweep Lock,  
 Jamb Liner:Beige,Jamb Liner Cover Exterior:Yes,Lift Assist:Pull Handle Bottom Only,  
 Screen:Full Screen,Material:BetterVue (TM),Ship:Screen With Product,  
 Depth:4 3/4" Frame Depth,Ext. Casing16040 Trim Kit,Factory Apply Ext Casing: Yes, Ext. Subsill16040 Trim Kit,Factory Apply Ext  
 Subsill: Yes, Perimeter Acc Color:White,

Unit:1-Double Hung No Plough Exact Size: 27 5/8 X 53 1/4,NOT Egress,

NFRC - U-Factor:0.31SHGC:0.26VT:0.44AL:≤0.3CR:55

Rating: R-50

Trim Kit Included For Sill Only

Top Glass:Cardinal LowE 272 - DSB / Clear - DSB,Strength:Annealed Glass

Bottom Glass:Cardinal LowE 272 - DSB / Clear - DSB,Strength:Annealed Glass

Overall Rating: DP-50

Sqft 10.22

Total Weight 49 lbs.

Perimeter Acc Lead Time 2.5 Working Days - Exterior Casing 1.5 Working Days - Exterior Subsill 1 Working Day

Applied Grid Lead Time 3 Working Days

11		1	EA	Order Items
----	--	---	----	-------------

Quote Name: 14935 Westwood - Wood Units

Quote #: SQLBQ000031\_1

Weighted Average Rating  
U-Factor:0.31  
SHGC:0.26  
VT:0.44  
Total Sqft : 209.35  
Total Windows : 17  
Total Drops : 34  
Total Weight : 979

Project Data Sheet

The purpose of this document is to protect Quaker and your lien rights in the event of non-payment

<p><b>New Construction</b> <input type="checkbox"/>      <b>Replacement</b> <input type="checkbox"/></p> <p><b>1) Project Name:</b> _____                  Address: _____                  City: _____                  State: _____                  Zip: _____                  County of Property: _____</p> <p><b>2) Ship To Information:</b>                  Address: _____                  City: _____                  State: _____                  Zip: _____                  Jobsite/Delivery Contact: _____                  Phone: _____                  Email: _____</p> <p><b>3) Your Status in Project:</b>  <input type="checkbox"/> Owner  <input type="checkbox"/> General Contractor  <input type="checkbox"/> Subcontractor  <input type="checkbox"/> Supplier to Sub-Contractor  <input type="checkbox"/> Supplier to G. C.  <input type="checkbox"/> Other (please describe): _____</p> <p><b>4) Project Owner:</b> _____                  Address: _____                  City: _____                  State: _____                  Zip: _____                  Contact Name: _____                  Phone: _____                  Email: _____</p> <p><b>5) General Contractor:</b> _____                  Address: _____                  City: _____                  State: _____                  Zip: _____                  Contact Name: _____                  Phone: _____                  Email: _____</p> <p><b>6) Sub-Contractor:</b> _____                  Address: _____                  City: _____                  State: _____                  Zip: _____                  Contact Name: _____                  Phone: _____                  Email: _____</p>	<p><b>7) Order Terms</b>                  Payment Terms from Quaker: _____                  P.O. Number: _____                  Billing Cycle: _____  <input type="checkbox"/> Direct Payment  <input type="checkbox"/> Joint Check Agreement (please attach)</p> <p><b>8) Project Description</b> (select all that apply):  <input type="checkbox"/> Tax Exempt Organization      <input type="checkbox"/> Enterprise Zone  <input type="checkbox"/> Privately Owned                      <input type="checkbox"/> Public Works  <input type="checkbox"/> Local, City or State                      <input type="checkbox"/> Federal                  Contract #: _____                  Project #: _____                  Exemption # (provide documentation): _____</p> <p><b>9) Project Notices:</b>                  Has the GC or owner Filed A notice that the project has commenced?                  Yes <input type="checkbox"/>                  No <input type="checkbox"/></p> <p><b>10) Payment Bond:</b> <input type="checkbox"/> Yes <input type="checkbox"/> No                  Payment bond #: _____                  Bonding Company: _____                  City: _____                  State: _____                  Contact Name: _____                  Phone: _____                  Email: _____</p> <p><b>11) Additional Information</b>                  Architect: _____                  Contact Name: _____                  Phone: _____                  Email: _____                  Title Company: _____                  Contact Name: _____                  Phone: _____                  Email: _____                  Lender: _____                  Contact Name: _____                  Phone: _____                  Email: _____</p>
---	--





**Terms:**

- This quote is based on the products as listed. Customer must review quote and verify quantities, sizes, types, finishes, glazing, and adherence to specifications and job requirements and any relevant local or national codes.
- All prices are subject to change at any time if quantities, product, or other terms and conditions that are not part of the original quotation change or if the buyer requests extended delivery dates.
- This quote is an offer by Quaker Window Products Co. ("Quaker"), a Missouri corporation, to sell to the Customer the products described herein at the prices indicated, subject to the terms and conditions stated in this document, including the referenced Quaker warranty and the limitations of liability described therein. Unless otherwise agreed, this offer shall expire after the quote availability date listed on the quote. In order to accept such offer, and before Quaker begins to fabricate such products, Customer must:
  1. Review and approve this quote;
  2. Provide any additional details or information Quaker requires regarding the job or the Customer;
  3. If applicable, complete and submit a credit application subject to approval by Quaker's credit department; and
  4. If applicable, submit approved Shop Drawings which are incorporated into the order.
- Quaker's entry of a sales order will serve to acknowledge completion of these steps. Any purchase order or other document that Customer may use to indicate acceptance of this quote, shall be considered for Customer's internal purposes only, and notwithstanding any language to the contrary in any such document, any resulting order shall remain subject to the governing terms and conditions stated in this quote. Quaker expressly objects to, and does not accept, any conflicting, modified, or additional terms or conditions proposed by Customer unless such proposed terms and conditions are specifically approved in writing by Quaker's credit department, legal counsel, or an appropriate officer of the company.
- TAXES: Unless otherwise indicated, sales or use taxes are not included in this quote. It shall be Customer's responsibility to ensure payment of any applicable state or local sales or use or other taxes, and Customer shall indemnify Quaker against any claimed failure to pay such taxes when due.
- Any lead times provided are estimates only. An estimated delivery date will be established by Quaker and communicated to Customer once the sales order is entered.
- If you request any change to your order after placing your order, then you will be responsible for any actual or reasonably estimated costs incurred by Quaker in processing such change, and Quaker may require submittal of a change order documenting the requested changes.
- WARRANTY: The sale of the quoted products is subject to [Quaker's Limited Warranty for Single-Family Dwellings dated 4/1/2019](#), which contains the relevant manufacturer's warranty and various limitations of liability, is hereby incorporated by reference, and is available at [www.quakerwindows.com/warranty-information/](http://www.quakerwindows.com/warranty-information/). Customer will provide this warranty to the end user as appropriate.
- Undeliverable Product Storage Fee: If Customer is not willing or able to accept delivery of an order that is ready for shipment, then for any delivery delayed by more than 14 calendar days from the estimated delivery date, an undeliverable product storage fee of \$350 per trailer per week will be added to the order, which may be invoiced at that time.
- Delivery & Detainage Fee: Customer is responsible for inspecting and unloading products associated with this order upon delivery. If offloading time is excessive, then Customer will be responsible for payment of detention fees in the amount of \$150 per hour. If Customer's inspection reveals products damaged during shipment, such damage should be photographed at the time of delivery, and must be documented on the delivery ticket.
- Product rating information: Individual units greater than gateway size may have a reduced rating per Quaker's calculations based on AAMA 2502-07 Comparative Analysis Procedure for Window and Door Products. Overall Design Pressure of mulls/assemblies may be less than the computed values of individual units per Quaker's calculations based on AAMA 450-10 Voluntary Performance Rating Method for Mulls/Fenestration Assemblies. Thermal ratings are based on NFRC test size.
- Any vertical or horizontal mulling system is designed for lateral wind loading only and does not provide structural down loading. Headers must be sized to allow for a maximum deflection of 1/8 of an inch. Please consult an architect or engineer for design requirements and building code compliance when combining multiple units together.
- FIELD TESTING: In order to be warranted for performance by Quaker, any field testing of QUAKER products must be conducted as specified in the above-described warranty.
- PRICE ADJUSTMENT: Quaker reserves the right to adjust the pricing described in this quote, or impose an additional surcharge, in the event of any extraordinary increase in any of its costs associated with manufacturing, supplying, or distributing the quoted products after the date of this quote, whether or not such increase arises out of an event of force majeure or a failure of presupposed conditions, upon notice to the Customer at any time prior to Quaker's entry of Customer's order regarding the adjustment or surcharge necessary to defray such increases.
- FORCE MAJEURE: Quaker will not be liable for any nonperformance, delay in performance, or damage that results from any cause beyond Quaker's reasonable control, including, without limitation, any: Act of God; act of the Customer; restraint of government, such as embargo or other trade restrictions or governmental regulations or demands (whether or not later proven to be invalid); fire; flood; accident; strike or other labor disturbance; machinery or equipment breakdown; plant shutdown or slowdown; war; riot; terrorist act; delay in transportation; delays of suppliers or carriers; or inability to obtain necessary labor, materials or manufacturing facilities at customary prices ("Force Majeure Events").

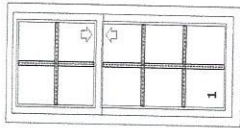

\* T in the drawing denotes Tempered Glass

**Line:** 1  
**Quantity:** 2  
**Color:** White  
**Overall Dim:** 23 5/8 x 65 3/4  
**RO:** 24 3/8 x 66 1/4

**Label:** Livingroom 2  
**Series:** Historic Fit (No Pocket Board)  
**Glass:** EnergyBasic (Dual Silver)  
**DP Rating:** 50  
**Factory Mullied:** Yes

Unit	Option	Value
1	DP Rating	50
	Unit Dim	23 5/8" x 65 3/4"
	Meets Egress	No

**Comments:**

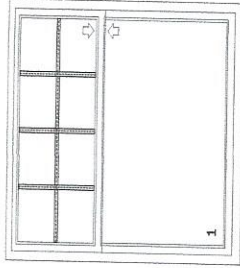

\* T in the drawing denotes Tempered Glass

**Line:** 2  
**Quantity:** 1  
**Color:** White  
**Overall Dim:** 51 5/8 x 65 3/4  
**RO:** 52 3/8 x 66 1/4

**Label:** Livingroom 2  
**Series:** Historic Fit (No Pocket Board)  
**Glass:** EnergyBasic (Dual Silver)  
**DP Rating:** 20  
**Factory Mullied:** Yes

Unit	Option	Value
1	DP Rating	20
	Unit Dim	51 5/8" x 65 3/4"
	Meets Egress	No

**Comments:**

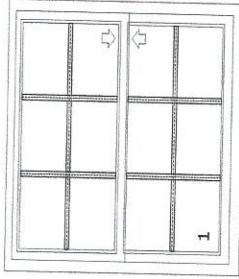

\* T in the drawing denotes Tempered Glass

**Line:** 3  
**Quantity:** 2  
**Color:** White  
**Overall Dim:** 43 5/8 x 53 3/4  
**RO:** 44 3/8 x 54 1/4

**Label:** Livingroom 7  
**Series:** Historic Fit (No Pocket Board)  
**Glass:** EnergyBasic (Dual Silver)  
**DP Rating:** 40  
**Factory Mullied:** Yes

Unit	Option	Value
1	DP Rating	40
	Unit Dim	43 5/8" x 53 3/4"
	Meets Egress	No

**Comments:**



Quaker Window Products  
 504 South Highway 63  
 Freeburg, MO 65035  
 Phone: (800) 347-0438  
[www.quakerwindows.co](http://www.quakerwindows.co)

**Order No:** SQLBQ000031\_1  
**Customer:** CTT COMPANIES, LLC

QUAKER WINDOW PRODUCTS WILL NOT BE RESPONSIBLE FOR FIELD MEASUREMENT, QUANTITIES & INSTALLATION. DESIGN CONTRACTOR MUST VERIFY ALL DIMENSIONS.

**Project Name**  
 14935 Westwood - Wood Units  
**Description**

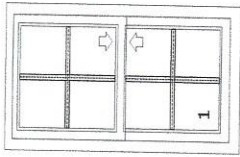

\* T in the drawing denotes Tempered Glass

**Line: 4**  
**Quantity: 2**  
**Color: White**  
**Overall Dim: 23 5/8" x 53 1/2"**  
**RO: 24 3/8" x 54"**  
**Label: Diningroom**  
**Series: Historic Fit (No Pocket Board)**  
**Glass: EnergyBasic (Dual Silver)**  
**DP Rating: 50**  
**Factory Mullid: Yes**

Unit	Option	Value
1	DP Rating	50
	Unit Dim	23 5/8" x 53 1/2"
	Meets Egress	No

**Comments:**

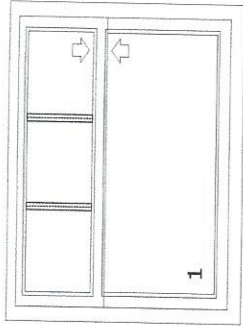

\* T in the drawing denotes Tempered Glass

**Line: 5**  
**Quantity: 1**  
**Color: White**  
**Overall Dim: 39 5/8" x 41 3/8"**  
**RO: 40 3/8" x 41 7/8"**  
**Label: Kitchen**  
**Series: Historic Fit (No Pocket Board)**  
**Glass: EnergyBasic (Dual Silver)**  
**DP Rating: 50**  
**Factory Mullid: Yes**

Unit	Option	Value
1	DP Rating	50
	Unit Dim	39 5/8" x 41 3/8"
	Meets Egress	No

**Comments:**

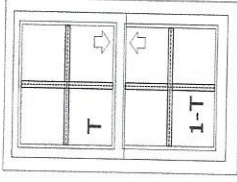

\* T in the drawing denotes Tempered Glass

**Line: 6**  
**Quantity: 1**  
**Color: White**  
**Overall Dim: 23 5/8" x 45 3/4"**  
**RO: 24 3/8" x 46 1/4"**  
**Label: 1st Flr Bath**  
**Series: Historic Fit (No Pocket Board)**  
**Glass: LowE/Obscure (Dual Silver)**  
**DP Rating: 50**  
**Factory Mullid: Yes**

Unit	Option	Value
1	DP Rating	50
	Unit Dim	23 5/8" x 45 3/4"
	Meets Egress	No

**Comments:**



Quaker WindowProducts  
 504 South Highway 63  
 Freeburg, MO 65035  
 Phone: (800) 347-0438

Order No: SQLBQ000031\_1  
 Customer: CTT COMPANIES, LLC

QUAKER WINDOW PRODUCTS WILL NOT BE RESPONSIBLE  
 FOR FIELD MEASUREMENT QUANTITIES & INSTALLATION.  
 DESIGN CONTRACTOR MUST VERIFY ALL DIMENSIONS.

Project Name  
 14935 Westwood - Wood Units  
 Description

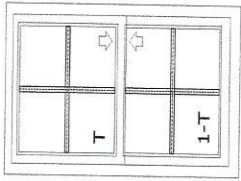

\* T in the drawing denotes Tempered Glass

Line: 7  
 Quantity: 1  
 Color: White  
 Overall Dim: 27 5/8 x 53 3/4  
 RO: 28 3/8 x 54 1/4

Label: Stair Case  
 Series: Historic Fit (No Pocket Board)  
 Glass: Customize  
 DP Rating: 50  
 Factory Mullied: Yes

Unit	Option	Value
1	DP Rating	50
	Unit Dim	27 5/8" x 53 3/4"
	Meets Egress	No

Comments:

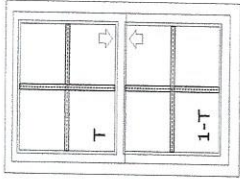

\* T in the drawing denotes Tempered Glass

Line: 8  
 Quantity: 1  
 Color: White  
 Overall Dim: 27 5/8 x 53 1/2  
 RO: 28 3/8 x 54

Label: Bth 2nd Fir  
 Series: Historic Fit (No Pocket Board)  
 Glass: LowE/Obscure (Dual Silver)  
 DP Rating: 50  
 Factory Mullied: Yes

Unit	Option	Value
1	DP Rating	50
	Unit Dim	27 5/8" x 53 1/2"
	Meets Egress	No

Comments:

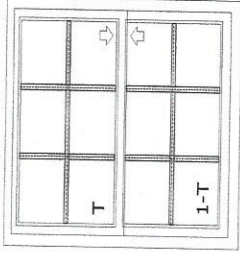

\* T in the drawing denotes Tempered Glass

Line: 9  
 Quantity: 3  
 Color: White  
 Overall Dim: 39 5/8 x 53 1/4  
 RO: 40 3/8 x 53 3/4

Label: 2nd Fir Brms  
 Series: Historic Fit (No Pocket Board)  
 Glass: Customize  
 DP Rating: 50  
 Factory Mullied: Yes

Unit	Option	Value
1	DP Rating	50
	Unit Dim	39 5/8" x 53 1/4"
	Meets Egress	No

Comments:



Quaker WindowProducts  
 504 South Highway 63  
 Freeburg, MO 65035  
 Phone: (800) 347-0438

Order No: SQLBQ000037\_1  
 Customer: CTI COMPANIES, LLC

QUAKER WINDOW PRODUCTS WILL NOT BE RESPONSIBLE  
 FOR FIELD MEASUREMENT, QUANTITIES & INSTALLATION.  
 DESIGN, CONTRACTOR MUST VERIFY ALL DIMENSIONS.

Project Name  
 14935 Westwood - Wood Units  
 Description

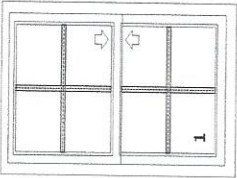

\*T in the drawing denotes Tempered Glass

Line: 10  
 Quantity: 3  
 Color: White  
 Overall Dim: 27 5/8 x 53 1/4  
 RC: 28 3/8 x 53 3/4  
 Label: 2nd Fl Brms  
 Series: Historic Fit (No Pocket Board)  
 Glass: EnergyBasic (Dual Silver)  
 DP Rating: 50  
 Factory Muller: Yes

Unit	Option	Value
1	DP Rating	50
	Unit Dim	27 5/8" x 53 1/4"
	Meets Egress	No

Comments:

Quaker Window Products  
 504 South Highway 83  
 Freeburg, MO 65035  
 Phone: (800) 347-0438  
 www.quakerwindows.co

Order No: SQLBC000031\_1  
 Customer: CTT COMPANIES, LLC

QUAKER WINDOW PRODUCTS WILL NOT BE RESPONSIBLE FOR FIELD MEASUREMENT, QUANTITIES & INSTALLATION. DESIGN, CONTRACTOR MUST VERIFY ALL DIMENSIONS.

Project Name  
 14935 Westwood - Wood Units  
 Description

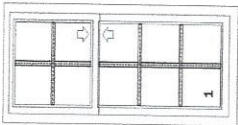

\* T in the drawing denotes Tempered Glass

**Line: 1**  
**Quantity:** 2  
**Color:** White  
**Overall Dim:** 23 5/8 x 65 3/4  
**RO:** 24 3/8 x 66 1/4

**Label:** Livingroom 2  
**Series:** Historic Fit (No Pocket Board)  
**Glass:** EnergyBasic (Dual Silver)  
**DP Rating:** 50  
**Factory Muller:** Yes

Unit	Option	Value
1	DP Rating	50
	Unit Dim	23 5/8" x 65 3/4"
	Meets Egress	No

**Comments:**

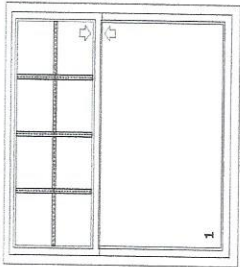

\* T in the drawing denotes Tempered Glass

**Line: 2**  
**Quantity:** 1  
**Color:** White  
**Overall Dim:** 51 5/8 x 65 3/4  
**RO:** 52 3/8 x 66 1/4

**Label:** Livingroom 2  
**Series:** Historic Fit (No Pocket Board)  
**Glass:** EnergyBasic (Dual Silver)  
**DP Rating:** 20  
**Factory Muller:** Yes

Unit	Option	Value
1	DP Rating	20
	Unit Dim	51 5/8" x 65 3/4"
	Meets Egress	No

**Comments:**

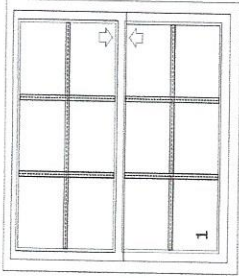

\* T in the drawing denotes Tempered Glass

**Line: 3**  
**Quantity:** 2  
**Color:** White  
**Overall Dim:** 43 5/8 x 53 3/4  
**RO:** 44 3/8 x 54 1/4

**Label:** Livingroom 7  
**Series:** Historic Fit (No Pocket Board)  
**Glass:** EnergyBasic (Dual Silver)  
**DP Rating:** 40  
**Factory Muller:** Yes

Unit	Option	Value
1	DP Rating	40
	Unit Dim	43 5/8" x 53 3/4"
	Meets Egress	No

**Comments:**

Quaker WindowProducts  
 504 South Highway 63  
 Freeburg, MO 65035  
 Phone: (800) 347-0438

Order No: SCLB0000031\_1  
 Customer: CTI COMPANIES, LLC

QUAKER WINDOW PRODUCTS WILL NOT BE RESPONSIBLE  
 FOR FIELD MEASUREMENT, QUANTITIES & INSTALLATION,  
 DESIGN. CONTRACTOR MUST VERIFY ALL DIMENSIONS.

Project Name  
 14935 Westwood - Wood Units  
 Description



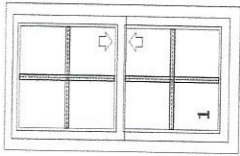

\* T in the drawing denotes Tempered Glass

Line: 4  
 Quantity: 2  
 Color: White  
 Overall Dim: 23 5/8 x 53 1/2  
 RO: 24 3/8 x 54

Unit	Option	Value
1	DP Rating	50
	Unit Dim	23 5/8" x 53 1/2"
	Meets Egress	No

Comments:

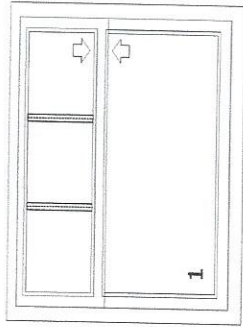

\* T in the drawing denotes Tempered Glass

Line: 5  
 Quantity: 1  
 Color: White  
 Overall Dim: 39 5/8 x 41 3/8  
 RO: 40 3/8 x 41 7/8

Unit	Option	Value
1	DP Rating	50
	Unit Dim	39 5/8" x 41 3/8"
	Meets Egress	No

Comments:

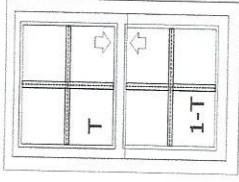

\* T in the drawing denotes Tempered Glass

Line: 6  
 Quantity: 1  
 Color: White  
 Overall Dim: 23 5/8 x 45 3/4  
 RO: 24 3/8 x 46 1/4

Unit	Option	Value
1	DP Rating	50
	Unit Dim	23 5/8" x 45 3/4"
	Meets Egress	No

Comments:

Quaker WindowProducts  
 504 South Highway 53  
 Freeburg, MO 65035  
 Phone: (800) 347-0438  
 www.quakerwindows.co

Order No: SQLBQ000031\_1  
 Customer: CTI COMPANIES, LLC

QUAKER WINDOW PRODUCTS WILL NOT BE RESPONSIBLE  
 FOR FIELD MEASUREMENT, QUANTITIES & INSTALLATION,  
 DESIGN. CONTRACTOR MUST VERIFY ALL DIMENSIONS.

Project Name  
 14935 Westwood - Wood Units  
 Description



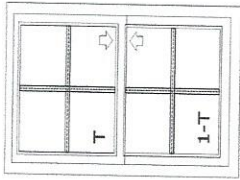

\* T in the drawing denotes Tempered Glass

Line: 7  
 Quantity: 1  
 Color: White  
 Overall Dim: 27 5/8 x 53 3/4  
 RO: 28 3/8 x 54 1/4

Label: Stair Case  
 Series: Historic Fit (No Pocket Board)  
 Glass: Customize  
 DP Rating: 50  
 Factory Mullled: Yes

Unit	Option	Value
1	DP Rating	50
	Unit Dim	27 5/8" x 53 3/4"
	Meets Egress	No

Comments:

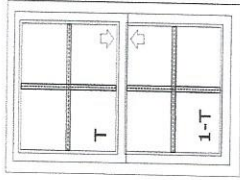

\* T in the drawing denotes Tempered Glass

Line: 8  
 Quantity: 1  
 Color: White  
 Overall Dim: 27 5/8 x 53 1/2  
 RO: 28 3/8 x 54

Label: Blt 2nd Fir  
 Series: Historic Fit (No Pocket Board)  
 Glass: LowE/Obscure (Dual Silver)  
 DP Rating: 50  
 Factory Mullled: Yes

Unit	Option	Value
1	DP Rating	50
	Unit Dim	27 5/8" x 53 1/2"
	Meets Egress	No

Comments:

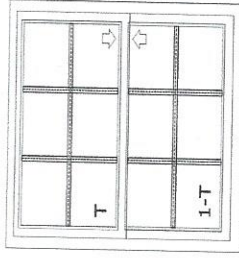

\* T in the drawing denotes Tempered Glass

Line: 9  
 Quantity: 3  
 Color: White  
 Overall Dim: 39 5/8 x 53 1/4  
 RO: 40 3/8 x 53 3/4

Label: 2nd Fir Brms  
 Series: Historic Fit (No Pocket Board)  
 Glass: Customize  
 DP Rating: 50  
 Factory Mullled: Yes

Unit	Option	Value
1	DP Rating	50
	Unit Dim	39 5/8" x 53 1/4"
	Meets Egress	No

Comments:



Quaker WindowProducts  
 504 South Highway 63  
 Freeburg, MO 65035  
 Phone: (800) 347-0438

Order No: SQLBC000031\_1  
 Customer: CTI COMPANIES, LLC

QUAKER WINDOW PRODUCTS WILL NOT BE RESPONSIBLE FOR FIELD MEASUREMENT, QUANTITIES & INSTALLATION. DESIGN, CONTRACTOR MUST VERIFY ALL DIMENSIONS.

Project Name  
 14935 Westwood - Wood Units  
 Description

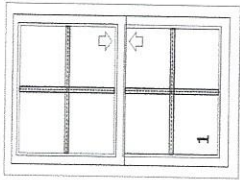

\* T in the drawing denotes Tempered Glass

Line: 10  
 Quantity: 3  
 Color: White  
 Overall Dim: 27 5/8 x 53 1/4  
 RO: 28 3/8 x 53 3/4  
 Label: 2nd Fir Brms  
 Series: Historic Fit (No Pocket Board)  
 Glass: EnergyBasic (Dual Silver)  
 DP Rating: 50  
 Factory Muller: Yes

Unit	Option	Value
1	DP Rating	50
	Unit Dim	27 5/8" x 53 1/4"
	Meets Egress	No

Comments:

Quaker WindowProducts  
 504 South Highway 53  
 Freeburg, MO 65035  
 Phone: (800) 347-0438

Order No: SCLBQ000031\_1  
 Customer: CFI COMPANIES, LLC

QUAKER WINDOW PRODUCTS WILL NOT BE RESPONSIBLE  
 FOR FIELD MEASUREMENT, QUANTITIES & INSTALLATION  
 DESIGN. CONTRACTOR MUST VERIFY ALL DIMENSIONS.

Project Name  
 14935 Westwood - Wood Units  
 Description

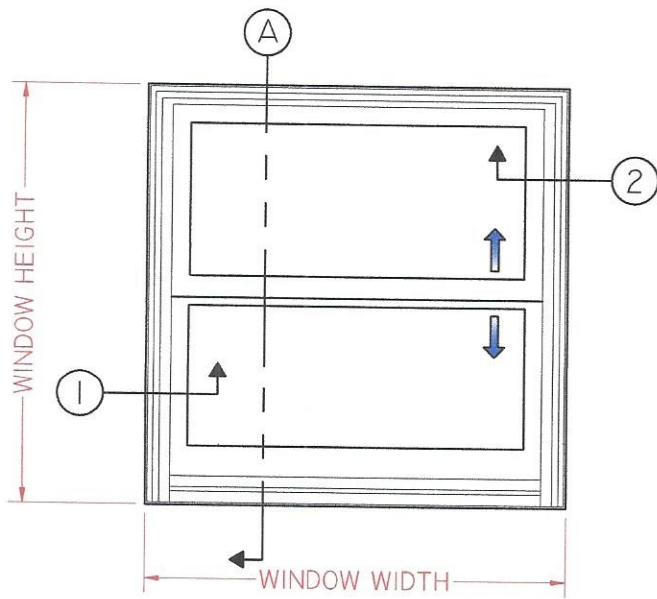
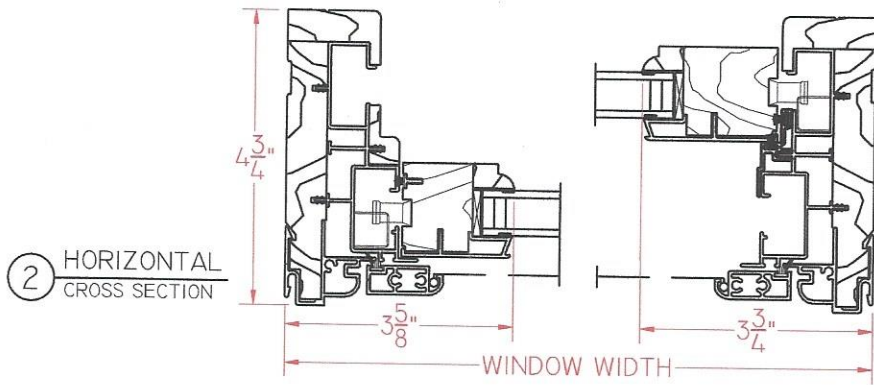

① HORIZONTAL CROSS SECTION

Ⓐ VERTICAL CROSS SECTION

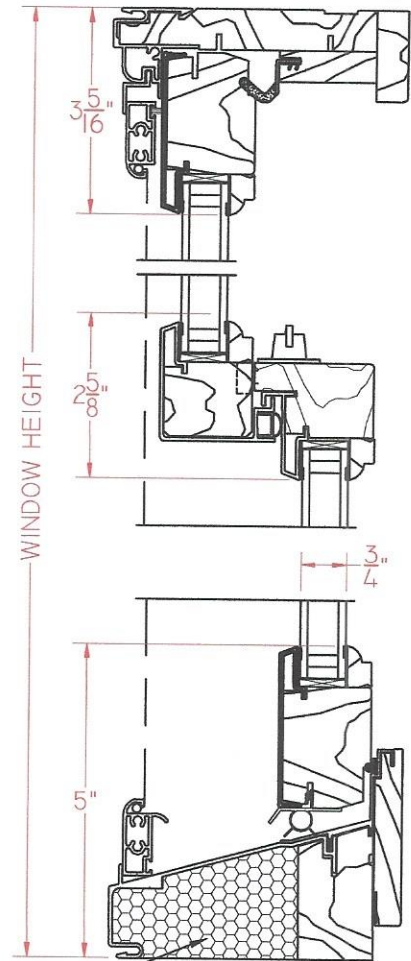

INSTALLER TO FILL CAVITY WITH FIBERGLASS INSULATION BEFORE SETTING WINDOW