

Pergolas



PORCHES
PERGOLAS
DOOR CANOPIES
METAL AWNINGS
FABRIC AWNINGS
WALL SYSTEMS
ACCESS RAMPS
MISC

PORCHES

PERGOLAS

DOOR
CANOPIES

METAL
AWNINGS

FABRIC
AWNINGS

WALL
SYSTEMS

ACCESS
RAMPS

MISC

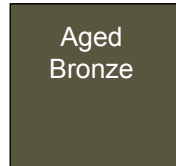
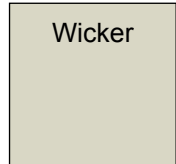
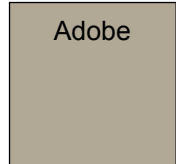

Single Header Pergola Features:

- Roll-formed Aluminum with an embossed wood grain finish provides the look of wood without the hassle. Will not rot, warp or need repainting.
- Single header and posts have adjustable placement, allowing you to locate where needed. Some restrictions will apply in heavy load bearing areas.
- Cut to length headers and rafters that have routed ends with caps factory installed. 3 options available.
- Lattice tubes at 1-1/2" square with standard 3" gap providing 50% shade. Gap can be customized to provide more or less shade.
- Standard posts are an extruded aluminum 3" square. Attached units come with mounting brackets.
- Freestanding units require posts to be embedded in concrete or use optional heavy duty mounting brackets. Optional decorative post surrounds are available. See order chart for details.



PORCHES
PERGOLAS
DOOR CANOPIES
METAL AWNINGS
FABRIC AWNINGS
WALL SYSTEMS
ACCESS RAMPS
MISC

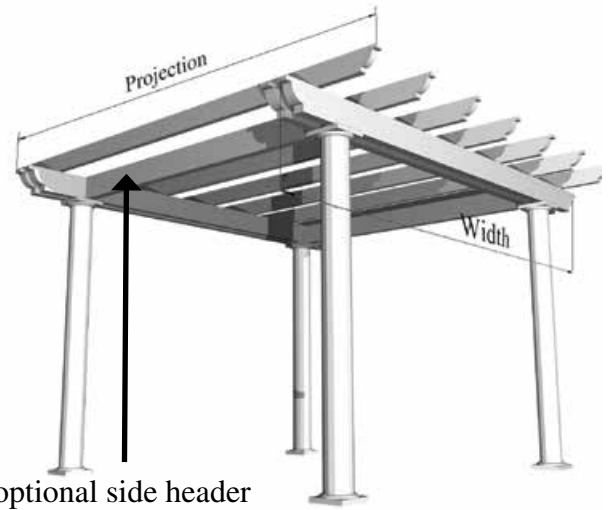
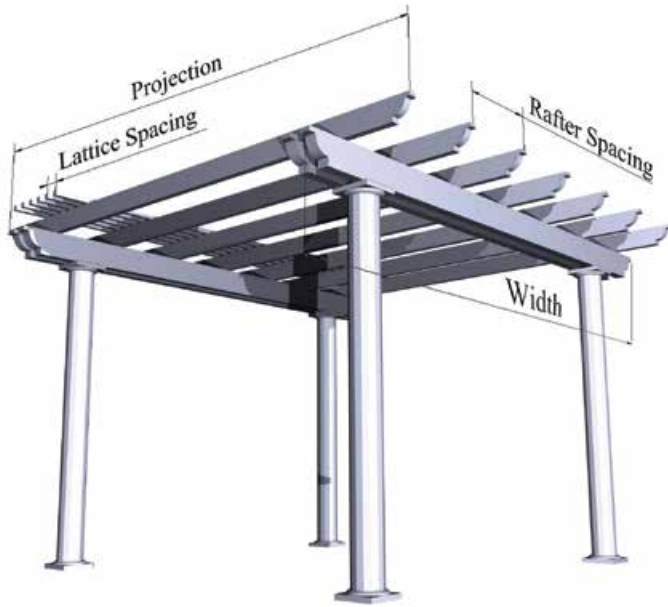

Drawings shown with double header beam

Shown with optional side header

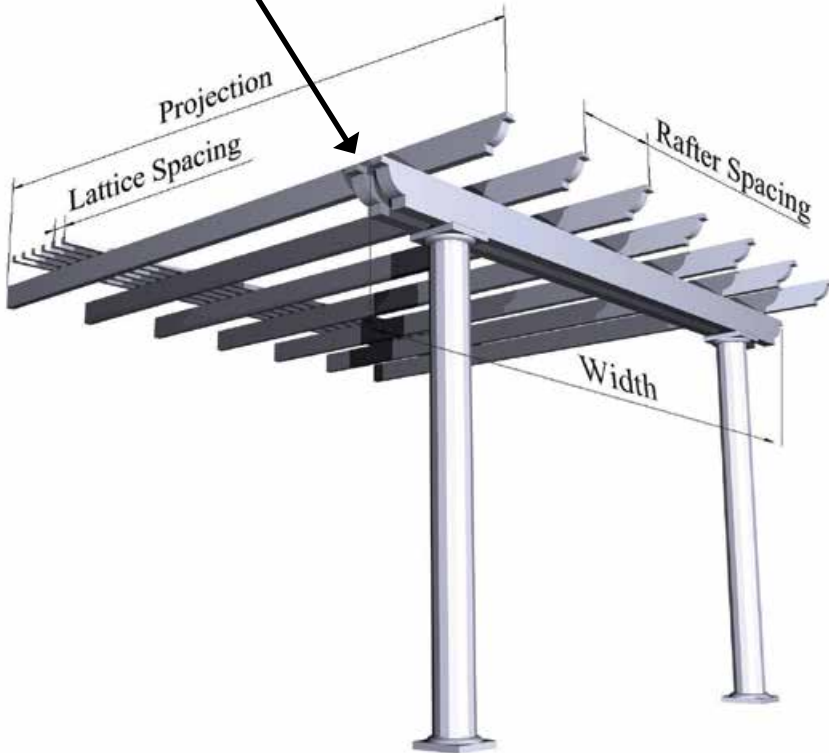

Standard unit comes with 3" post. Optional decor posts available. Square fluted aluminum option shown above.

Customize your Pergola Conceptual Drawings Available

BEAM OPTIONS

- single header beam
 double header beams

CHOICE OF:

- attached to wall
 freestanding

 bury posts in concrete or
 optional HD mounting brackets

DIMENSIONS:

_____ projection (2" x 6-1/2" rafter dimension)
_____ width (3" x 8" header beam dimension)

LATTICE, 1-1/2" SQUARE

create more or less shade with the lattice tubes

- standard 3" gap 1-1/2" gap No lattice
 gap _____

ENGINEERING:

Weight load requirements: 10# 20# 30#
 Standard to 90mph winds - Higher wind loads available.

CHOICE OF POSTS

- 3" square post
 3" sq post & 2"x6" woodlook side plates

Decorative columns, aluminum options

- Have an internal 3" square post
 - Easy snap together assembly
- Caps, bases & columns
- Aluminum, fluted round,
6", 8" or 10" white, adobe, special order wicker
- Aluminum, fluted square,
6", 8", 10" white, adobe, special order wicker
- Aluminum, smooth square,
6", 8", 10" white, adobe, special order wicker

Decorative columns, fiberglass options

- Have an internal 3" square post
 - Must be field painted
 - Require lifting over 3" post on installation
- Fiberglass, smooth round,
6", 8", 10", 12"

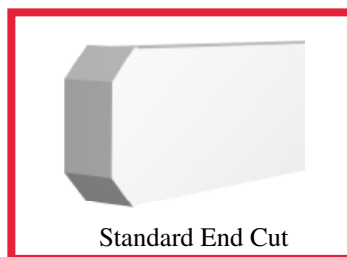

Standard End Cut



Deluxe End



Scallop End

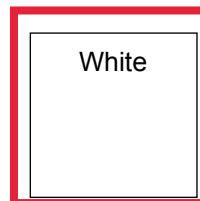

White

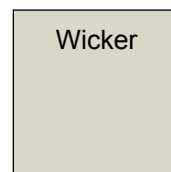

Wicker

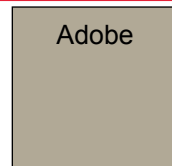

Adobe

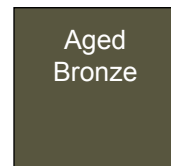

Aged Bronze

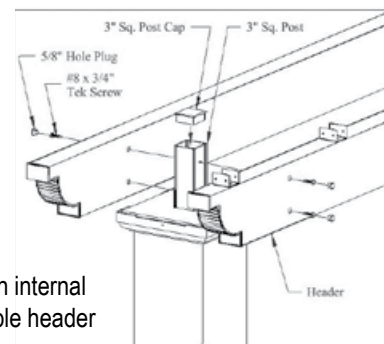

Decorative post surround has an internal 3" sq post that fastens to a double header

PORCHES

PERGOLAS

DOOR
CANOPIES

METAL
AWNINGS

FABRIC
AWNINGS

WALL
SYSTEMS

ACCESS
RAMPS

MISC



PO Box 1290
2 Industrial Dr
Salem IL 62881

INFORMATION
americana.com
sales@americana.com
1-800-851-0865

Cat ID# 16PERGOLA

MADE IN THE USA BY SKILLED CRAFTSMEN

