

STAFF REPORT: 10/12/2022 REGULAR MEETING

PREPARED BY: D. RIEDEN

APPLICATION NUMBER: #22-8066

VIOLATION NUMBER: #500

ADDRESS: 2011 LONGFELLOW

HISTORIC DISTRICT: BOSTON-EDISON

APPLICANT/ PROPERTY OWNER: MARIO MONGINI

DATE OF PROVISIONALLY COMPLETE APPLICATION: 9/19/2022

DATES OF STAFF SITE VISITS: 9/23/22, 8/6/2022, 7/21/2022, 10/26/2021

SCOPE: REPLACE WOOD WINDOWS WITH WOOD AND FIBERGLASS UNITS ALTER PORCH
(WORK COMPLETE WITHOUT APPROVAL)

EXISTING CONDITIONS

Built in 1921, the property at 2011 Longfellow is a 2 ½ story, colonial residence facing northwest. The side gabled asphalt-shingled roof features a single dominant mid-façade gable over the front entrance, flanked by two-arched dormers. The eaves are bracketed, creating a pediment-like formation supported by two-story pilasters on either side of the entrance. The house is clad in red brick with masonry. The symmetrically placed original windows featured true divided light mullions, which have since been replaced by fiberglass windows with between-glass grids, except for the remaining original windows on the third floor. The front porch was originally flanked with brick, raised planter beds, which have since been removed. The original semi-circle steps and front porch railing were removed and replaced with a wing-walled stair that extends the porch away from the house. At a lower in elevation, the front façade’s pilasters now “float” above the porch surface. The wood columns that support the porch roof were replaced with fiberglass and closely resemble the originals. Both the new columns and the pilasters were addressed in the November 2021 Commission decision that included a condition to approve the work of only the columns and pilasters if both were supplied with decorative bases, which have yet to be installed. The porch configuration, step wingwalls and removal of the original porch railing and raised, brick planter beds are in violation and are a part of this application. Security lights installed both on the front pilasters and on the front brick quoins are in violation for installation without approval and are part of this application. A flower bed lines the concrete walk that centers the front lawn.



Site Photo 1, by Staff Sept. 19, 2022: (North) front elevation.



Site Photo 2, designation slide 1980: (North) front elevation.

This property has the following HDC approvals on Detroit Property Information System (DPI).

- November, 2019 COA: Replace asphalt roof with new asphalt roof.
- November, 2021 COA: Repair/repaint all gutters/downspouts, cement rear elevation brick wall and paint surface red, tuck-pointing existing brick where needed, replace 4 rear elevation doors, replace board with fiberglass columns with decorative bases to the columns and pilasters, added soil/fill around garden beds,

demolished rear brick porch, constructed rear elevated wood deck with wood railing, stained, and repair garage doors.

- November 2021 Denial: Replacement of original wood windows with fiberglass sash
- August 2022 Withdrawn: During the Regular HDC Meeting held on August 10, 2022, the applicant withdrew their application regarding scope of work for the windows and the front porch.

This property has the following outstanding violations for work done without approval:

- Wood windows replaced with fiberglass, front porch altered, front steps and railing removed, planter boxes removed and wingwalls added to front steps, installation of front security lights on front pilasters and corners of the house.



Site Photo 3, Google Streetview Aug. 2011: (Northwest) front/side elevation showing front porch alterations made with added wingwalls to front steps. Planter boxes on either side are still in place.

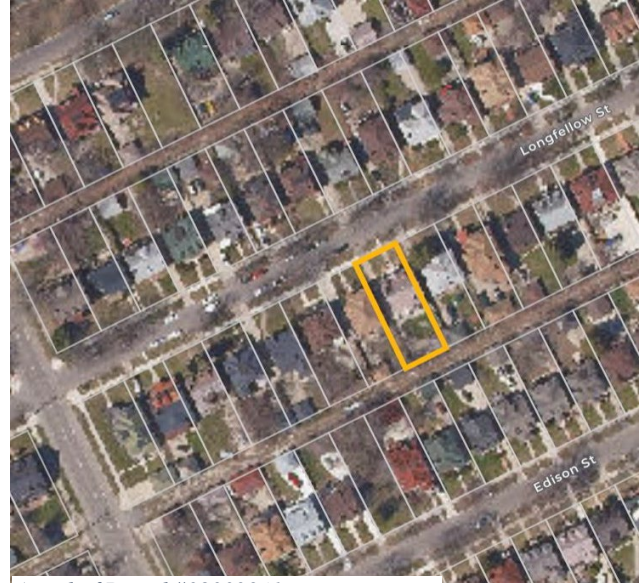

Aerial of Parcel #08002941

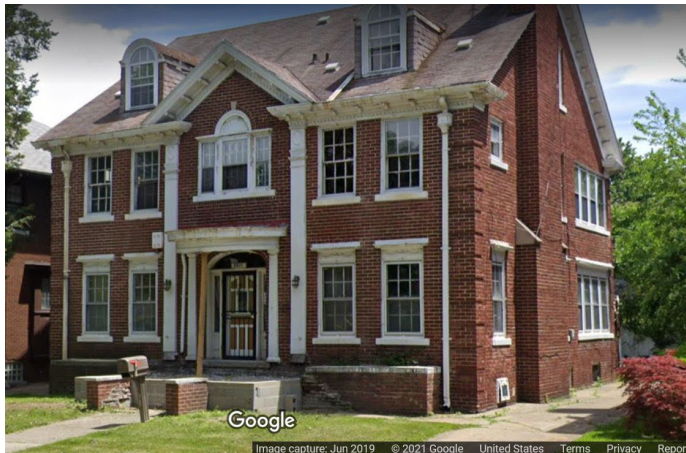

Site Photo 4, Google Streetview June 2019: (Northwest) front/side elevation showing front porch alterations. Planter boxes on either side are still in place, most original windows are still in place, security lights are installed on pilasters.



Site Photo 5, by Applicant Jan 2021: (Southeast) rear elevation showing previous windows.

PROPOSAL

The proposed work consists of two major work items: windows and the front porch, and a minor work item: the security lights installed at the front of the house.

WINDOWS

Except for the basement, there are 60 windows identified on this house, 12 windows are historic and will remain untouched. (See attached window schedule and fig.2.) The replacement of 48 wood windows, which is work completed without approval, was already denied in the HDC Regular meeting of November 2021.



Site Photo 6, by Applicant: (South) rear side elevation showing replaced fiberglass windows on first and second floors and original wood windows on second (middle) and third floors.

- This proposal requests to retain twenty-one (21) of these same windows in their rear and side elevation locations. These fiberglass windows are double-hung with between-glass grids. The proposed window project includes the installation of external wood grids on each of these fiberglass windows with an adhesive two-sided tape in a configuration that mimics the muntin profile of the replaced historic wood windows.
- Five (5) picture windows, which had replaced original double-hung windows, are now proposed to revert to sixteen (16) double-hung aluminum clad wood windows.
- All eleven (11) front elevation windows that were replaced with fiberglass windows are proposed to be replaced with aluminum clad wood, double-hung windows.
- All new aluminum clad wood windows will have simulated divided lights (SDL) in a pattern to match the muntin profile of the replaced historic windows.
- All windows, trim and grids shall be painted white to match the fiberglass windows that remain.

Windows detail:

- Retain twenty-one (21) of the replaced forty-eight (48) windows with Marvin fiberglass “Infinity” windows; Adhere external wood grids on all installed fiberglass windows with double-sided tape to mimic the configuration of the original wood window muntins. Painted white. (See attached window schedule, fig 2, “green” windows 14-19, 23-24, 41-44, 48-56)
- Replace five (5) fiberglass area picture windows and all eleven (11) front elevation fiberglass double-hung windows with aluminum clad wood, double-hung windows with SDL to match historic configuration, painted white. (See attached window schedule, fig 2, “red” windows 1-11, 25-40)
- The front elevation window replacement includes removal of aluminum cladding and restoration of original wood brick molds or replacement in-kind with new brick molds to match the historic if the underlying condition is discovered to be too deteriorated to salvage.

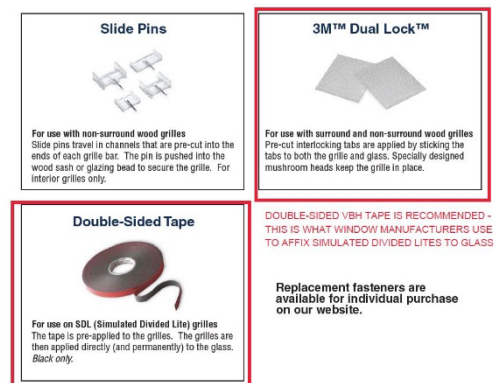

Fig 1, by Applicant: Proposed adhesives for applying wood grid to existing fiberglass window installation.

- The applicant has not decided on which aluminum clad wood product to use: Marvin Signature Ultimate Series or Andersen E Series. (See attached catalogues)
- All basement windows are retained.

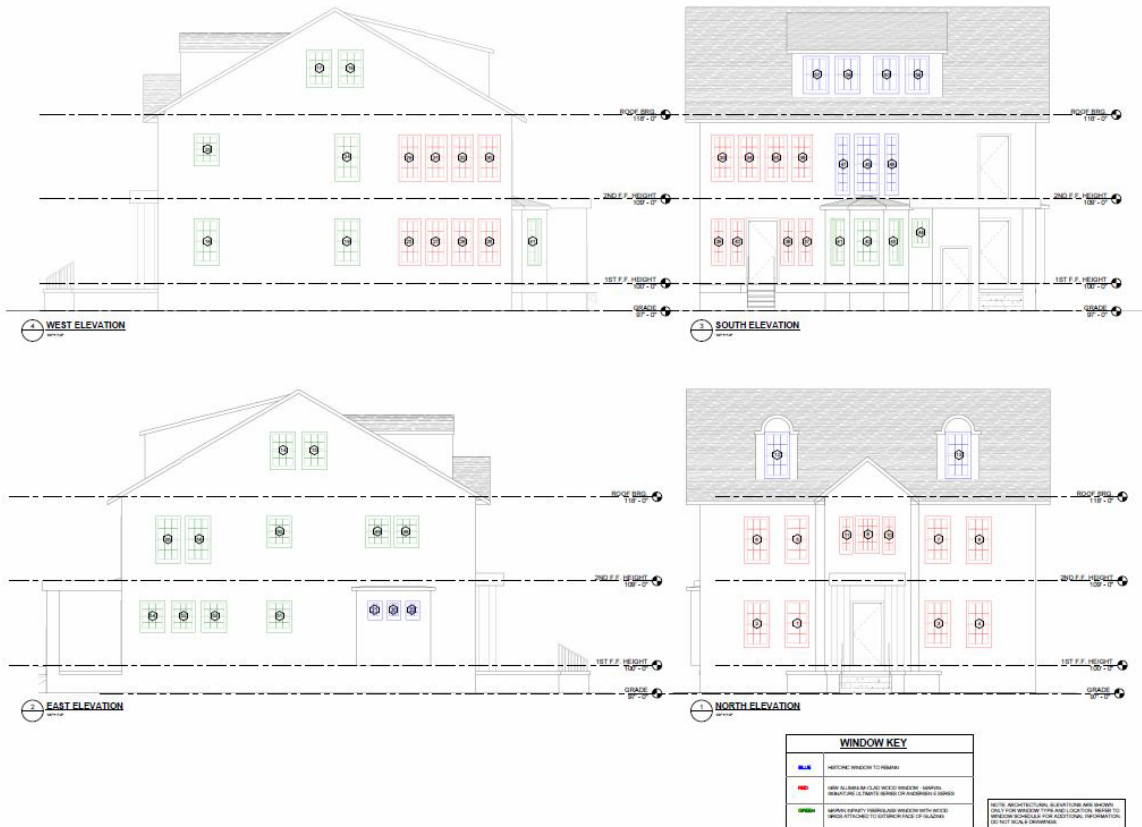

Fig 2, by Applicant: Proposed window schedule, showing the reverting of large picture windows back to the double hung windows at the rear and side (west) elevations and retention of historic windows (blue), replace fiberglass with aluminum clad wood (red), and retaining fiberglass windows (green).

FRONT PORCH

The second work item addresses the outstanding violations for the front porch area of the house. All of this work has been completed without approval. The applicant requests approval for the removal of the front, raised, brick planter boxes, the replacement of the front radial stairs with rectilinear stairs flanked by brick wingwalls, and the reconstruction of the front porch according to the attached drawing/sketch, the removal of the original porch handrails and the installation of new handrails at the new steps. Please note that the front porch configuration was already altered at some time from its original form in the following manner prior to 2009 (see site photo 2 & 3):

- The front porch railings were removed
- The front porch was enlarged by extending the porch forward into the front yard
- The curvilinear steps were altered or replaced by new steps and wingwalls were set on either side
- Precast side steps were added to the porch

These alterations are work complete without approval. The applicant's proposal is based on this new porch configuration and the details are shown in the drawing attached and below.

Front Porch Detail:

- Demolish flanking raised brick planter boxes on either side of the front porch.
- Low-pressure wash and/or gentle acid-based cleaning brick scar marks left from the demolished planter boxes against the front face of the house.

- Install foundation plantings to screen brickwork that was patched when the planter boxes that were removed and to screen the new gas service location at the front of the house.
- Demolish precast concrete side steps on west side of porch
- Reconstruct front porch, steps and wingwalls with concrete cap, 2" overhang and brick siding on porch
- Add Vevor black, 38" wrought-iron handrails to front porch steps.

SECURITY/FRONT PORCH LIGHTS

The third work item is the installation of six (6) security lights at the front elevation of the house: 2 on either side of the front entrance on the pilasters, and 2 each at the front elevation corners on the brick quoins of the house.

Security Lights Detail:

- Install six (6) Lutec sconce security lights (6" l x 4"w x 8"h)
- Material is aluminum, painted black with adjustable LED light direction, 23 watts, 1100 L, 3000 K

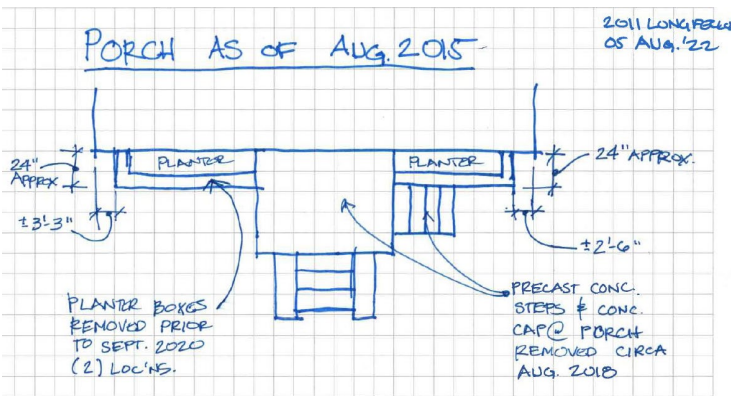

Fig 3, by Applicant: (North) front side plan showing conditions as of Aug 2015, but not the original conditions of the front porch which can be seen in the designation photo, see photo 2.

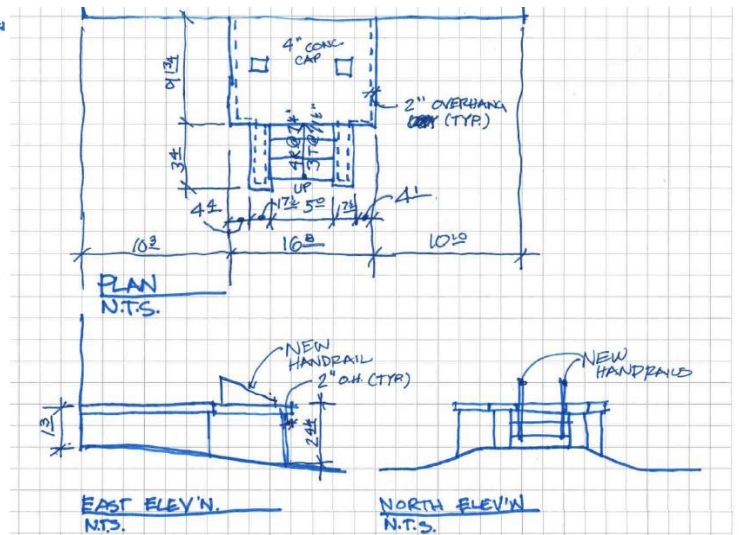

Fig 4, by Applicant: (North) front side plan showing current built conditions and installed handrail elevations for the front steps, work complete.

STAFF OBSERVATIONS AND RESEARCH

- The Boston-Edison Historic District was established in 1974.
- Currently this property is not listed for sale. Staff observed that this property was listed for sale when this property was last before the Commission in August 8, 2022. The owner stated before the Commission in the November 2021 meeting that they were intending to live in the house and not sell it. Staff observed that this property was listed for sale in November 2021 too. (See page 11., [November 10 2021 HDC Regular Meeting Minutes- Approved click here](#))

Windows

- Staff has confirmed that the total number of original wood windows replaced is 48 units.
- In the November 2021 HDC Regular Meeting, the Commission determined that the replacement of the original windows with fiberglass sash was issued a denial for these same fiberglass windows that are proposed to remain. The Commission has already denied the application for these windows in the November 2021 HDC Regular meeting. The part that is different is the application of the wood muntins to these remaining windows to the exterior of the glass.
- Staff has identified that the divided light double-hung windows, and their ribbon formation on the west and rear elevations, are distinctive character-defining features that have been removed without approval, and therefore substantially detracts from and destroys the historic appearance of the building.
- It is staff's opinion that replacement of picture windows (that had previously replaced original double-hung windows) with double-hung windows on the rear and west elevations is appropriate in type and scale as it mimics the original historic, character-defining features of this ribbon formation that was lost when the original windows were removed.
- Staff observed that the installed fiberglass windows have several features that are not appropriate. These larger changes to the original wood windows greatly outweigh the changes in the proposed attempt to add attached grids to the exterior of the windows:
 - the surrounding coil covering the brickmold is large and gives the windows a chunky appearance and with the picture windows, larger seems are found around the perimeter,
 - the meeting rails in the double hung windows do not meet,
 - the dimensions of the header and base of the window do not match the original wood windows,
 - the color of the glass is tinted green/aqua color, and
 - the built-in screens are shadowed, casting a darker shade across the windows.



Site Photo 7, by Applicant: (West) side elevation showing original wood windows.



Site Photo 8 by Applicant: (West) side elevation showing fiberglass picture and double hung windows that replaced the original ribbon of wood, double-hung windows on the first and second floors.

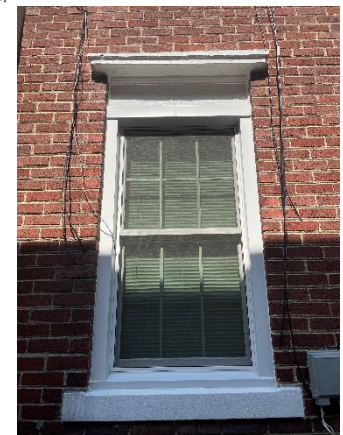

Site Photo 7, by Staff: (West) side elevation showing thick, aluminum coil stock around brick mold and seam, and aqua tinted double-hung window (#18), proposed to remain.

- Although the applicant is proposing to replace all the most visible fiberglass windows on the front elevation with aluminum clad wood windows, staff observed that windows numbered 18 and 23, are to remain as fiberglass and are quite publicly visible as they are in front of the west elevation chimney and visible from the front sidewalk (*see figure 2 and site photos 3, 4 and 7*).
- Staff requested that the applicant provide information regarding the durability of the proposed wood muntins being added to the surface of the existing glass and fiberglass windows with adhesive tape. Staff also requested to applicant to provide any examples of past cases that proves this durability. (*See figure 1*) The applicant provided the following response:

“Fiberglass has a relatively low rate of expansion and contraction (much less than vinyl). The wood will expand and contract with changes in seasons and relative humidity; however, most of the expansion and contraction of the wood will occur in the width-wise direction, NOT the lengthwise direction. Wood only moves 0.01%-0.02% in the lengthwise (longitudinal) direction with changes in moisture content. The manufacturer states on their order form that they size the grilles 1/32" smaller than the daylight opening of the window to accommodate for expansion and contraction with seasonal variations in temperature and humidity. The grilles were selected to provide a traditional profile that mimics the muntin profile of the historic wood windows, while still adding dimension and shadow lines to the glass. We are proposing to affix the muntin bars to the glass with 3M VHB Tape, which is the strongest tape of its kind commercially available, and the same product that manufacturers of new windows utilize to affix muntin bars to glass in the new simulated divided lite windows that they manufacture. Therefore, I would expect the grilles, assuming they are affixed to clean glass and kept properly primed and painted, to last as long as grilles on a newly manufactured, simulated divided lite window. I can reach out to the manufacturer to see if they can provide additional information.”
- It is staff’s opinion that the application of wood muntins on fiberglass windows is not an appropriate application of materials as it attempts to disguise rather than restore historic character-defining features, especially the operation and design of the original ribbon of wood, double-hung windows that were replaced by picture windows. However, staff observed that the application of these muntins occurs in locations of the house that are not as publicly visible, with the exception of windows 23 and 18, which staff noted earlier, is publicly visible.

Front Porch Area

- Staff requested the applicant to provide a planting plan for the proposed foundation planting. As of the date of this report, staff has not received this. Staff cannot verify the quality of the proposed planting.
- The front porch redesign, has changed over several stages in time:
 - The 1980 designation slide shows that the porch was at an elevation where the front façade pilasters met or nearly met the surface of the porch. The porch was originally only as deep as the front face of the porch overhang and supporting columns. The supporting columns were round and tapering to Roman capital at the top. The steps leading the porch were a succession of semi-circles. The porch was flanked by raised brick planters under each set of windows. A metal railing surrounded the porch.
 - Sept 2007 Google streetview shows that the semicircular steps were removed and replaced with wingwalls, the porch was extended forward into the yard, and steps were placed on the west side of the porch with a walkway to the driveway.
 - Aug 2018 Google streetview shows that the front porch, side and front steps were demolished. The raised brick planters remain.
 - June 2019 Google streetview shows that the entire top of the front porch was rebuilt and squared. The brick planters remain.
 - Currently, the brick planters have been removed, leaving scars on the face of the house, and the concrete porch is complete at a lower elevation than the original as evident by the “floating”

pilasters. The November 2021 HDC meeting addressed only the two fiberglass columns and permitted their installation with a Certificate of Appropriateness.

- While the porch has undergone several changes and iterations in its configuration over time, it is staff's opinion that the relationship of the curvilinear roof of the front porch, its columns, and its clear architectural relationship to the original curvilinear steps were distinct, character-defining features of this house that have since been altered or destroyed. It is staff's opinion that the wing-walls of the current steps, especially severs this curvilinear relationship of the front elevation of this house and is inappropriate.
- It is staff's estimation that the removal of the planter boxes may have remedied a potential source of damage to the front face of the house, as soil and water against the building may have been the cause of potential damage to the brick face of the building. It is staff's opinion that these planter boxes, although historic, were not a character-defining feature that contributed to the overall historic character of the house.
- Staff requested the applicant provide the product and description of the process for removing the scarring of the front brick face of the house. As of the date of this report, staff has not received a response.
- The height of the 38" handrails exceed the 24" height of the step's wingwalls, creating a scale issue with the railing to the steps in staff's opinion.
- Staff requested a status update on the November 2021 issued COA with an open condition regarding the installation of decorative bases between the surface of the front porch and the two pilasters and two columns. The owner responded that the decorative bases will be installed in the coming weeks prior to the August 8, 2022 HDC meeting, but has not responded to a request for an update at the time of this report.

Security Lights

- Staff invited the applicant to address the installation of security lights without approval and the applicant responded with the purpose and details of the lighting equipment.
- It is staff's opinion that the side elevation locations (east and west) may be appropriate, but their current locations on the brick quoin detailing at the front elevation and the front pilasters is not appropriate. It is staff's opinion that the front pilasters, if used for lighting at all, would be of a design and style that is more appropriate for a colonial style of architecture, and distinguishes itself from security lighting that is also used on the sides of the house.



Site Photo 8, by Staff: (Northwest) front and side elevations showing locations of security lights at on the brick quoins and front pilasters of the house.

ISSUES

- All work in this application was completed without HDC approval except for the proposal to replace the fiberglass windows with aluminum clad windows, the addition of muntins to the remaining fiberglass windows and the proposed foundation planting.
- In the November 2021 HDC Regular Meeting, the Commission determined that the replacement of the original windows with fiberglass sash was issued a denial for these same fiberglass windows.
- No documentation establishing that the original wood windows were beyond repair was submitted.
- It is staff's opinion that the removal of the original wood windows has destroyed the original *scale*, *design*, and *materiality* of this historic property, and therefore does not meet the Secretary of the Interior's Standards for Rehabilitation.
- It is staff's opinion that the fiberglass windows with the applied wood muntins are not an adequate replication of the historic wood windows for the following reasons:
 - The aluminum coil stock around the brickmold is inappropriate
 - The meeting rail of the double-hung windows doesn't meet the upper and lower sash.
 - The header of the double-hung windows does not match the original dimensions of the wood windows.

- Some windows are not in their original dimensions to the double-hung windows, particularly on the west elevation.
- The tint of the glass is aqua and not clear and not appropriate.
- The installation of built-in screens, with the darker fabric tints the windows further and is inappropriate.
- The application of wood muntins on glass and fiberglass with adhesive tape is not appropriate.
- While the original window material has been removed without approval and the material is considered a character-defining feature, it is staff's opinion that the replacement of the fiberglass picture windows to restore the ribbon of double-hung windows with simulated divided light at the side and rear elevations and the replacement of fiberglass windows at the front elevation with double-hung with aluminum clad wood windows with simulated divided light and the restoration of the brick molds, is a reasonable and feasible solution in an effort to retain the dimensions, operations, and configuration of these windows, thus not greatly altering the features and spaces that characterize the property, given that the original material is lost and a true replacement may not be feasible.
- Staff identifies that both the alteration of the front porch and front steps are inappropriate as they introduce a material and design that destroys the historic character of the property (Standards 2 and 3), removed distinctive features (Standard 5), does not match the old character-defining feature of the curvilinear front porch's original steps, proportionately scaled railing, and porch roof in design, texture, and other visual properties (Standard 6), and are incompatible with the historic integrity of the property (Standard 9).
- It is staff's opinion the removal of the planter boxes as a non-contributing feature that may have been the potential source of damage to the larger house is appropriate.
- Staff has not received a response from the applicant regarding the request for the planting plan and a description of the proposed product and process for removing scarring from the front face of the house. Staff cannot assess the quality of this propose work at this time.
- Staff has the opinion that the placement of these security lights on the pilasters and brick quoin of the building alters these character-defining features and finishes of the architecture of the building by introducing a pattern of security equipment at locations that alters the exterior historic features of this building and therefore is not appropriate.

RECOMMENDATION

Section 21-2-78, Determination of Historic District Commission

Recommendation 1: Replace Wood Windows with New Fiberglass Units and Install Exterior Wood Grids; Alter Front Porch And Steps, Install Step Wingwalls And Railings And Install Security Lights

Staff finds that the replacement of original, wood windows with fiberglass windows and adhering wood grids to these replacement windows, the alteration of the front porch with the installation of wing-walled steps and the installation of security lights destroys the historic character of this property and removes distinctive, character-defining features.

Staff therefore recommends that the Commission issue a Denial for the above work items, as it does not meet the Secretary of the Interior's Standards for Rehabilitation, specifically Standards:

2. The historic character of a property shall be retained and preserved. The removal of historic materials or alteration of features and spaces that characterize a property shall be avoided.

5. Distinctive features, finishes, and construction techniques or examples of craftsmanship that characterize a property shall be preserved.

6. Deteriorated historic features shall be repaired rather than replaced. Where the severity of deterioration

requires replacement of a distinctive feature, the new feature shall match the old in design, color, texture, and other visual qualities and, where possible, materials. Replacement of missing features shall be substantiated by documentary, physical, or pictorial evidence.

9. New additions, exterior alterations or related new construction will not destroy historic materials, features and spatial relationships that characterize the property. The new work will be differentiated from the old and will be compatible with the historic materials, features, size, scale and proportion, and massing to protect the integrity of the property and its environment.

Recommendation 2: Replace Fiberglass Windows with Aluminum Clad Wood Windows, Removal of Planter Boxes, Installation of Foundation Planting

It is staff's opinion the installation of the proposed aluminum-clad windows is a reasonable and feasible solution to restore the design, operation, and configuration of the original windows, thus not greatly altering the features and spaces that characterize the property. Additionally, the removal of the planter boxes to protect the house and the proposal to treat the scarring and conceal the scarring with foundation plantings are sympathetic to the historic features of the house. Staff therefore recommends the Commission issue a Certificate of Appropriateness for the work as proposed because it meets the Secretary of the Interior Standards for Rehabilitation.

Staff recommends the Certificate of Appropriateness be issued with the following conditions:

- Applicant supply HDC staff with a planting plan that identifies the evergreen species to screen the scarring of the house where the planters once stood.
- The applicant provide HDC staff with the product and description of method to safely attempt to remove the scarring from the brick face of the house.
- HDC staff shall review and approve these submissions before their application/installation.







2011







November 16, 2021

NOTICE OF DENIAL

Mr. Mario Mongini
2011 Longfellow
Detroit, MI 48206

RE: Application Number 21-7577; 2011 Longfellow; Boston-Edison Park Historic District

Dear Mr. Mongini:

At the regular meeting that was held on November 10, 2021, the Detroit Historic District (“Commission”) reviewed the above-referenced application for building permit. Pursuant to Section 21-2-80 of the 2019 Detroit City Code, the Commission hereby issues a **Notice of Denial for the below outlined items** which is effective as of November 16, 2021. Specifically, the Commission reviewed the permit for **the below-described work**, and determined that it *does not* qualify for a Certificate of Appropriateness because it does not meet the Secretary of the Interior Standards for Rehabilitation, Standards:

- 2) The historic character of a property shall be retained and preserved. The removal of historic materials or alteration of features and spaces that characterize a property shall be avoided.*
- 5) Distinctive features, finishes, and construction techniques or examples of craftsmanship that characterize a property shall be preserved.*
- 6) Deteriorated historic features shall be repaired rather than replaced. Where the severity of deterioration requires replacement of a distinctive feature, the new feature shall match the old in design, color, texture, and other visual qualities and, where possible, materials. Replacement of missing features shall be substantiated by documentary, physical, or pictorial evidence.*

- The replacement of the original windows with fiberglass sash

Please be advised that a permit applicant that is aggrieved by a decision of the Detroit Historic District Commission concerning a permit application may file an appeal with the Michigan Department of Attorney General. Within sixty (60) days of your receipt of this notice, an appeal may be filed with:

Jon Stuckey
Michigan Department of Attorney General
2nd Floor G. Mennen Williams Building
525 West Ottawa Street
P.O. Box 30754
Lansing, MI 48909
P: 517-335-0665, F: 517-335-3088, Email: stuckeyj@michigan.gov

If you have any questions regarding the foregoing, please contact Taylor Leonard, Counsel for the Commission at (313) 237-3006.

For the Commission:



Daniel Rieden
Staff
Detroit Historic District Commission



September 16, 2022

Ms. Jennifer Ross
City of Detroit
Historic District Commission
Coleman A. Young Municipal Center
2 Woodward Avenue, Suite 808
Detroit, Michigan 48226

RE: 2011 Longfellow Avenue – Request for Rehabilitation Approval
2011 Longfellow Avenue, on the south side of Longfellow between Rosa Parks Blvd. and 14th Avenues
Violation #500

Dear Ms. Ross:

Mario Mongini, the owner of the residence at 2011 Longfellow, requests that the Historic District Commission grant approval for a replacement of forty-eight (48) original wood windows. The owner replaced these original wood windows with new fiberglass windows. The owner is seeking to mitigate damage to the historic character of the building by replacing select windows with new wood windows and adding exterior grids to the fiberglass windows proposed to remain to improve their appearance. Following approval, the Owners intend to proceed with construction work per the approved certificate of appropriateness for the exterior work.

Background

The building is a 2 1/2 story center entrance colonial structure, measuring approximately 40 feet along Longfellow avenue, by 40 feet in depth. The dominant roof is a side-facing gable roof covered in brown asphalt shingles. The center of the roof over the front door features a street-facing gable, which is flanked on either side by arch-topped dormers. The eaves feature modillions, and the house retains its original integral gutter system. Pilasters frame the center entrance. The house is clad in red brick with decorative quoins at the corners. The symmetrically placed original windows featured true divided light mullions, which were replaced with fiberglass windows, except for the remaining original windows on the third floor.

Mario Mongini, the owner of the residence, is seeking to make improvements to mitigate the fiberglass window replacement work that has occurred, and issuance of a Certificate of Appropriateness for the following work.

The building sits within the Boston-Edison Local historic district.

Scope of Work

The following describes proposed modifications to the previous application based on the Commission's comments and feedback at the November 10, 2021 Historic District Commission Meeting, Notice of

Denial, dated November 16, 2021, and comments and feedback at the August 10, 2022 Commission meeting, where the client withdrew his application prior to a vote so it could be revised.

The following is a detailed description of the scope of work regarding the work at each facade:

North (Front) Facade

Removal and replacement of eleven (11) non-approved double hung fiberglass windows with eleven (11) double hung wood windows with simulated divided lites in a pattern to match the historic windows that were removed. Four (4) windows are located at the first story, and seven (7) windows are located at the second story. Two (2) historic era double hung windows will be retained at the third story.

Removal of aluminum cladding from eleven (11) window openings and restoration of original wood brick moulds or replacement in-kind with new brick moulds to match the historic if the underlying condition is discovered to be too deteriorated to salvage.

The owner is also seeking retroactive approval for the removal of the original front porch, steps, and planter boxes that were completed by the prior owner. The current front porch, steps and wings walls that were constructed prior to his ownership of the property will be retained. Two new black metal handrails will be installed at the porch steps for safety reasons. New foundation plantings will be added to mask the brickwork that was patched in where the planter boxes were removed, and the new gas service location, which exists at the location where the east planter was located.

West (Right Side) Facade

Fourteen (14) historic era wood windows were replaced with new white fiberglass windows with grilles between the glass in a divided lites in a pattern to match the historic windows.

At the first story, six (6) windows were replaced with five (5) windows, with two (2) window openings at the sun room being combined into one (1) picture window. The picture window and the windows that flank it at each side will be removed and be replaced with four (4) wood double hung windows with simulated divided lites in a pattern to match the windows that were removed.

At the second story, six (6) windows were replaced with five (5) windows, with two (2) window openings at the sleeping porch being combined into one (1) picture window. The picture window and the windows that flank it at each side will be removed and be replaced with four (4) wood double hung windows with simulated divided lites in a pattern to match the windows that were removed.

At the third story, two (2) windows were replaced in existing openings.

In total, eight (8) wood double hung windows will be installed to match the original configuration of the windows prior to the replacement. At the six (6) fiberglass windows proposed to remain, external wood grids in a profile to mimic the muntin profile of the historic windows will be installed at the exterior surface of the glass to replicate the historic muntin pattern and provide additional depth and shadow lines. All wood trim and wood grids to be painted white to match fiberglass windows.

South (Rear) Facade

Twelve (12) historic era wood windows were replaced in existing openings with new white fiberglass windows with grilles between the glass in a divided lites in a pattern to match the historic windows. Where the existing fiberglass windows are to remain, external wood simulated divided lite grids will be installed.

At the first story, eight (8) windows were replaced with six (6) windows, with the two (2) smaller openings either side of the sunroom doors combined into one (1) picture window at each side of the door. The two (2) picture windows will be removed and replaced with four (4) wood double hung windows with simulated divided lites in a pattern to match the windows that were removed.

At the second story, four (4) windows were replaced with three (3) windows, with two (2) window openings at the sleeping porch being combined into one (1) picture window. The picture window and the windows that flank it at each side will be removed and be replaced with four (4) wood double hung windows with simulated divided lites in a pattern to match the windows that were removed.

Three (3) historic era double hung windows will be retained in the stairwell landing at the second floor.

Four (4) historic era double hung windows will be retained at the third floor.

In total, eight (8) wood double hung windows will be installed to match the original configuration of the windows prior to the replacement. At the four (4) fiberglass windows proposed to remain, external wood grids in a profile to mimic the muntin profile of the historic windows will be installed at the exterior surface of the glass to replicate the historic muntin pattern and provide additional depth and shadow lines. All wood trim and wood grids to be painted white to match fiberglass windows.

East (Left Side) Facade

Eleven (11) historic era wood windows were replaced in existing openings with new white fiberglass windows with grilles between the glass in a divided lites in a pattern to match the historic windows.

At the first story, four (4) windows were replaced in existing openings. Three (3) historic era windows will be retained.

At the second story, five (5) windows were replaced in existing openings.

At the third story, two (2) windows were replaced in existing openings.

All eleven (11) fiberglass windows are to be retained, and external wood grids in a profile to mimic the muntin profile of the historic windows will be installed at the exterior surface of the glass to replicate the historic muntin pattern and provide additional depth and shadow lines. All wood trim and wood grids to be painted white to match fiberglass windows.



Conclusion

The items listed above and attached exhibits provide a synopsis of the Owner's proposed scope of work for the rehabilitation of the residence at 2011 Longfellow Avenue. We believe that this plan effectively mitigates the outstanding violations at the property and should be approved.

Sincerely,
Infuz Architects Ltd.

A handwritten signature in black ink, appearing to read 'Allan Machielse'.

Allan Machielse, RA, NCARB
Architect

Scope of Work - 2011 Longfellow Avenue

2011 Longfellow; Boston-Edison Historic District; as follows:

- Replacement of twenty-two (22) non-approved fiberglass windows with twenty-seven (27) new wood double hung windows with simulated divided lites in a pattern to match the historic windows that were removed.
- At the eleven first and second story windows at the north elevation, remove associated aluminum wrapping and restore original brick moulds or replace in-kind as required.
- Replacement of Twenty-one (21) historic era wood windows with fiberglass double hung windows with grilles between the glass in a divided lite pattern to match the historic windows and installation of external, wood grids, in a profile to mimic the muntin profile of the historic windows at the exterior surface of the glass to replicate the historic muntin pattern and provide additional depth and shadow lines.
- Retention of existing front porch and wing walls; installation of two (2) black metal handrails at porch steps.
- Installation of new foundation plantings at either side of the front porch to mask the scars from the planters that were removed by prior owners.

From: [Mario Mongini](#)
To: [Dan Rieden](#)
Cc: [Allan Machielse](#); [Ignacio Oyuela](#); [Andrea](#)
Subject: Re: [EXTERNAL] Mongini Elevations.pdf
Date: Wednesday, October 5, 2022 2:12:07 PM
Attachments: [Railing longfellow.pdf](#)
[LUTEC Cuba longfellow final.pdf](#)

This Message Is From an External Sender

ATTENTION: This email was sent from an external source. Please be extra cautious when opening attachments or clicking links.

Mr. Rieden,

We evaluated two alternatives, one provided by Andersen and the other by Marvin. Any of these two will be chosen, based on the board decision.

Regarding the questions related to the security light, I want to make aware that we put the lights where it seemed that there were lights in the past.

Regarding the walls, that were covered by the planters removed before we purchased the house, will be cleaned with low pressure water or gentle acid-based cleaning. Nevertheless we will not address the fact that the brick used to patch this in will be different.

I am attaching the specs for the railings as well as the lights.

Best regards, Mario Mongini

From: [Allan Machielse](#)
To: [Dan Rieden](#)
Cc: [Mario Mongini](#); [Ignacio Oyuela](#); [Andrea](#)
Subject: Re: Re: [EXTERNAL] Mongini Elevations.pdf
Date: Wednesday, October 5, 2022 5:51:02 PM
Attachments: [Mongini Elevations - Rev1.pdf](#)

This Message Is From an External Sender

ATTENTION: This email was sent from an external source. Please be extra cautious when opening attachments or clicking links.

Hi Dan,

Per our conversation this afternoon, I updated the elevations and color-coded them to better explain the proposal to the commissioners. We would like the commission's approval to use either the Andersen product or the Marvin product based on final pricing, as we'd discussed on the phone. I did confirm that both of these products are aluminum-clad wood windows. They are relatively equivalent products.

Allan Machielse, RA, NCARB

Design Office Manager

O: (313) 332-1299 | M: (810) 252-4197

1111 Bellevue, Ste. 201, Detroit, MI 48207



www.virtuosodesignbuild.com

www.infuzarchitects.com

The information contained in this transmission (including any attachments) is confidential and may be privileged. It is intended only for the use of the individual or entity named above. If you are not the intended recipient, dissemination, distribution, or copy of this communication is strictly prohibited. If you have received this communication in error, please erase all copies of this message and its attachments and notify me immediately.

On Wed, Oct 5, 2022 at 2:36 PM Allan Machielse <allan@infuzarchitects.com> wrote:

Dan,

If you look in the "Comments" column of the schedule, it indicates which windows are the Marvin Infinity Fiberglass windows (which will have the external grids added), which windows will be changed out in favor of new SDL wood windows (either Marvin or Andersen based on final pricing and availability), and which windows are historic era windows to be retained. I can try to clarify this further.

Allan Machielse, RA, NCARB

Design Office Manager

O: (313) 332-1299 | M: (810) 252-4197

1111 Bellevue, Ste. 201, Detroit, MI 48207



www.virtuosodesignbuild.com

www.infuzarchitects.com

The information contained in this transmission (including any attachments) is confidential and may be privileged. It is intended only for the use of the individual or entity named above. If you are not the intended recipient, dissemination, distribution, or copy of this

From: [Mario Mongini](#)
To: [Dan Rieden](#)
Cc: [Allan Machielse](#); [Ignacio Oyuela](#); [Andrea](#)
Subject: Re: [EXTERNAL] Mongini Elevations.pdf
Date: Wednesday, October 5, 2022 2:12:07 PM
Attachments: [Railing longfellow.pdf](#)
[LUTEC Cuba longfellow final.pdf](#)

This Message Is From an External Sender

ATTENTION: This email was sent from an external source. Please be extra cautious when opening attachments or clicking links.

Mr. Rieden,

We evaluated two alternatives, one provided by Andersen and the other by Marvin. Any of these two will be chosen, based on the board decision.

Regarding the questions related to the security light, I want to make aware that we put the lights where it seemed that there were lights in the past.

Regarding the walls, that were covered by the planters removed before we purchased the house, will be cleaned with low pressure water or gentle acid-based cleaning. Nevertheless we will not address the fact that the brick used to patch this in will be different.

I am attaching the specs for the railings as well as the lights.

Best regards, Mario Mongini

Unauthorized use of this drawing set without written permission from Infuz Ltd is in violation of U.S. COPYRIGHT LAWS and will be subject to civil damages and prosecution.

Revision Schedule

#	Description	Date

SEAL

NOT FOR CONSTRUCTION

DATE SEALED

MONGINI RESIDENCE
 PROJECT NUMBER: XXXXXXXXXXXXXXXX
 2011 LONGFELLOW AVE.
 DETROIT, MI 48206
MARIO MONGINI
 SHEET TITLE
PROPOSED EXTERIOR ELEVATIONS

SHEET NUMBER

A-3.0



4 WEST ELEVATION
 1/4" = 1'-0"



3 SOUTH ELEVATION
 1/4" = 1'-0"



2 EAST ELEVATION
 1/4" = 1'-0"



1 NORTH ELEVATION
 1/4" = 1'-0"

WINDOW KEY	
BLUE	HISTORIC WINDOW TO REMAIN
RED	NEW ALUMINUM-CLAD WOOD WINDOW - MARVIN SIGNATURE ULTIMATE SERIES OR ANDERSEN E SERIES
GREEN	MARVIN INFINITY FIBERGLASS WINDOW WITH WOOD GRIDS ATTACHED TO EXTERIOR FACE OF GLAZING

NOTE: ARCHITECTURAL ELEVATIONS ARE SHOWN ONLY FOR WINDOW TYPE AND LOCATION. REFER TO WINDOW SCHEDULE FOR ADDITIONAL INFORMATION. DO NOT SCALE DRAWINGS.

Unauthorized use of this drawing set without written permission from Infuz Ltd is in violation of U.S. COPYRIGHT LAWS and will be subject to civil damages and prosecution.

Revision Schedule

#	Description	Date
---	-------------	------

SEAL

NOT FOR CONSTRUCTION

DATE SEALED

MONGINI RESIDENCE
 PROJECT NUMBER: XXXXXXXXXXXXXXXX
 2011 LONGFELLOW AVE.
 DETROIT, MI 48206
MARIO MONGINI
 SHEET TITLE
SCHEDULES

SHEET NUMBER

A-8.0

WINDOW SCHEDULE

Mark	Approximate Width	Approximate Height	Comments
1	2' - 8"	5' - 0"	NEW ALUMINUM CLAD WOOD WINDOW
2	2' - 8"	5' - 0"	NEW ALUMINUM CLAD WOOD WINDOW
3	2' - 8"	5' - 0"	NEW ALUMINUM CLAD WOOD WINDOW
4	2' - 8"	5' - 0"	NEW ALUMINUM CLAD WOOD WINDOW
5	2' - 8"	5' - 0"	NEW ALUMINUM CLAD WOOD WINDOW
6	2' - 8"	5' - 0"	NEW ALUMINUM CLAD WOOD WINDOW
7	2' - 8"	5' - 0"	NEW ALUMINUM CLAD WOOD WINDOW
8	2' - 8"	5' - 0"	NEW ALUMINUM CLAD WOOD WINDOW
9	2' - 6"	4' - 0"	NEW ALUMINUM CLAD WOOD WINDOW
10	1' - 4"	4' - 0"	NEW ALUMINUM CLAD WOOD WINDOW
11	1' - 4"	4' - 0"	NEW ALUMINUM CLAD WOOD WINDOW
12	2' - 8"	5' - 0"	HISTORIC WINDOW TO REMAIN
13	2' - 8"	5' - 0"	HISTORIC WINDOW TO REMAIN
14	2' - 8"	4' - 0"	MARVIN INFINITY FIBERGLASS WINDOW WITH APPLIED EXTERIOR MUTIN
15	2' - 8"	4' - 0"	MARVIN INFINITY FIBERGLASS WINDOW WITH APPLIED EXTERIOR MUTIN
16	2' - 8"	4' - 0"	MARVIN INFINITY FIBERGLASS WINDOW WITH APPLIED EXTERIOR MUTIN
17	2' - 8"	4' - 0"	MARVIN INFINITY FIBERGLASS WINDOW WITH APPLIED EXTERIOR MUTIN
18	2' - 8"	5' - 0"	MARVIN INFINITY FIBERGLASS WINDOW WITH APPLIED EXTERIOR MUTIN
19	2' - 8"	5' - 0"	MARVIN INFINITY FIBERGLASS WINDOW WITH APPLIED EXTERIOR MUTIN
20	1' - 6"	2' - 0"	HISTORIC WINDOW TO REMAIN
21	1' - 6"	2' - 0"	HISTORIC WINDOW TO REMAIN
22	1' - 6"	2' - 0"	HISTORIC WINDOW TO REMAIN
23	2' - 8"	3' - 4"	MARVIN INFINITY FIBERGLASS WINDOW WITH APPLIED EXTERIOR MUTIN
24	2' - 8"	5' - 0"	MARVIN INFINITY FIBERGLASS WINDOW WITH APPLIED EXTERIOR MUTIN
25	2' - 4"	5' - 0"	NEW ALUMINUM CLAD WOOD WINDOW
26	2' - 4"	5' - 0"	NEW ALUMINUM CLAD WOOD WINDOW
27	2' - 4"	5' - 0"	NEW ALUMINUM CLAD WOOD WINDOW
28	2' - 4"	5' - 0"	NEW ALUMINUM CLAD WOOD WINDOW
29	2' - 4"	5' - 0"	NEW ALUMINUM CLAD WOOD WINDOW
30	2' - 4"	5' - 0"	NEW ALUMINUM CLAD WOOD WINDOW
31	2' - 4"	5' - 0"	NEW ALUMINUM CLAD WOOD WINDOW
32	2' - 4"	5' - 0"	NEW ALUMINUM CLAD WOOD WINDOW
33	2' - 4"	5' - 0"	NEW ALUMINUM CLAD WOOD WINDOW
34	2' - 4"	5' - 0"	NEW ALUMINUM CLAD WOOD WINDOW
35	2' - 4"	5' - 0"	NEW ALUMINUM CLAD WOOD WINDOW
36	2' - 4"	5' - 0"	NEW ALUMINUM CLAD WOOD WINDOW
37	1' - 6"	5' - 0"	NEW ALUMINUM CLAD WOOD WINDOW
38	1' - 6"	5' - 0"	NEW ALUMINUM CLAD WOOD WINDOW
39	1' - 6"	5' - 0"	NEW ALUMINUM CLAD WOOD WINDOW
40	1' - 6"	5' - 0"	NEW ALUMINUM CLAD WOOD WINDOW
41	2' - 0"	5' - 0"	MARVIN INFINITY FIBERGLASS WINDOW WITH APPLIED EXTERIOR MUTIN
42	2' - 8"	5' - 0"	MARVIN INFINITY FIBERGLASS WINDOW WITH APPLIED EXTERIOR MUTIN
43	2' - 0"	5' - 0"	MARVIN INFINITY FIBERGLASS WINDOW WITH APPLIED EXTERIOR MUTIN
44	2' - 0"	3' - 0"	MARVIN INFINITY FIBERGLASS WINDOW WITH APPLIED EXTERIOR MUTIN
45	2' - 8"	6' - 6"	HISTORIC WINDOW TO REMAIN
46	1' - 6"	6' - 6"	HISTORIC WINDOW TO REMAIN
47	1' - 6"	6' - 6"	HISTORIC WINDOW TO REMAIN
48	2' - 8"	3' - 4"	MARVIN INFINITY FIBERGLASS WINDOW WITH APPLIED EXTERIOR MUTIN
49	2' - 8"	3' - 4"	MARVIN INFINITY FIBERGLASS WINDOW WITH APPLIED EXTERIOR MUTIN
50	2' - 8"	3' - 4"	MARVIN INFINITY FIBERGLASS WINDOW WITH APPLIED EXTERIOR MUTIN
51	2' - 8"	3' - 4"	MARVIN INFINITY FIBERGLASS WINDOW WITH APPLIED EXTERIOR MUTIN
52	2' - 8"	3' - 4"	MARVIN INFINITY FIBERGLASS WINDOW WITH APPLIED EXTERIOR MUTIN
53	2' - 8"	3' - 4"	MARVIN INFINITY FIBERGLASS WINDOW WITH APPLIED EXTERIOR MUTIN
54	2' - 8"	3' - 4"	MARVIN INFINITY FIBERGLASS WINDOW WITH APPLIED EXTERIOR MUTIN
55	2' - 8"	5' - 0"	MARVIN INFINITY FIBERGLASS WINDOW WITH APPLIED EXTERIOR MUTIN
56	2' - 8"	5' - 0"	MARVIN INFINITY FIBERGLASS WINDOW WITH APPLIED EXTERIOR MUTIN
57	2' - 8"	4' - 0"	HISTORIC WINDOW TO REMAIN
58	2' - 8"	4' - 0"	HISTORIC WINDOW TO REMAIN
59	2' - 8"	4' - 0"	HISTORIC WINDOW TO REMAIN
60	2' - 8"	4' - 0"	HISTORIC WINDOW TO REMAIN

J. Kaltz & Co.

730 East Nine Mile Rd.
Ferndale, MI 48220
1-800-466-8800
Fax: 248-541-5231

3987 Brockton Dr., SE • Ste. C
Kentwood, MI 49512
1-800-466-6070
Fax: 616-942-7627

www.jkaltzco.com

PORCH AS OF AUG. 2015

2011 LONGFELLOW
05 AUG. '22

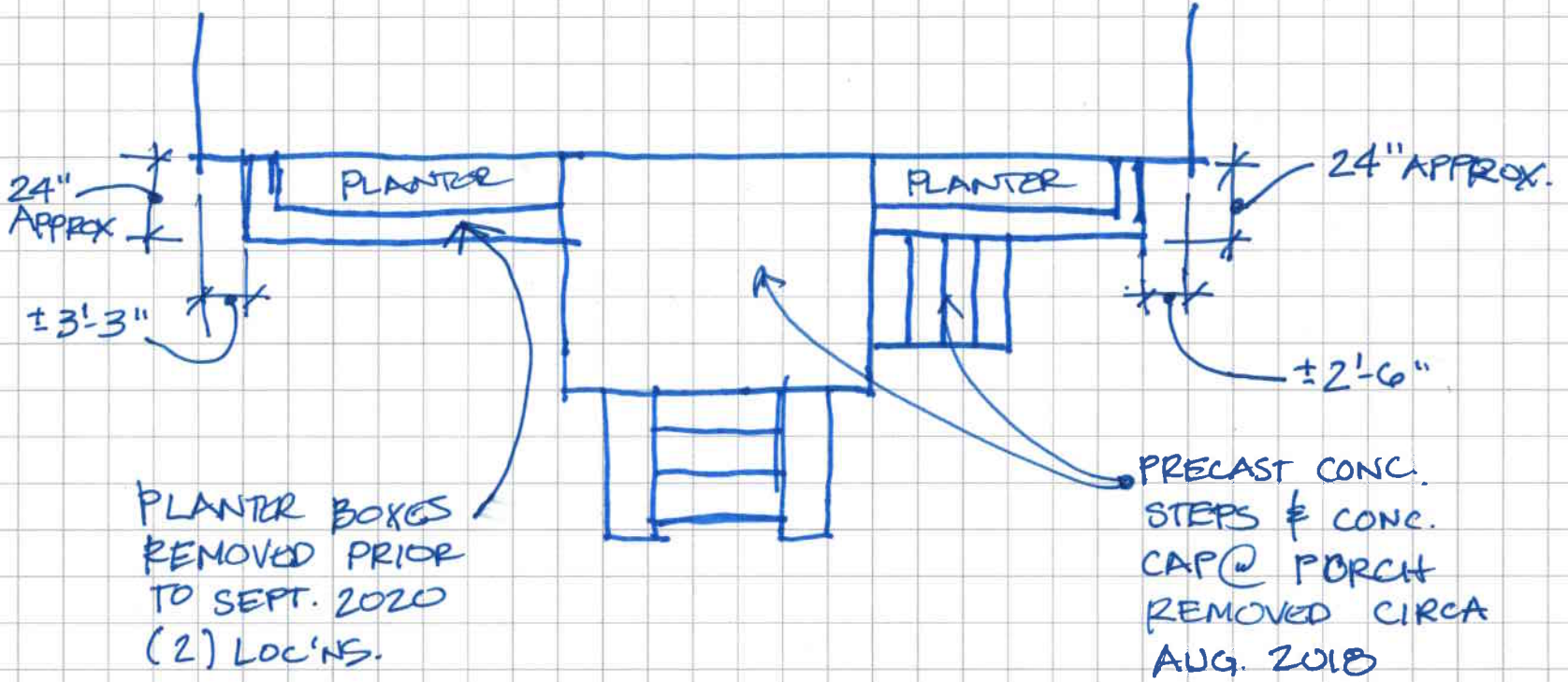

J. Kaltz & Co.

730 East Nine Mile Rd.
Ferndale, MI 48220
1-800-466-8800
Fax: 248-541-5231

3987 Brockton Dr., SE • Ste. C
Kentwood, MI 49512
1-800-466-6070
Fax: 616-942-7627

www.jkaltzco.com

SUB

EXISTING CONDITIONS

2011 LONGFELLOW
05 AUG. '22

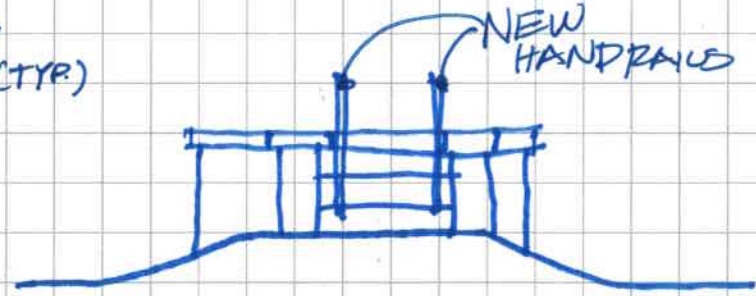
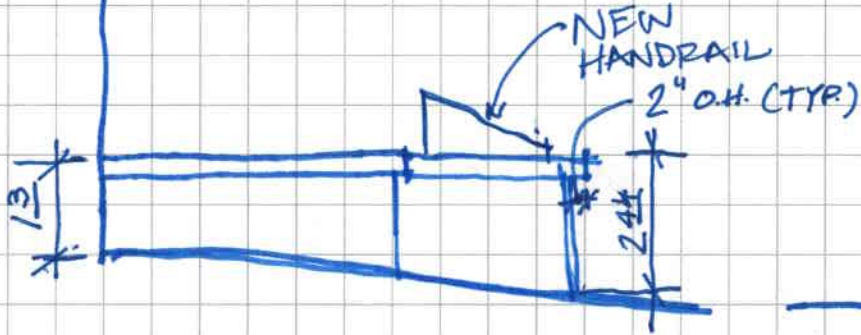
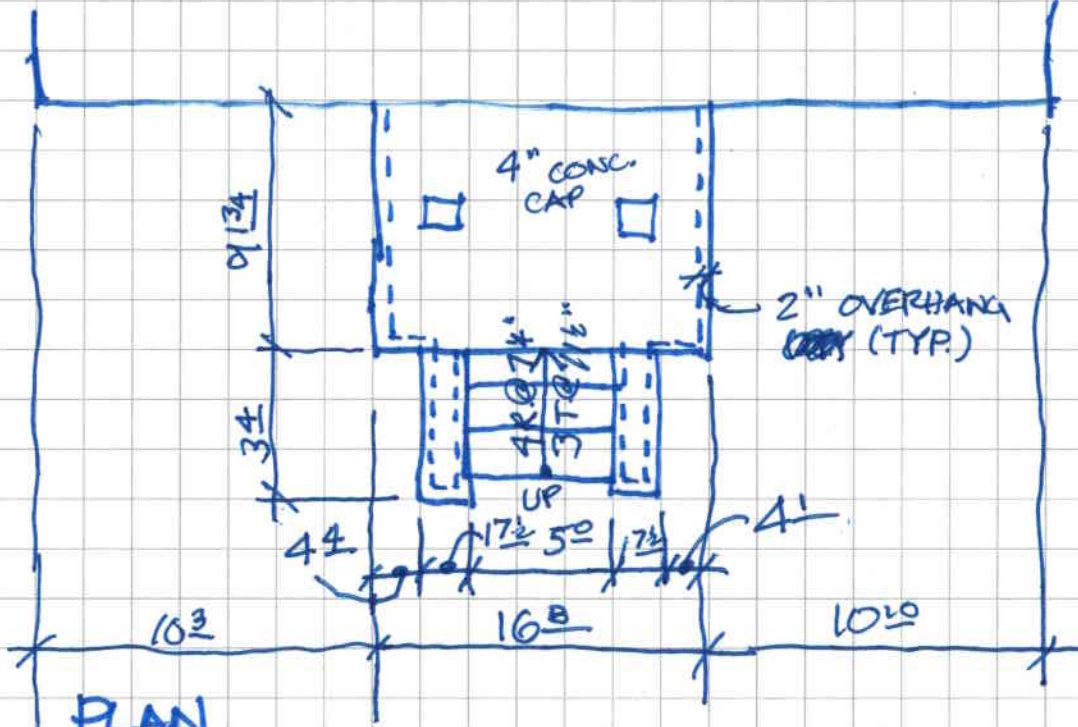

PRE-WINDOW REPLACEMENT PHOTOS



FRONT (SOUTH) ELEVATION



SIDE (WEST) ELEVATION



SIDE (WEST) ELEVATION



SIDE (WEST) ELEVATION



REAR (SOUTH) ELEVATION



SIDE (EAST) ELEVATION

POST-WINDOW REPLACEMENT PHOTOS



FRONT (SOUTH) ELEVATION



SIDE (WEST) ELEVATION



SIDE (WEST) ELEVATION



REAR (SOUTH) ELEVATION



SIDE (EAST) ELEVATION

FRONT PORCH SCOPE OF WORK



PORCH - FRONT (NORTH) ELEVATION



PORCH - SIDE (EAST) ELEVATION



PORCH - SIDE (EAST) ELEVATION



PROPOSED NEW RAILING



PLANTER LOCATION - WEST SIDE



PLANTER LOCATION - EAST SIDE W/ NEW GAS SERVICE LOCATION



Tools & Home Improvement > Building Supplies > Building Materials > Decking & Fencing > Railings & Pickets > Railings

Purchased 2 times.
Last purchased Jul 24, 2022
Size: 2FT | Color: Black | [View order](#)



Share

Happybuy Handrails for Outdoor Steps, Fit 2 or 3 Steps Outdoor Stair Railing, Picket#2 Wrought Iron Handrail, Flexible Porch Railing, Black Transitional Handrails for Concrete Steps or Wooden Stairs

[Visit the Happybuy Store](#)
616 ratings
87 answered questions

List Price: ~~\$132.02~~
Price: **\$120.92**
FREE Returns
You Save: **\$11.10 (8%)**

Buy more, save more:
2 units **\$115.92** Save 12%
5 units **\$111.92** Save 15% **LOWEST PRICE**

Earn 5% Back on this purchase when you pay with your **Amazon Business Prime American Express Card**.

Eligible Prime membership required. Terms and cap apply.
May be available at a lower price from **other sellers**, potentially without free Prime shipping.

Size: **2FT**
1FT **2FT** 3 Feet 4FT

Color: **Black**

Brand Happybuy
Material Iron
Color Black
Item 52 x 35 x 3 inches
Dimensions LxWxH
Finish Type Powder Coated

About this item

\$120.92

FREE Returns

FREE delivery **Friday, October 7.**
Order within **10 hrs**

Deliver to Huapi - Grosse Point...
48236

In Stock.

Quantity: **1**

Buying in bulk?

Add to Cart

Secure transaction

Sold by Amazon and Fulfilled by Amazon.

Return policy: **Eligible for Return, Refund or Replacement within 30 days of receipt**

Shows what's inside. Item often ships in manufacturer container to reduce packaging. If this is a gift, consider shipping to a different address.

Add a Protection Plan:
 3-Year Protection for **\$25.40**
 Add a gift receipt for easy returns

Add to List

New & Open Box (3) from **\$116.08**

Other Sellers on Amazon
\$159.99 **Add to Cart**
& **FREE Shipping**
Sold by: LOVSHARE

Have one to sell?

Sell on Amazon

- **[FOR 2 OR 3 STEPS]** - One Picket#2 Handrail for 2 or 3 steps. Intended to Span 2 Stair Risers – Measures 2 foot Post to Post (Unadjustable).
- **[REAL WROUGHT IRON]** - This handrail is constructed with real wrought iron that is durable and rustproof.
- **[EASILY SET UP & CLEAN]** - This kit includes everything you will need to attach the handrail to your concrete steps. Also, easy to clean for its powder coating surface.
- **[STEADY & DELICATE DESIGN]** - Designed with powder coating technology, it is constructed with stylish matte black. The handrail is strongly connected and welded.
- **[WIDE APPLICATION]** - Widely used for gardens, residential buildings, commercial office buildings, hotels, etc.

› See more product details



Serving low prices with virtual cooking lessons
Amazon Explore [Browse now](#)

How to Refinish Deck Railings

Items Recommended by This Old House



This Old House

Earns commissions

Duration: 2+ hours

Difficulty: Easy to moderate

[View full article](#)



FROGTAPE 240661 Multi-Surface Painter's Tape wi...

15,609

\$25.34



AmazonCommercial Plastic sheeting - 10x25ft - 6 Mi...

1,950

\$21.99



All Purpose Canvas Drop Cloth by CCS CHICAGO C...

9,656

\$17.95

4 stars and above

Page 1 of 26

Sponsored ⓘ



CHR 5 Steps Outdoor Hand Rails for Steps, Black Wrought Iron Handrail Kit (4-5 Step...

579

#1 Best Seller
\$127.23

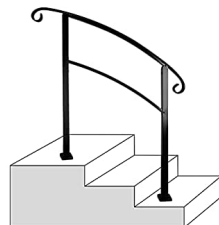

Cocopark High Quality 3-Step Adjustable Wrought Iron Handrail Railing Stair Rail fo...

98

\$128.00
Save 5% with coupon



Metty Metal Outdoor Stair Railing, White Handrails for Outdoor Steps 2 Step Handrail...

252

\$98.89

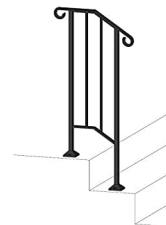

Iron X Handrail Picket #1 (Concrete Steps)

118

\$348.00

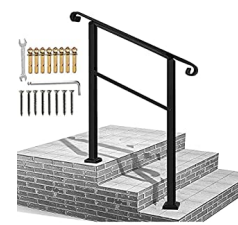

Handrails for Outdoor Steps, 3 Step Handrail Fits 1 to 3 Steps Mattle Wrought Iron H...





550

\$99.99
\$94.99 with quantity discounts

Customers frequently viewed

Page 1 of 20

Sponsored ⓘ | Popular products in the last 7 days

 <p>CHR 5 Steps Outdoor Hand Rails for Steps, Black Wrought Iron Handrail Kit (4-5 Step...</p> <p>579</p> <p>#1 Best Seller</p> <p>\$127.23</p>	 <p>Happybuy 3-Step Transitional Handrail Fits 1 or 3 Steps Matte Stair Rail Wrought Ir...</p> <p>38</p> <p>Amazon's Choice</p> <p>Decking Railings</p> <p>\$69.99</p>	 <p>Metty Metal Outdoor Stair Railing, White Handrails for Outdoor Steps 2 Step Handrail...</p> <p>252</p> <p>\$98.89</p>	 <p>Handrails for Outdoor Steps 3Ft Stair Handrail, Outdoor Stair Railing Fits 1 to 3...</p> <p>501</p> <p>\$93.07</p>	 <p>Cocopark High Quality 3-Step Adjustable Wrought Iron Handrail Railing Stair Rail fo...</p> <p>98</p> <p>\$128.00</p> <p>Save 5% with coupon</p>
--	---	--	--	--

Special offers and product promotions

- [Amazon Business](#): Save time and money with your Amazon Business account. [Sign in now to see business-only prices.](#)

Product Description

VEVOR®

TOUGH EQUIPMENT & TOOLS, PAY LESS



VEVOR®

WROUGHT IRON HANDRAIL

Fit for 2 or 3 Steps
Real Iron Material



VEVOR®

Features:



Fit 2 to 3 Steps

As a great helper for your family members to go up and down the stairs, this wrought iron handrail fits 2 or 3 steps. It spans max 3 stair risers and measures 28"/71 cm post to post.

Features:



Flexible Height

With screws connection, this outdoor stair railing is height changeable to suit steps of different sizes. The max height for stairs is 14.6"/37 cm, flexible to meet your various needs.



Real Wrought Iron

Our front porch hand rail is constructed with real wrought iron, ensuring it is rustproof and corrosion-proof. As a result, the handrail keeps a long lifespan under various weather conditions.

EASY TO ASSEMBLE

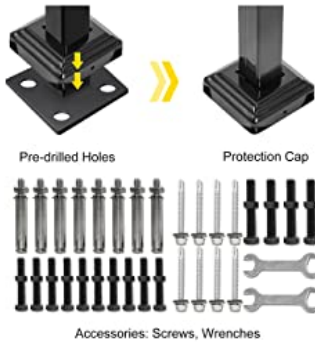

Easy to Assemble

The handrails for concrete steps kit includes everything you need to attach the rails and posts to the stairs. It is simple to install and complete.

ELEGANT & FASHION STYLE



Elegant & Fashion Style

Designed with a powder coating surface, the railings for steps are easy to maintain and clean. The stylish and elegant appearance provides

VERSATILE USES

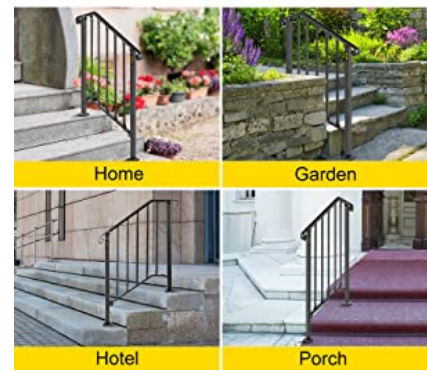

Versatile Uses

The outdoor railing for steps is suitable for home, garden, hotel, porch, and other places with stairs or steps. It serves as a support to improve security

Suggested Height:
11.8 in / 30 cm
Max Height:
14.6 in / 37 cm

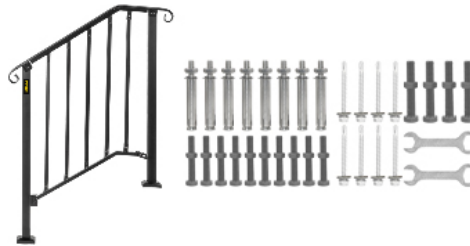
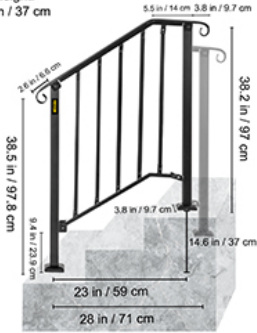

Package Content

- 1 x Handrail
- 10 x M6 Bolts
- 4 x M8 Bolts



4 or 5 Steps



3 or 4 Steps



2 or 3 Steps



2 or 3 Steps



1 or 2 Steps



3 Steps

Material:	Real Iron Metal	Real Iron Metal	Real Iron Metal	Real Iron Metal	Real Iron Metal	Stainless Steel
Size:	4 or 5 Steps	3 or 4 Steps	2 or 3 Steps	2 or 3 Steps	1 or 2 Steps	3 Steps
Color:	Black	Black	Black	Black	Black	Black
	✓	✓	✓	✓	✓	✓
	✓	✓	✓	✓	✓	✓
	✓	✓	✓	✓	✓	✓
	✓	✓	✓	✓	✓	✓
	✓	✓	✓	✓	✓	✓

Compare with similar items



This item:
Happybuy Handrails for Outdoor Steps, Fit 2 or 3 Steps Outdoor Stair Railing, Picket#2 Wrought Iron Handrail, Flexible Porch Railing, Black Transitional Handrails for Concrete Steps or Wooden Stairs

\$120⁹²

(616)

Add to Cart



SPACEUP Step Handrail Fit for 2 or 3 Steps Wrought Iron Handrail for Outdoor Steps Matte Black Stair Railings with Installation Kit

\$179⁹⁹

(55)

Add to Cart



VEVOR Handrails for Outdoor Steps, Fit 3 or 4 Steps Outdoor Stair Railing, Picket#3 Wrought Iron Handrail, Flexible Porch Railing, White Transitional Handrails for Concrete Steps or Wooden Stairs

\$163¹³

(40)

Add to Cart



CHR Outdoor 3 Steps Handrail - Black Wrought Iron Handrail Kit (2-3 Step, Handrail)

#1 Best Seller

\$99⁹⁷

(580)

Add to Cart



VEVOR Outdoor Stair Railing, Fits for 1-5 Steps Transitional Wrought Iron Handrail, Adjustable Exterior Stair Railing with Fence, Handrails for Concrete Steps with Installation Kit, Matte Black

\$149⁹⁸

(26)

Add to Cart



VEVOR Outdoor Stair Railing, Fit 1 or 2 Steps Alloy Metal Handrail, Front Porch Flexible Transitional Handrail, Picket Step Rail with Installation Kit, for Concrete or Wooden Stairs, Black

\$89⁹⁹

(14)

Add to Cart

Compare differences

Options

Sold By	Amazon	SPACEUP	Amazon.com	CR Handrail	tuorren	Amazon
Quantity discounts Exclusive discounts offered to business customers who buy multiple units.	See all discounts	—	—	—	—	See all discounts
Color	Black	2-3 Step Railing	White	Handrail	Black	Black
Material	Iron	Wrought Iron	Iron	Metal	Wrought Iron	Stainless Steel, Wood
Size	2FT	2Ft	3 or 4 Steps	3 Steps	—	—

Product information

Technical Details

Additional Information

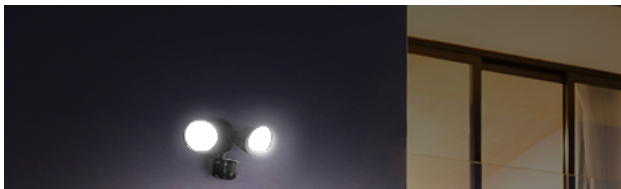

LUTEC

Light Your Way Home

Founded in 1972

Product Description

LIGHT YOUR WAY HOME

- 40+ years of history
- 800+ products patents worldwide
- 150+ countries covered
- 30+ brand agents worldwide
- 9 times design awards
- 9 design teams worldwide
- 5 factories worldwide
- 4 central warehouse worldwide

European Brand





German Designer Director
Mr. Jeremy Morgan

WON AWARD FOR
IF Design Award and Reddot

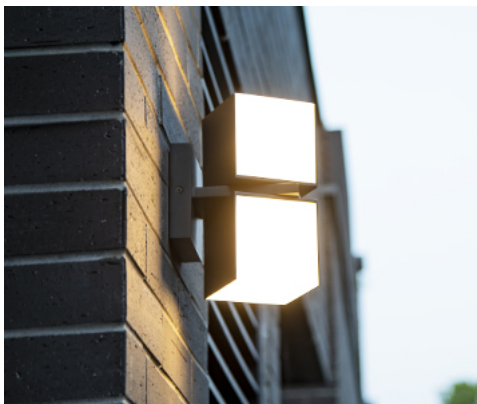

reddot award 2021
winner





LUTEC

REDDOT AWARD WINNER

BRINGS YOU THE PEACE AND DELIGHT OF NIGHTTIME

LED rubik's cube wall lamp
Two moveable heads
Energy efficiency&long lasting

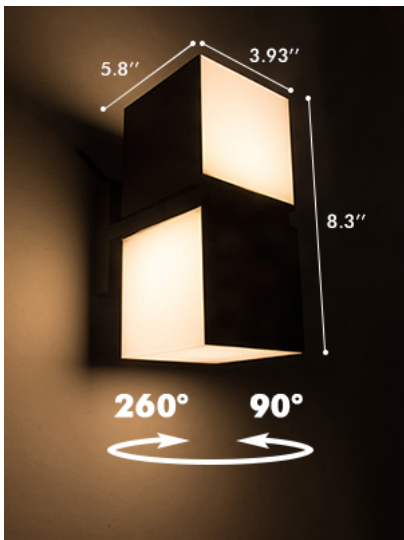

LUTEC

About LUTEC

LUTEC is a brand of the company Ningbo Utec, established in 1972. LUTEC is one of China's leading vertical integrated manufacturers of premium outdoor lighting and one of the world's leading producers of high quality affordable lighting. The name LUTEC is a quick and simplified way to say: "we at LUTEC, know how to design Lighting that is relevant for U and embrace our TECHNICAL background." The LUTEC brand provides the basis for a strong international network in outdoor lighting.

MEIUM EXTERIOR COASTAL WITH CLEAR PC



ROTATABLE HEADS

The 2 light heads can be rotated over 350°, resulting in up-down or side light effects.



4 GLOWING SURFACES

The wall light has 4 glowing surfaces which can provide multi-directional lighting to accentuate your indoor and outdoor places.



INTERGRATED LED WALL LIGHT

Led integrated, You no longer need to change bulbs! We promise 5 years service for your rights and interests.

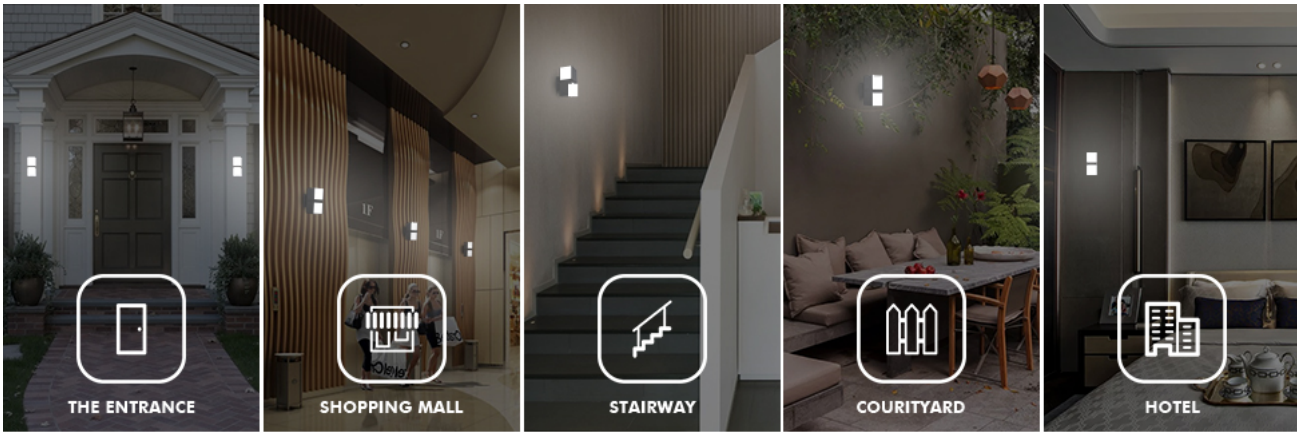

Product information

Technical Details

Brand	LUTEC
Color	Black
Material	Aluminum, Polycarbonate
Style	Modern
Light fixture form	Sconce
Room Type	Bedroom
Indoor/Outdoor Usage	Outdoor, Indoor
Power Source	Corded-electric
Product Dimensions	5.8"L x 3.93"W x 8.3"H
Light Source Type	LED
Shade Material	Aluminum
Shape	Square
Included Components	LED Lens
Light Direction	Adjustable
Item Package Quantity	1
Wattage	23 watts
Manufacturer	LUTEC
Part Number	1
Item Weight	3.54 pounds
Package Dimensions	9.21 x 6.22 x 4.61 inches
Country of Origin	China
Item model number	amzn.gr.5193805012-6PFYrD7ODnwHwkLJHN-LN
Switch Installation Type	Surfaces,Wall Mount
Batteries Required?	No
Luminous Flux	1100 Lumen
Color Temperature	3000 Kelvin

Additional Information

ASIN	B08R8KKZVK
UNSPSC Code	39110000
Customer Reviews	1,288 ratings 4.6 out of 5 stars
Best Sellers Rank	#17,079 in Patio, Lawn & Garden (See Top 100 in Patio, Lawn & Garden) #79 in Wall Sconces #143 in Patio Wall Light Fixture #2,199 in Outdoor Décorative Lighting
Date First Available	December 24, 2020

Warranty & Support







Product Warranty: For warranty information about this product, please [click here](#)

Feedback

Would you like to [tell us about a lower price?](#)

Related products with free delivery

Sponsored ⓘ

 <p>LED Wall Pack Light 25W, 3000Lm 5000K Daylight (Dusk to Dawn Photocell Included) ET...</p> <p>128</p> <p>\$24.99</p>	 <p>LMP 4 Pack LED Square Up and Down Lights Outdoor Wall Light, Body in Aluminum Waterp...</p> <p>3,115</p> <p>\$118.40 (\$29.60/Count)</p>	 <p>LED Outdoor Wall Light, 3 Color Changing Outdoor Wall Sconce, Waterproof 8W Porch L...</p> <p>18</p> <p>\$53.50</p>	 <p>DAKAFUL LED Up and Down Lights Outdoor Wall Sconce, 2Pack Integrated Square outdoor...</p> <p>109</p> <p>\$56.99 (\$28.50/Count)</p>	 <p>LUTEC 1000 Lumen 3000K 45 LED Wall Light Dusk to Dawn, Modern Porch Light with Seed...</p> <p>1,157</p> <p>\$68.87</p>	 <p>LMP Du Outdoor Down \ Porch L</p> <p>\$89.9</p>
--	--	---	---	--	---

Window Replacement Guide

INFINITY[®]

from MARVIN[®]

REPLACEMENT WINDOWS

Built for life[®]

Get expert guidance

Depending on the age and style of your home, Infinity offers two window replacement methods. Your local Infinity partner will help you determine the best solution for your home, including addressing any concerns about water or structural damage. Both methods are designed for maximum efficiency and minimal disruption to your home.

Insert replacement

With insert window replacement, new windows are easily installed into the existing frame. This is generally a quicker replacement solution because the existing trim and siding are not replaced.

Full-frame replacement

Full-frame replacement requires taking out the existing damaged frame and trim. This window installation method offers the possibility of replacing your existing window with an entirely new style or larger window.



DOUBLE AND SINGLE HUNG



SLIDER



CASEMENT



AWNING

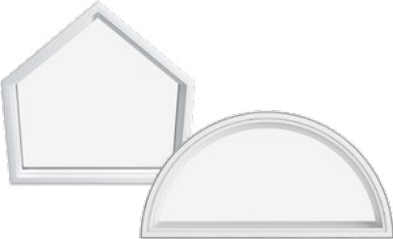

SPECIALTY SHAPES AND ROUND TOPS



BAY



BOW

Infinity Double Hung

Unit Features

Infinity Double Hung: NDH

Infinity Double Hung Transom: NDHTR

Infinity Double Hung Picture: NDHP

Ultrex® Pultruded Fiberglass Frame:

- Frame thickness: 31/32" (25) head jamb, 31/32" (25), side jamb, 25/32" (20) sill, flat bottom sill with 8 degree bevel
- Frame depth: 2 7/8" (73)
- Exterior colors: Stone White, Sierra, Cashmere, Pebble Gray, Bahama Brown, Bronze, Ebony
- Interior colors: Stone White, Sierra, Ebony, Bronze, EverWood™

Ultrex® Pultruded Fiberglass Sash:

- Sash thickness: 1 3/8" (35)
- Different sash option allows unequal sash heights, unique lite cuts for each sash or different glazing in each sash
- Operable sash tilts to interior for cleaning or removal
- Sash are replaceable but cannot be re-glazed
- Exterior colors: Stone White, Sierra, Cashmere, Pebble Gray, Bahama Brown, Bronze, Ebony
- Interior colors: Stone White, Sierra, Ebony, Bronze, EverWood™

Hardware:

- Lock and keeper:
 - Mounted at the center of the top check rail or 12" (305) on center from either end on dual lock unit
 - Zinc die-cast
- Sash lift:
 - Factory drilled for a bottom sash lift
 - Single lock units receive single lift; dual locks unit receive double lifts
 - Zinc die-cast
- Balance system:
 - Coil spring block and tackle with nylon cord and fiber filled nylon clutch
 - Allows the sash to raise or lower from desired position
- Bottom sash tilt latches:
 - Spring loaded tilt latches attached to upper corners of sash and operated with a button on the lock for easy tilting and sash removal
 - Tilt latches are mounted to the window stile and hidden under the check rail cover for a clean look
- Top sash tilt latches:
 - Spring loaded tilt latches attached to upper corners of sash
 - Injection molded nylon - white, black or beige
 - Hidden from view in the frame header when window is closed
- Top sash hanger (fixed upper sash only):
 - Attached to the frame securing the top sash making it stationary
 - Metal stamped
 - Color: white or black
- Optional factory applied Window Opening Control Device
 - Available on all operable units
 - Color: white, black or beige
 - This device works in accordance to ASMT F2090-17 Standard Specification for Window Fall Prevention Devices with Emergency Escape (Egress) Release Mechanisms.

Weather Strip:

- Frame:
 - Jamb: foam filled bulb with flexible TPE skin
 - Color: white, black or beige
 - Parting stop: PVC with flexible hinged wand seal
 - Color: white, black or beige
- Sash:
 - Bottom sash: white, black or beige hollow foam bulb type
 - Check rail: white, black or beige, PVC with flexible hinged wand seal
- Stationary units:
 - Continuous, foam weather strip at perimeter of sash
 - Color: White, Black or Beige

Unit Features

Insect Screens:

- Full screen
- Optional half screen
- Extruded aluminum frame: 0.050" wall thickness
- Standard screen mesh material: charcoal fiberglass
- Optional screen mesh material: high transparency screen
- Corners are mitered and joined with an internal corner key, which are not visible
- Friction fit pins are integrated into the side of the screen
- Frame color: matches exterior frame color

Glass:

- Glazing seal: silicone bedding on interior and exterior
- Standard glass is insulating Low E2 with Argon or air
- Optional glazing available: Low E1 with Argon or air, Low E3 with Argon or air, or Low E3/ERS with Argon or air, tempered, obscure
- Decorative glass options include Glue Chip, Rain, Reed, Narrow Reed, or Frost
- Decorative glass is not available with Low E1, Low E3/ERS, or STC/OITC
- Rain, Reed and Narrow Reed not available with SDL
- SDL available on Frost, annealed or tempered glass
- SDL available on Glue Chip, tempered glass required
- Insulating glass will be altitude adjusted with capillary tubes for higher elevations
- Argon gas is not available for elevations that require capillary tubes

Simulated Divided Lites (SDL):

- 7/8" (22) or 1 1/8" (29) SDL bar (interior and exterior)
- 2 11/32" (30) simulated rail only (interior and exterior)
- Exterior color: matched to unit exterior
- Interior color: matched to interior
- Pattern: equal rectangular, cottage, prairie, check rail and oriel

Gilles-Between-the-Glass (GBG):

- 23/32" (18) or 1" (25) contoured aluminum bar
- Exterior: Customer selection option available. All exterior color options.
- The exterior GBG color is designed to best match the unit exterior color when used with Low E glass. The use of different types of glazing options may alter the exterior GBG color appearance
- Interior color: White, Satin Taupe, Sierra, Bronze and Ebony
- Pattern: equal rectangular, cottage, prairie, check rail and oriel
- GBG's are not available with dual 4.7mm glass panes. Refer to OMS for availability.

NOTE: GBG may not be available or may require tempered glass if the glass size is greater than 16 square feet or if the short side dimension is greater than 48". Please contact your local Infinity Retailer or Infinity Support at 800-372-1072 to determine if GBG is available for glass sizes exceeding these dimensions.

Infinity Double Hung

Lite Options

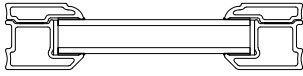

Insulating Glass

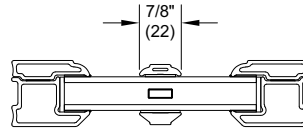

Insulating Glass
7/8" SDL w/ spacer bar

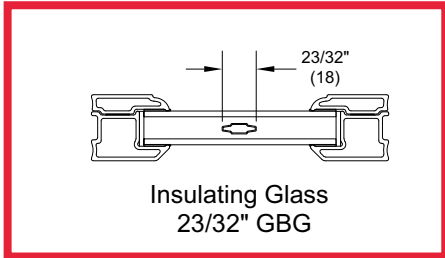

Insulating Glass
23/32" GBG

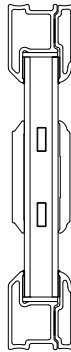

Insulating Glass
SDL Simulated Rail
w/spacer bar

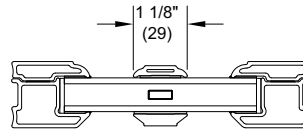

Insulating Glass
1 1/8" SDL w/ spacer bar

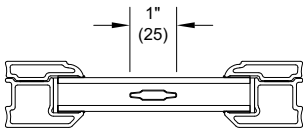

Insulating Glass
1" GBG

Minimum and Maximum Guidelines

Minimum and Maximum Frame Size Guidelines - Standard Size												
Unit Type		Minimum Frame Size				Maximum Frame Size				Maximum Glass		
		Width		Height		Width		Height				
		in	mm	in	mm	in	mm	in	mm	Sash Size	Sq. Feet	Sq. Meters
NDH	Equal Sash	14 3/8	(365)	25 5/8	(651)	48	(1219)	96	(2438)	regular	13 45/64	1.27
NDH	Cottage Style	14 3/8	(365)	30 1/8	(765)	48	(1219)	72	(1829)	small	8 3/64	0.75
										large	13 27/64	1.25
NDH	Oriel Style	14 3/8	(365)	30 1/8	(765)	48	(1219)	96	(2438)	small	10 31/32	1.02
										large	18 9/32	1.70
NDHP NDHTR	Picture Transom	18	(457)	16 3/8	(416)	75	(1905)	75	(1905)	regular	30	2.79

Minimum and Maximum Frame Size Guidelines - Expanded Size												
Unit Type		Minimum Frame Size				Maximum Frame Size				Maximum Glass		
		Width		Height		Width		Height				
		in	mm	in	mm	in	mm	in	mm	Sash Size	Sq. Feet	Sq. Meters
NDH	Equal Sash	48 1/32	(1220)	25 5/8	(651)	54	(1372)	85	(2159)	regular	13 11/16	1.27
NDH	Cottage Style	48 1/32	(1220)	30 1/8	(765)	54	(1372)	60	(1524)	small	7 1/2	0.70
										large	12 1/2	1.16
NDH	Oriel Style	48 1/32	(1220)	30 1/8	(765)	54	(1372)	85	(2159)	small	10 15/16	1.02
										large	18 1/4	1.70

NOTE: Fixed upper sash required on certain sizes. Contact Infinity Support for more information.

For Glue Chip and Frost, maximum short frame side is 63 1/4".

For Rain, Reed and Narrow Reed, vertical pattern orientation maximum frame width size 63 1/4".

For Reed and Narrow Reed, horizontal pattern orientation maximum sash height 61 1/8" for operating unit, 63 1/4" for transom and picture units.

Tempered glass may be required if the glass size is greater than 23 square feet. Please contact your local Infinity Retailer or Infinity Support at 800-372-1072 to determine available glass options on units exceeding this size.

Infinity Double Hung

Certified Sizes and Ratings

Product	Air Tested to psf	Water Tested to psf	Design Pressure (DP)	Certification Rating	Max Overall Width		Max Overall Height	
					in	mm	in	mm
Infinity Double Hung	1.57	3.76	25	LC-PG25-H	54	(1372)	85	(2159)
Infinity Double Hung	1.57	4.6	30	LC-PG30-H	48	(1219)	96	(2438)
Infinity Double Hung Picture	1.57	4.5	30	LC-PG30-FW	72	(1829)	72	(1829)
	1.57	4.5	30	LC-PG30-FW	60	(1524)	75	(1905)
	1.57	4.5	25	LC-PG25-FW	75	(1905)	75	(1905)

Infinity Double Hung

STC/OITC Glass Values

STC/OITC ratings are shown in the chart below. Infinity's STC/OITC values are provided by third party ASTM testing and reports. The STC/OITC Upgrade option incorporates variable glass thickness or laminate (L) to increase STC/OITC performance and improve sound abatement.

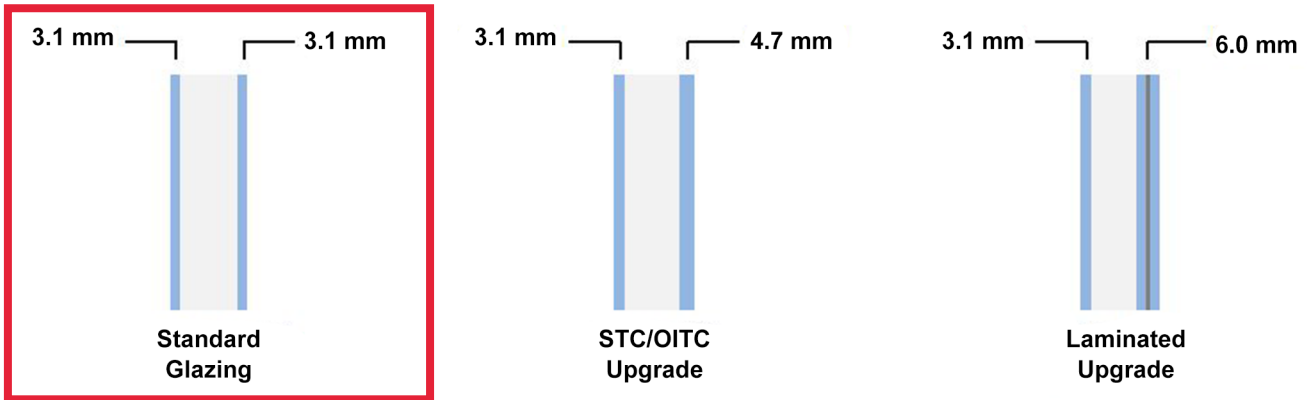

Product Type	Exterior Glazing	Airspace	Interior Glazing	STC	OITC
Full Frame Double Hung	1/8" (3.1)	15/32" (11.5)	1/8" (3.1)	26	22
	1/8" (3.1)	3/8" (9.8)	3/16" (4.7)	30	26
	1/8" (3.1)	5/16" (8.0)	1/4" (6.0L)	32	27
Full Frame Double Hung Picture	1/8" (3.1)	15/32" (11.5)	1/8" (3.1)	28	25
	1/8" (3.1)	3/8" (9.8)	3/16" (4.7)	31	27
	1/8" (3.1)	5/16" (8.0)	1/4" (6.0L)	33	28

Infinity Double Hung

Section Details: Operator

Scale: 3" = 1' 0"

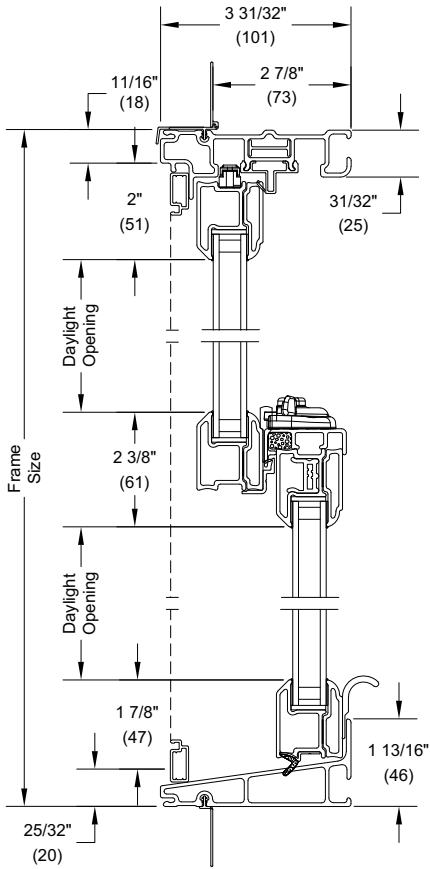

**Head Jamb and Sill
NDH w/ Full Screen**

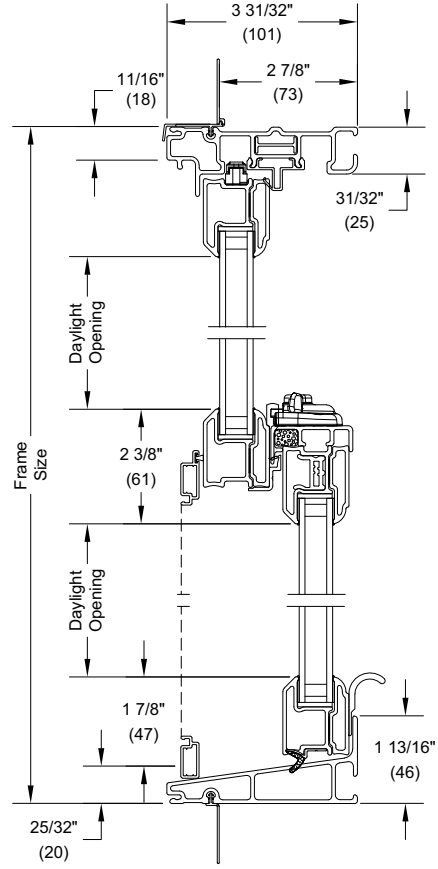

**Head Jamb and Sill
NDH w/ Half Screen**

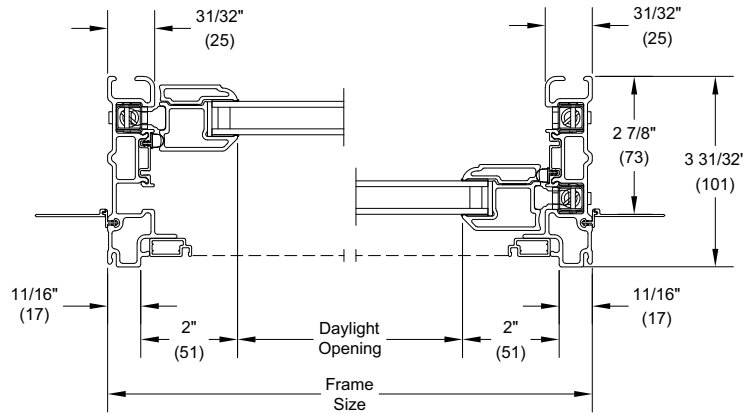

Jamb

Infinity Double Hung

Section Details: Picture/Transom

Scale: 3" = 1' 0"

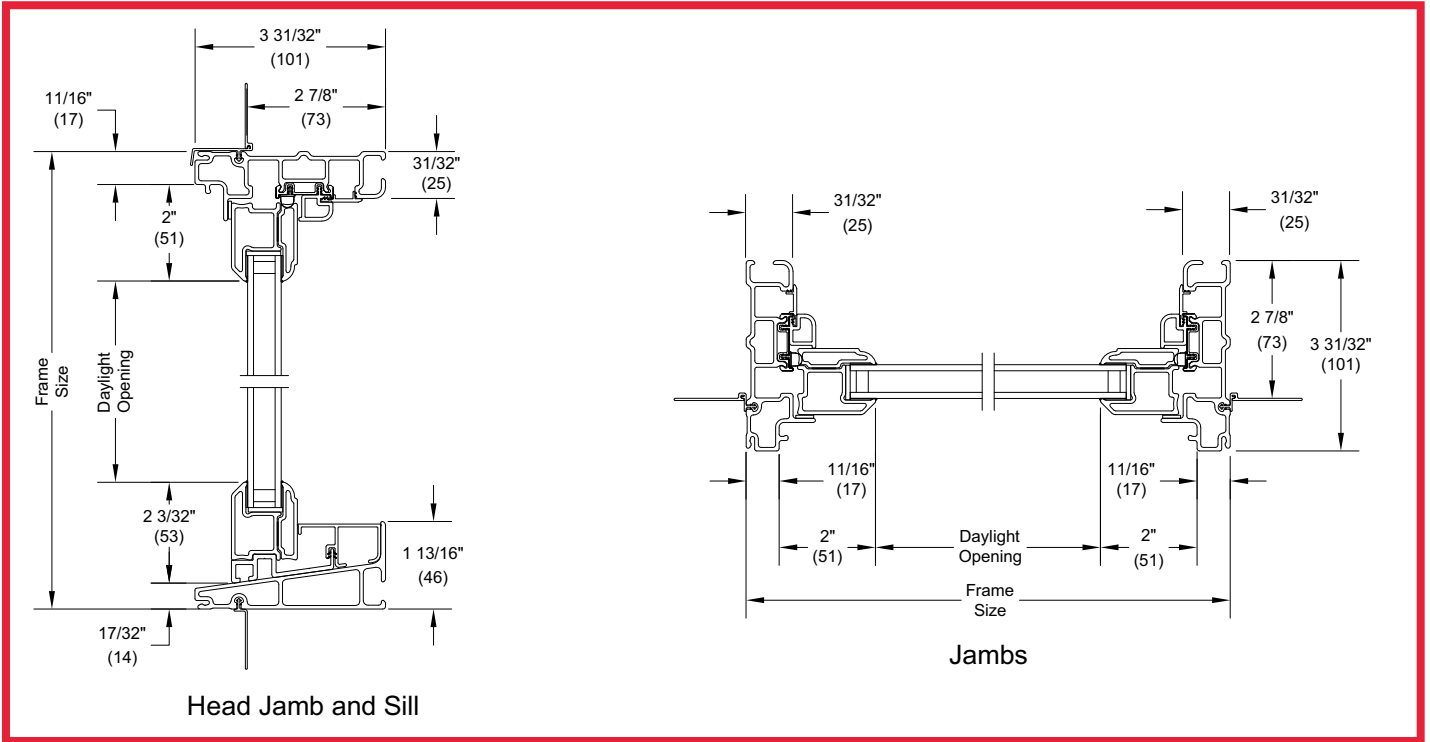



Wood Grille Profiles

Please contact us toll free at
855-318-5022 or
orders@bigbluewindow.com
for additional help.

7/8" Profiles

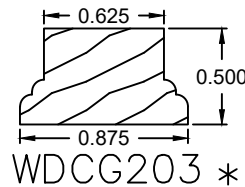
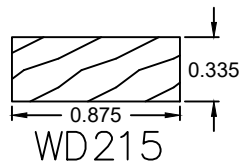
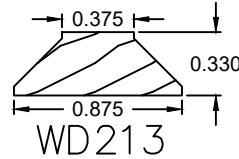
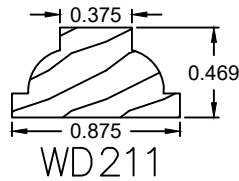
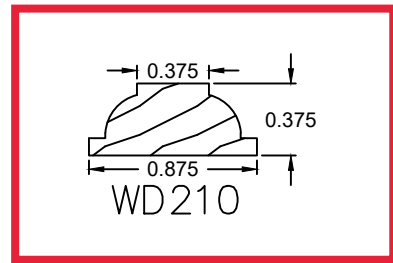
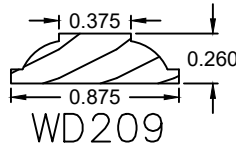
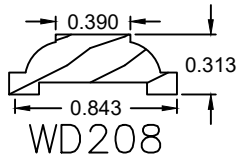
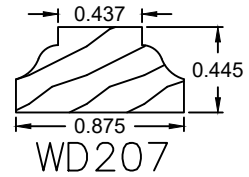
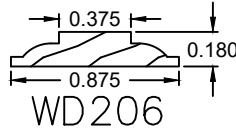
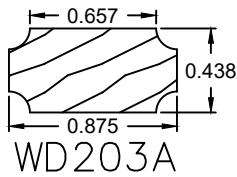

* Currently no radius bars are available for this profile.

Fastening Systems

Concealed Clips



For use with surround wood grilles

Metal clips that insert between the glass and the glazing bead (interior stop) and reveal a tension-mount clip designed to receive the surround profile of a full surround grille. The clips are completely concealed from view once the grille is installed.

Push Pins & Grommets



For use with surround wood grilles

Grommets are pre-drilled and installed into the surround perimeter at the factory. The push pins fit through the grommets. The grille is secured by pushing the pins into the wood sash or glazing bead.

Slide Pins



For use with non-surround wood grilles

Slide pins travel in channels that are pre-cut into the ends of each grille bar. The pin is pushed into the wood sash or glazing bead to secure the grille. For interior grilles only.

3M™ Dual Lock™

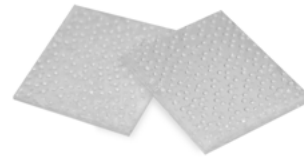

For use with surround and non-surround wood grilles

Pre-cut interlocking tabs are applied by sticking the tabs to both the grille and glass. Specially designed mushroom heads keep the grille in place.

Double-Sided Tape



For use on SDL (Simulated Divided Lite) grilles

The tape is pre-applied to the grilles. The grilles are then applied directly (and permanently) to the glass. *Black only.*

DOUBLE-SIDED VBH TAPE IS RECOMMENDED - THIS IS WHAT WINDOW MANUFACTURERS USE TO AFFIX SIMULATED DIVIDED LITES TO GLASS

Replacement fasteners are available for individual purchase on our website.



How to Measure

Please contact us toll free at
855-318-5022 or
orders@bigbluewindow.com
for a additional help.

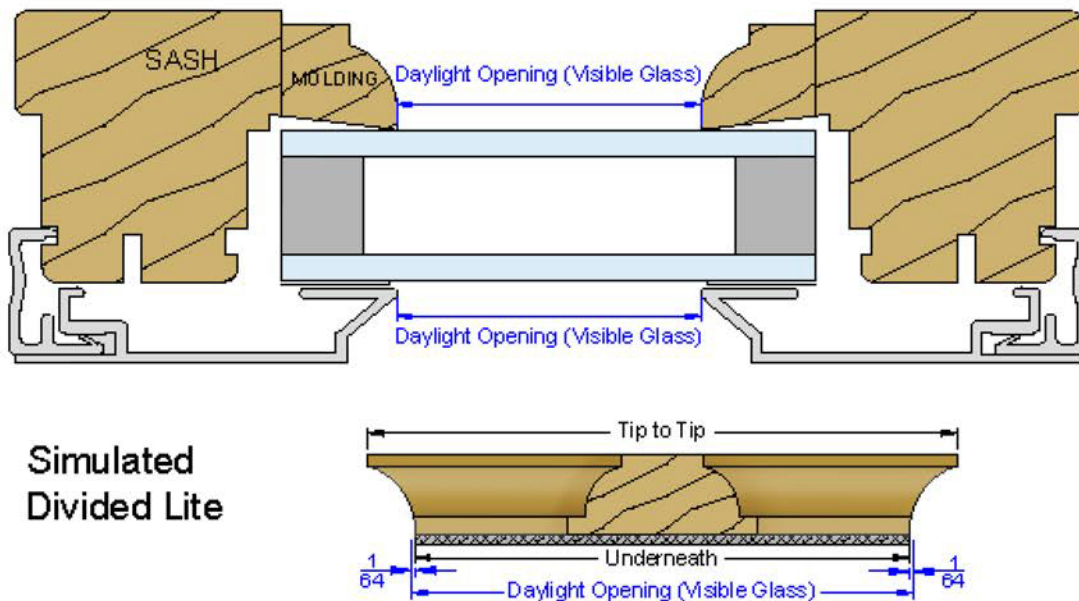

How to Measure for Simulated Divided Lite (SDL) Grilles

Measurements must be taken on the inside and the outside of the glass.

- To measure **Daylight Opening (DLO)**, measure the visible glass, from stop to stop.
- To measure the **Tip-to-Tip** dimension, measure the longest part of the grille on the top of the profile (the portion that faces outward from the glass).
- To measure the **Underneath** dimension, measure the shortest part of the grille bar, on the bottom of the profile (the portion that touches the glass).

UNLIMITED POSSIBILITIES
TO CREATE YOUR ORIGINAL

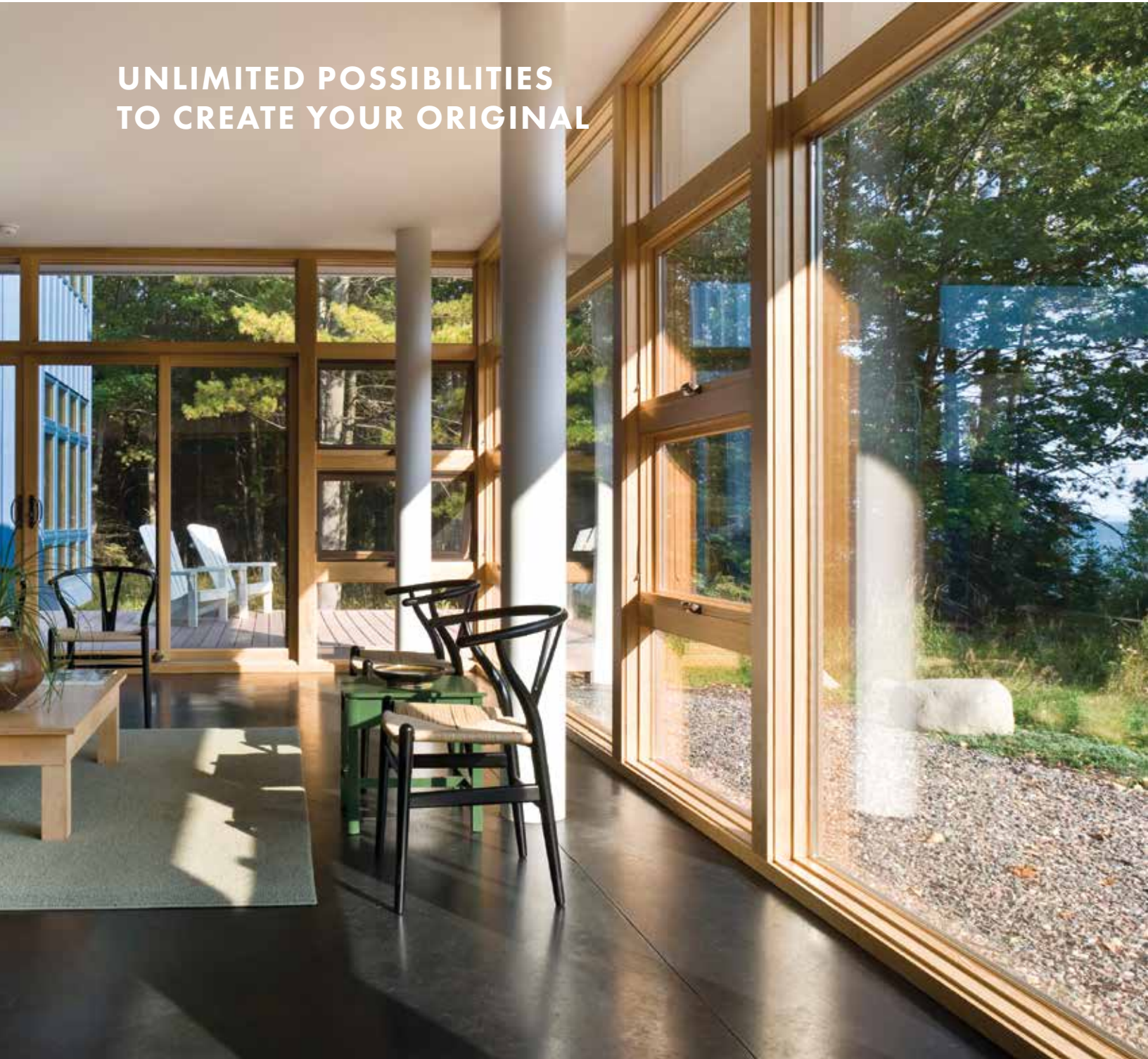

DO YOU DREAM IN COLOR?

While our large selection of 50 exterior colors covers a lot of ground, inspiration comes in infinite hues. Let us match a paint chip, a photograph or a favorite work of art to bring your dream color into the light of day. Or, choose from a selection of anodized finishes for a rich, lustrous metallic appearance that cannot peel or flake and is not affected by sunlight.*

EXTERIOR COLORS



7 ANODIZED FINISHES

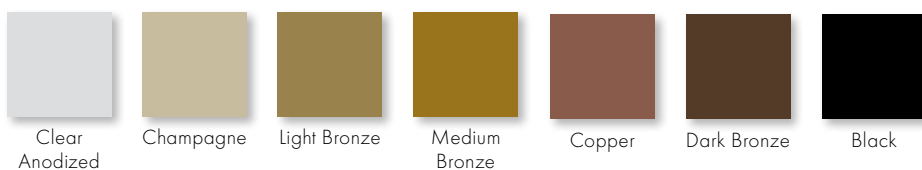

Design your window at
andersenwindows.com/design-tool

CUSTOM EXTERIORS OR 2-, 3- AND 4-TONE EXTERIORS

Choose a custom exterior color to get just the right color for your design. And, with our 2-, 3- and 4-tone color combinations, the sky's the limit. Mix and match up to four of our 50 exterior colors for a combination look that's all your own.



Colony white and black

EXTERIOR TRIM

Choose exterior trim in either a flat casing, brick mould or sill nosing profile to add curb appeal to your home.



2" brick mould and 1 1/2" sill nose, shown on a casement window

*Visit andersenwindows.com/warranty for details. Printing limitations prevent exact color duplication. Please see your Andersen supplier for actual color samples.

ARCHITECTURALLY AUTHENTIC GRILLES

We offer a variety of grille styles and patterns to choose from, or design your own with varying lines, curves and shapes.

FULL DIVIDED LIGHT

Features permanent interior and exterior grilles with grille spacer bars between two panes of insulating glass. A traditional divided light look with modern energy efficiency.

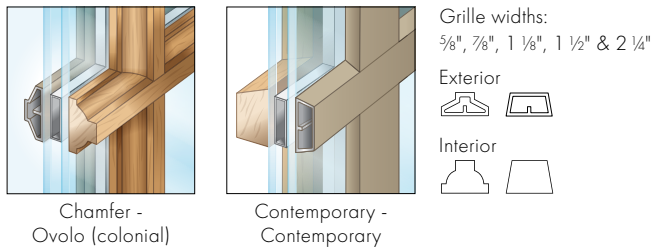

SIMULATED DIVIDED LIGHT

An economical solution featuring permanent interior and exterior grilles without grille spacer bars.

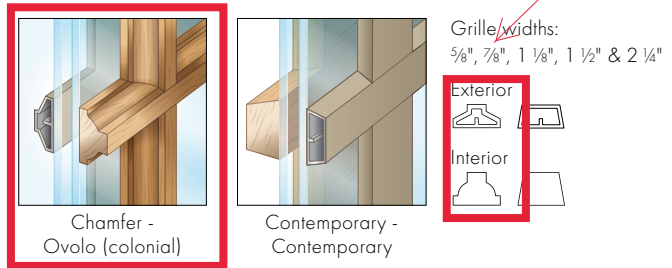

REMOVABLE INTERIOR WOOD GRILLES

Removable interior wood grilles. Available with optional surround and an optional permanent exterior grille, shown to left below.

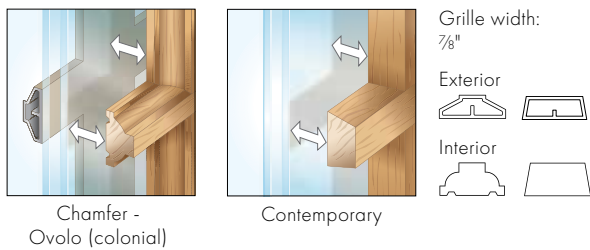

FINELIGHT™ GRILLES-BETWEEN-THE-GLASS

Aluminum grilles conveniently placed between two panes of glass for easy cleaning inside and out.

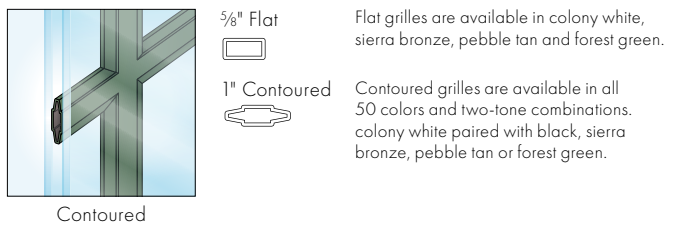

SCREEN OUT THE INSECTS, NOT THE VIEW

E-Series insect screens let the beauty of the outdoors in, while keeping even small insects out. Choose from a wide selection of insect screen styles, including options that blend seamlessly with your window.

TRUSCENE® INSECT SCREENS*

TruScene insect screens for windows are made with a micro-fine stainless steel mesh that offers 50% more clarity than our conventional aluminum mesh insect screens. TruScene insect screens let in 25% more fresh air;† all while keeping out unwanted small insects.

WOOD VENEER INSECT SCREENS

For a clean appearance, E-Series interior window insect screens can feature a wood veneer to blend into your window.

RETRACTABLE INSECT SCREENS FOR WINDOWS AND PATIO DOORS

Retractable insect screens for casement and awning windows offer a sleek addition to any home. In place, the insect screen keeps insects out. When retracted, it provides a beautiful clear view.

For patio doors‡, retractable insect screens are built with an innovative color-matched housing that hides the insect screen when not in use. It's there when you need it and gone when you don't.



Retractable insect screen for casement and awning windows.

*TruScene wood-veneered insect screens utilize a different frame profile than other E-Series wood-veneered insect screens.

††TruScene insect screens let in over 25% more fresh air than standard Andersen fiberglass insect screens.

‡Retractable insect screens are available on hinged inswing, hinged outswing and gliding patio doors. See your Andersen supplier for details.

THE MARVIN PORTFOLIO

The Marvin portfolio is organized into three product collections, each defined by degree of design detail, flexibility, and customization opportunities.

Curated solutions provide exceptional performance, energy efficiency, low maintenance, and long-lasting quality you can see, feel, and touch.

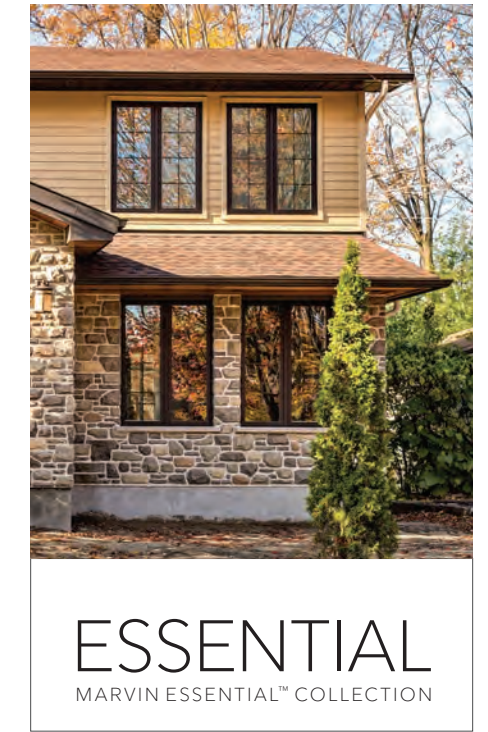

SIZING

Custom sized windows and doors built to your home's exact specifications

DESIGN FLEXIBILITY

The highest level of design flexibility with the most extensive offering of options

Wide range of design options with prompt delivery for quicker-turn projects

Tailored set of design options with accelerated delivery

INTERIORS

Wood interiors with six species options. Factory finish in White or Designer Black paint, six stains, clear coat, or primed for custom painting

Wood interiors. Factory paint in White or Designer Black, bare wood for painting or staining, or clear coat

Low-maintenance fiberglass interiors in White, Ebony, or Bronze

EXTERIORS

Long-lasting, low-maintenance exteriors with best-in-class finishes for superior durability

Long-lasting, low-maintenance exteriors with best-in-class finishes for superior durability

Extruded Aluminum (19 colors or custom color) or Wood exteriors (four species)

Extra durable Ultrex® fiberglass exteriors in six color options

HARDWARE

Extensive selection of window and door hardware including Gallery Hardware

Window and door hardware in six finish options
Two door hardware styles

SCREENS

Stained/painted wood, or color matched aluminum surrounds

Stainable interior wood or color matched surrounds

Color matched surrounds

+ OPTIONS

Concealed sensors for security systems, Wash Mode

COASTAL + WATERFRONT

All Marvin windows and doors are well suited for coastal or waterfront areas, with special products and hardware specifically designed for hurricane zones

EXTERIOR COLORS + MATERIALS

STONE WHITE

COCONUT CREAM

SIERRA WHITE

CASHMERE

PEBBLE GRAY

HAMPTON SAGE

CADET GRAY

CLAY

CASCADE BLUE

SUEDE

GUNMETAL

WINEBERRY

BRONZE

BAHAMA BROWN

EVERGREEN

EBONY

BRIGHT SILVER (PEARLESCENT)

COPPER (PEARLESCENT)

LIBERTY BRONZE (PEARLESCENT)

CUSTOM COLOR: ANY COLOR YOU WANT

Complement any project or design with our high-quality exterior options. Choose from extruded aluminum or wood.

EXTRUDED ALUMINUM

Extruded aluminum is an extremely tough cladding that protects wood windows, mimics the profiles of wood, and provides superior durability.

Select a color from our palette of 19 durable extruded aluminum colors, including a spectrum of rich hues and three pearlescent finishes. If you have more specialized needs, we can work with you to create a custom color.

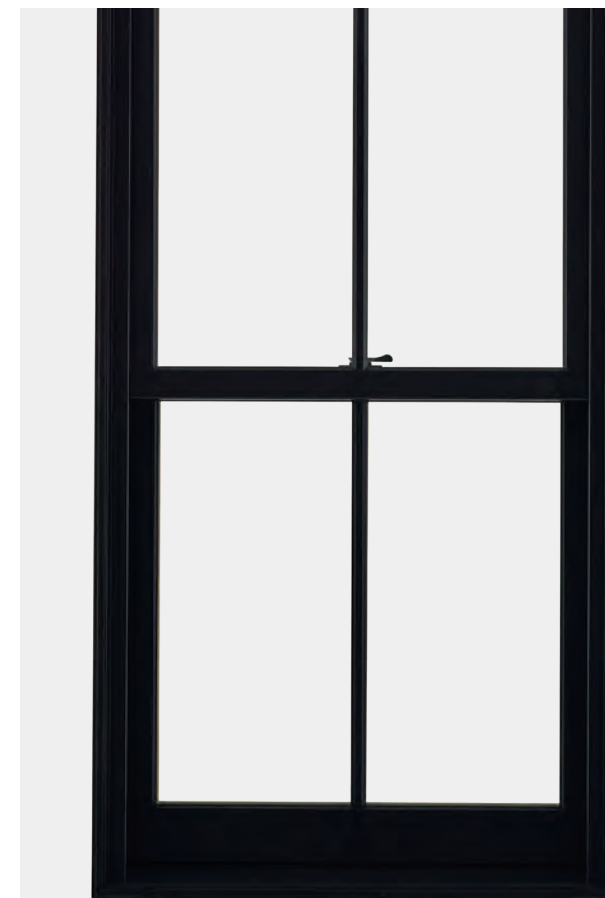

Ultimate Double Hung G2 window in Ebony

Ultimate Double Hung G2 window in Suede



WOOD EXTERIORS

Wood is a premium material for windows and doors, offering classic aesthetic appeal, many options for customization, and design versatility.

We treat exposed millwork with a water repellent wood preservative to help it last longer. Choose from one of four exterior options. Each is ready to be finished to match your project's exacting requirements.

PINE

VERTICAL GRAIN
DOUGLAS FIR

MAHOGANY

WESTERN RED CEDAR
Exterior trim package only

DIVIDED LITES



Photo: Laurey W. Glenn

Ultimate Sliding French door and Ultimate Double Hung G2 windows with Simulated Divided Lites



Endless Design Possibilities

Our custom capabilities allow us to create almost any divided lite pattern to match your design style. Divided lites can feature an array of widths, unique profiles, rectangular or curved cuts, and more. Choose from an existing lite cut or specify custom divided lites according to a new design.

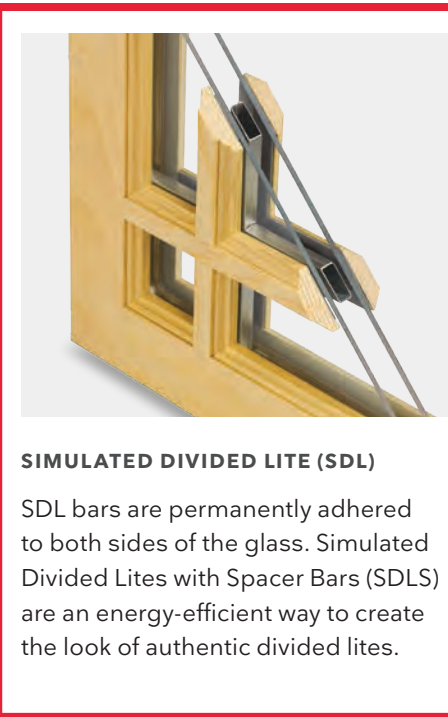

SIMULATED DIVIDED LITE (SDL)

SDL bars are permanently adhered to both sides of the glass. Simulated Divided Lites with Spacer Bars (SDLS) are an energy-efficient way to create the look of authentic divided lites.



AUTHENTIC DIVIDED LITE (ADL)

Separate panes of glass are glazed between bars—the way windows have been made since the beginning. Available exclusively with wood exterior units.

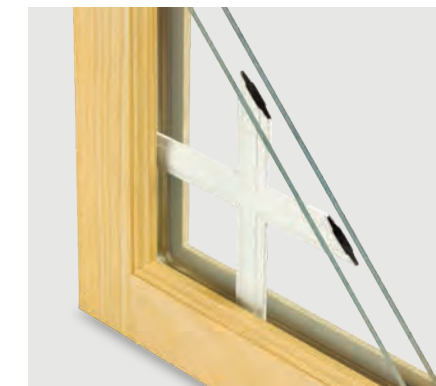

GRILLES-BETWEEN-THE-GLASS (GBG)

Grilles are permanently installed between the glass panes. This low-maintenance grille offers the look of a divided lite pattern with the ease of cleaning just one pane of glass. Available with different interior and exterior colors.

STICKING AND PROFILES

Sticking refers to the interior profiles of your wood window. Choose from the standard Ogee profile (used on traditional projects) or the optional clean, contemporary Square sticking.



Ogee



Square



Square sticking

FIVE STANDARD BAR WIDTHS

Ogee:

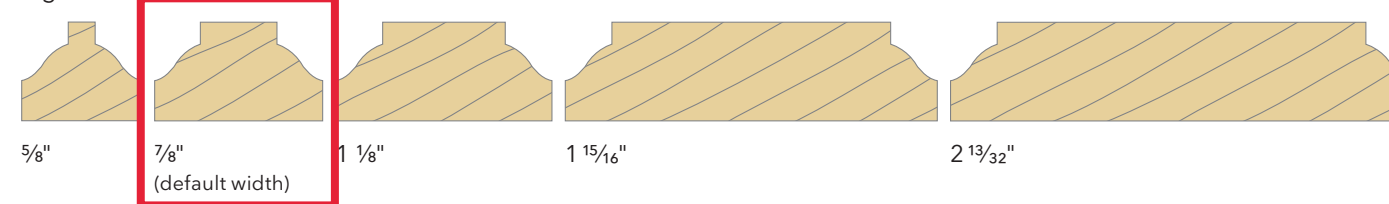

Square Sticking:

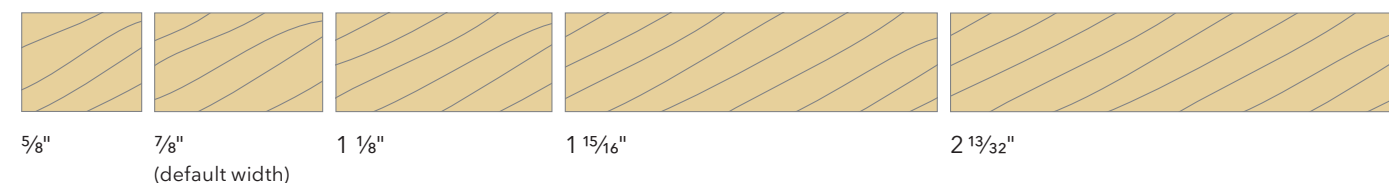

GLASS

DUAL PANE VS. TRIPLE PANE



DUAL PANE

Our standard glazing is dual pane: two panes of glass with Low E coatings and insulated with argon gas. Compared to a single glass pane, dual pane glass cuts heat loss significantly because of the insulating space between the glass layers.



TRIPLE PANE

Triple Pane glazing provides three panes of glass with Low E coatings. Two glass spaces are insulated with argon gas between the panes.

TRIPLE PANE: IS IT RIGHT FOR YOU?

While Marvin triple pane windows are engineered for long-lasting energy efficiency, not all windows are made the same. Simply having three panes of glass doesn't necessarily mean a triple pane window is more energy efficient. Glass coatings, the type of gas used in the spaces between the glass, the design of the window, the materials used, and how well it is installed all play a role in achieving the overall energy efficiency. Consider the energy efficiency of the entire window, not just the number of panes.

A poorly designed or installed window, or a window made with inferior materials like vinyl, may not be energy efficient regardless of the number of panes of glass. Materials shrink and expand with cold/heat cycles and seals can begin to fail. Once seals fail, the energy efficiency the window claimed when it was new becomes greatly reduced. Consider your home's unique needs before assuming that triple pane, or tripane, is always the best solution.

Visit marvin.com/energyratings to view detailed performance ratings for all Marvin products.

COATINGS & ENERGY EFFICIENCY

Low E coatings are a microscopically thin, virtually invisible metallic layer on the glass surface that help manage the amount of heat either radiated through a window or reflected away from it. Marvin products are offered with a variety of Low E coating options for thermal performance best suited for your heating and cooling needs.

The national ENERGY STAR® program recognizes products that meet strict energy efficiency guidelines to suit climates in different areas of the country. No matter where you are located, we offer energy efficient solutions that meet or exceed ENERGY STAR guidelines.

Visit marvin.com/energy for more information.

- LOW E1** Single layer of metallic coating, which reduces heat loss to the outside while allowing the highest levels of solar heat into a room. Generally used in Northern climates where heating is prioritized over cooling.
- LOW E2** Double layer of metallic coating. Provides year-round performance and comfort, and works well in most geographic regions and climates where a mix of heating and cooling is required.
- LOW E3** Triple layer of metallic coating provides the most protection against solar heat gain (warmth from the sun). Most commonly used in climates where sun exposure is intense and cooling is a priority.
- LOW ERS** A high-performance insulating glass option that features a Low E coating on the Room-Side glass together with a coating of Low E2 or Low E3 on the second glass surface. This option is designed to reflect radiant heat back into the room. It is not recommended for some northern zones as condensation is more likely to occur.

DECORATIVE + SPECIALTY GLASS OPTIONS

Glass goes beyond energy efficiency. Decorative and privacy glass, and even specialty glass that provides additional sound reduction, can be paired with thermal performance options for a window or door that is perfect for your home.

DECORATIVE GLASS

Decorative glass options on Ultimate windows and doors are offered with your choice of Low E coatings for energy efficiency and your own unique style.

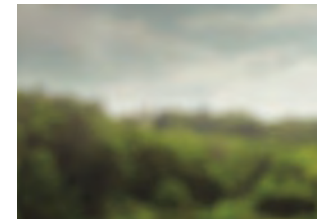

BRONZE TINT



GRAY TINT



GREEN TINT



BEVELED



OBSCURE



FLEMISH



GLUE CHIP

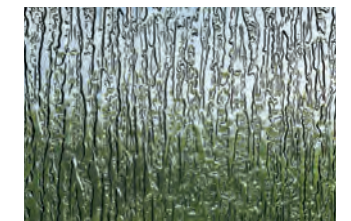

RAIN

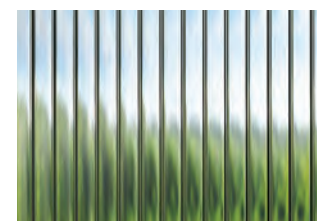

REEDED

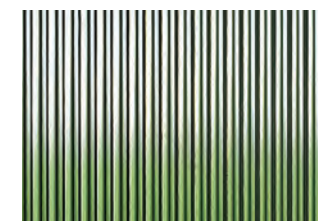

NARROW REED



AQUALITE



WHITE LAMINATED

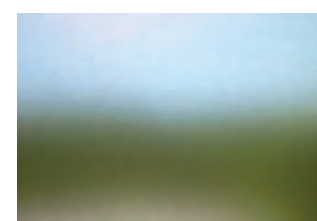

SANDBLASTED



LEADED



V-GROOVE

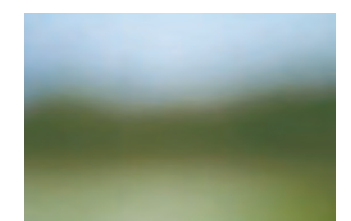

FROST

SPECIALTY GLASS

Our specialty glass options include glazing for unique project requirements like sound reduction, high altitudes, Sea Turtle Conservation Codes, and California fire zones. We also offer laminated glass in products designed specifically for hurricane zones.

DIVIDED LITES

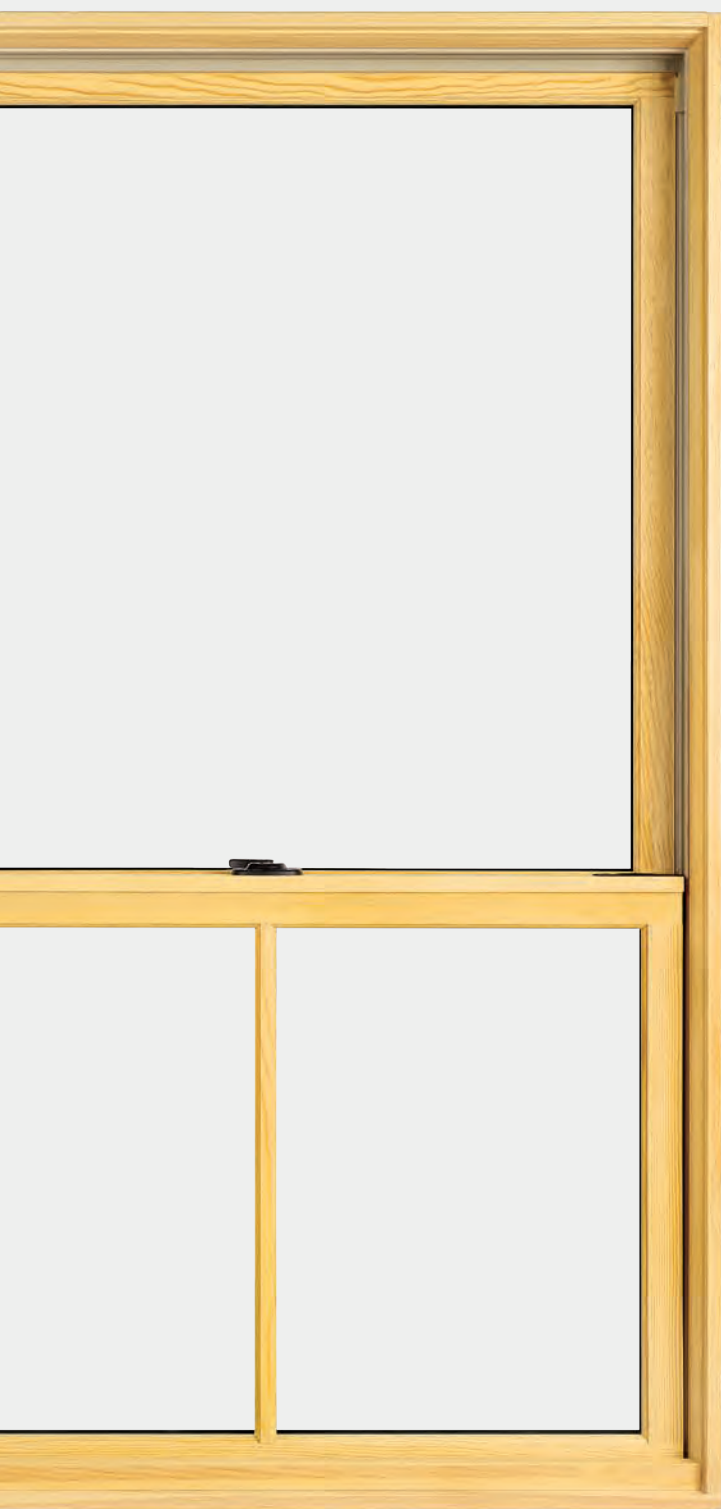

SIMULATED DIVIDED LITE (SDL)

A simulated divided lite (SDL) is an energy-efficient way to create the look of authentic divided lites. SDL bars are permanently adhered to both sides of the glass. Spacer bars can be installed between the bars inside the glass, creating the look of individual panes.

- Available on Elevate products

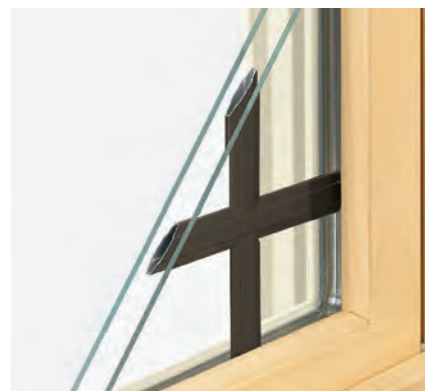

GRILLES-BETWEEN-THE-GLASS (GBG)

Low-maintenance grilles offer the look of a divided lite pattern with the ease of cleaning just one pane of glass. Exterior colors match Ultrex® fiberglass exteriors, and a selection of interior colors match or complement interiors.

- Available on both Elevate and Essential products



SIMULATED CHECKRAIL

The simulated checkrail is the perfect solution when your home style calls for the look of a double hung window, but operation, egress, or performance demand another solution. Essentially, it gives a casement window the look of a double hung.

With custom placement anywhere on the window and paired with 7/8" divided lite bar patterns above and below, this option offers wonderful flexibility for creating a unique look that's perfect for your home. Available on Elevate Casement, Awning, and Glider windows and all Elevate doors.

- Available on Elevate products

PATTERNS

These illustrations offer a sampling of Simulated Divided Lite (SDL) patterns that can be selected on Elevate windows and doors. Enjoy exceptional design flexibility by combining standard 7/8" bars with the 2 1/32" Simulated Checkrail.

