

STAFF REPORT: 04-10-2021 REGULAR MEETING

PREPARED BY: A. DYE

APPLICATION NUMBER: 21-7190

ADDRESS: 85 CHICAGO

HISTORIC DISTRICT: BOSTON-EDISON

APPLICANT: BIBIANA NARCISSA

PROPERTY OWNER: BIBIANA NARCISSA

DATE OF PROVISIONALLY COMPLETE APPLICATION: 03-22-2021

DATE OF STAFF SITE VISIT: 03-26-21

SCOPE: REPLACE CLAY TILE ROOF WITH NEW METAL ROOF; WRAP SOFFITS & FASCIA IN ALUMINUM

EXISTING CONDITIONS

As reproduced from the March 10, 2021 Staff Report:

Erected in 1915, the Italian Renaissance architectural styling of the two and one-half story structure offered a respite from the at-times opulently-designed residential architecture dominant in this neighborhood in the early 20th century. As shown in the circa 1920 photograph, the relatively smooth-faced stucco walls served a blank canvas against which the six-over-one double-hung windows and boxed out bay window were placed. The house offers many divergences in design: deep overhanging boxed-out eaves on the second floor contrast the shallower open eaves on first floor; the continuous windows on the box bay contrast the solidness of the main body of the house with its individually placed (or occasionally mullied) windows; the unadorned stucco walls contrast the highly ornamental arched and bracketed front entrance portico. Bump-outs of differing sizes and shapes are evident, and include the front elevation box bay, a small bay window on the east/side elevation, a two-story massing that anchors the southeast corner of the house, a rear entry and a single-story flat-roofed attached garage.

The dimensionality, patterning, profile and saturation of color of tile roofs make them character-defining features of a building. At this residence, the use of green barrel tiles (as opposed to flat shingle or shake tiles) offers the final and most dramatic contrast against the minimal ornamentation of the stucco walls. When comparing the circa 1920 photograph to the 1974-1980 photographs, and then those from 2021, a gradual loss of architectural details is noticed and include the exposed rafters on the box bay, iron railings at the front entry as well as those enclosing the front elevation French door, the gutter collector boxes and many of the six-over-one windows.

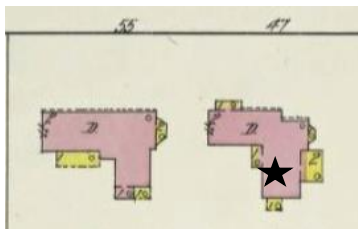

Above: Sanborn Map Company, Vol. 9, 1915
Above Top Right: Left: Photo from *Beautiful Homes of Detroit and Vicinity, circa 1920.*
Right: Designation Photo, 1974, HDAB



HDC Staff Photos,
March 2021



At the March 10, 2021 HDC meeting, the Commission denied the installation of the proposed Great American Shake Metal Roof Shingles, color: Weathered Cedar. The Commission approved the repair of the existing wood roof deck and replacement of the roof underlayment. The applicant was asked to identify a roofing material more consistent with the character of the removed clay tiles, which were a distinctive, character-defining feature.

PROPOSAL

Roof

The applicant proposes to install Isaiah Industries, Classic Metal Roofing System, GrandeTile, color: not known.

Manufactured from industrial grade .092” aluminum alloy

Panel Exposure – single course panel is 13.75”; double course panel is 27.75”

Weight Per Square: 67 pounds

Finish: Baked on protective primer, and Kynar 500 or Hylar 5000 PVDF topcoat

Additional Roofing Materials: color-matching silicone sealant, underlayment, pipe flashing and stainless steel screws.

○ Lifetime warranty on GrandeTile panels – provided by Isaiah Industries

○ Lifetime warranty on labor and installation – provided by Alexandria Windows, Doors, Metal Roofing, LLC
Synthetic ice and water underlayment will be installed on entire roof deck (required for lifetime labor and installation warranty)

Soffit and Fascia

Remove existing wood fascia and soffit; install new wood fascia and soffit with common pine boards

Install aluminum-cladding over new fascia boards, manufacturer: Quality Aluminum Products, color: bronze

Gutters/Downspouts

Manufacturer: Quality Aluminum Products

Color: bronze

Collector boxes

K & M Sheet Metal, “The Federal”, each box is 13” wide, 8-7/8” deep, 9-1/2” – 10-1/2” high

Color: bronze

STAFF OBSERVATIONS AND RESEARCH

- The Boston-Edison Local Historic Business District was established in 1974.
- HDC staff has looked more closely at the photographs previously submitted by the applicant and noted distinct color lines appear on the top of exposed tiles, leading staff to speculate the tiles had been painted green at some point in time. Furthering this point is staff’s understanding that colored tile goes through the following process, as described on Ludowici’s website: “. . .color glazes are kiln-fired at extreme temperatures during production, fusing the color into the tile and ensuring that the original tones and hues are retained for generations.”



- While a page of three colors – winter oak, mahogany and maple were submitted by the applicant, these colors are not shown on the manufacturer’s brochure. The property owner confirmed with staff the tile color has not been selected.
- The shed roof on the front elevation bump-out is currently covered in rolled roofing. According to Google Street View, the tiles were removed between July 2009 and August 2011.
- Staff doesn’t dispute the visible condition of the soffit and fascia shows areas of severe deterioration that warrants replacement. Staff does dispute the proposal to wrap the new wood soffit and fascia with aluminum (which is further discussed under “Issues”).
- The collector boxes disappeared from the house at some point in time. The applicant proposes to install new collector boxes as part of the gutter/downspout installation. While the proposed boxes have a less detailed profile than the previous ones, the design is a contemporary and sympathetic solution



ISSUES

- There seems to be a discrepancy between the hip/ridge components when comparing photographs of installed GrandeTile roofs, as the photo on the left shows a smooth hip while the photo on the right shows a hip product with bump-outs that more closely simulate clay tile hip pieces. It is staff’s opinion, should the Commission approve the GrandeTile, the hip and ridge pieces have the profile as seen in the photo on the right.



- The GrandeTile profile is more akin to a wave, than a barrel, as seen below. (Photo on the right is 85 Chicago) As the tile roof was a character-defining feature, the Commission needs to consider if the new material offers a close enough dimensionality and pattern to the tile per Standard #6, “*Deteriorated historic features shall be repaired rather than replaced. Where the severity of deterioration requires replacement of a distinctive feature, the new feature shall match the old in design, color, texture, and other visual qualities and, where possible, materials.*”



- The existing wood soffit emphasizes the horizontality and deep overhang of this roofing component. The long lines of the parallel-placed wood boards are minimally evident, and once painted almost disappear to create a flat surface. Installing a product, regardless of material, that has grooved joints drastically changes the appearance of the soffit and draws attention to this area of the house that was meant to be a secondary visual component. The fact that the proposed material has perpendicular grooved lines will create a more distracting geometrical clash against the curves of the proposed roof. As staff



stated opinion in the opening architectural description, this house was designed with contrasting features in which most surfaces were left unadorned and “pops” of detail (tile roof, ornate front entry overhang) were added as contrast in strategically defined areas.

- Wrapping the fascia in aluminum, in contrast to wrapping the soffit, will remove detail on the gable ends of the house where the rakeboards have a profile, and will introduce a generally inappropriate material in a context where matching material is readily and feasibly available.



RECOMMENDATION

Section 21-2-78, Certificate of Appropriateness

Recommendation One

It is staff’s opinion the wrapping of the soffit, fascia and rakeboard will alter the features and spaces that characterize the property. Staff therefore recommends the Commission deny a Certificate of Appropriateness for the work as proposed because it does not meet the Secretary of the Interior Standards for Rehabilitation, specifically Standards:

- 2) The historic character of a property shall be retained and preserved. The removal of historic materials or alteration of features and spaces that characterize a property shall be avoided.*
- 6) Deteriorated historic features shall be repaired rather than replaced. Where the severity of deterioration requires replacement of a distinctive feature, the new feature shall match the old in design, color, texture, and other visual qualities and, where possible, materials. Replacement of missing features shall be substantiated by documentary, physical, or pictorial evidence.*

Recommendation Two

It is staff’s opinion the installation of the proposed metal barrel roofing tile is a reasonable and feasible solution in an effort to retain a highly dimensional roof, thus not greatly altering the features and spaces that characterize the property. Additionally, the proposed gutters, downspouts and collector boxes are sympathetic to those that were on the house. Staff therefore recommends the Commission issue a Certificate of Appropriateness for the work as proposed because it meets the Secretary of the Interior Standards for Rehabilitation.

Staff recommends the Certificate of Appropriateness be issued with the following conditions:

- Tile be installed on all of the roof surfaces, including the front elevation shed roof, that offers a 3:12 or greater roof pitch.
- The hip roof pieces shall have the profile that simulates natural clay hip pieces (it will not be smooth).
- HDC staff requests the authority to review and approve the final roofing color.

Applicant Photos – 2-15-21
APPLICANT PHOTOGRAPHS



Applicant Photos – 2-15-21





Applicant Photos – 2-15-21



Applicant Photos – 2-15-21



Applicant Photos – 2-15-21



Applicant Photos – 2-15-21



Applicant Photos – 2-15-21





Corner 9-10



Soffit Chimney 9-10



Missing Tile Detail2 9-10



Missing Tile Detail 3 9-10



Roof 2 9-10



Roof Overhang 9-10



Front 3 9-10



Gable Side 9-10

March 20, 2021 Applicant Photos – Photo Names provided by applicant



Corner Details 9-10



Front Angle 9-10



Front 9-10



Front Windows 9-10



Front2 9-10



Garage 9-10

March 20, 2021 Applicant Photos – Photo Names provided by applicant



Rear 9-10

March 20, 2021 Applicant Photos – Photo Names provided by applicant



Missing Tile 9-10



Roof 9-10

March 20, 2021 Applicant Photos – Photo Names provided by applicant

APPLICANT PHOTOS – Photo names provided by applicant

March 20, 2021 Applicant Photos – Photo Names provided by applicant





March 20, 2021 Applicant Photos – Photo Names provided by applicant

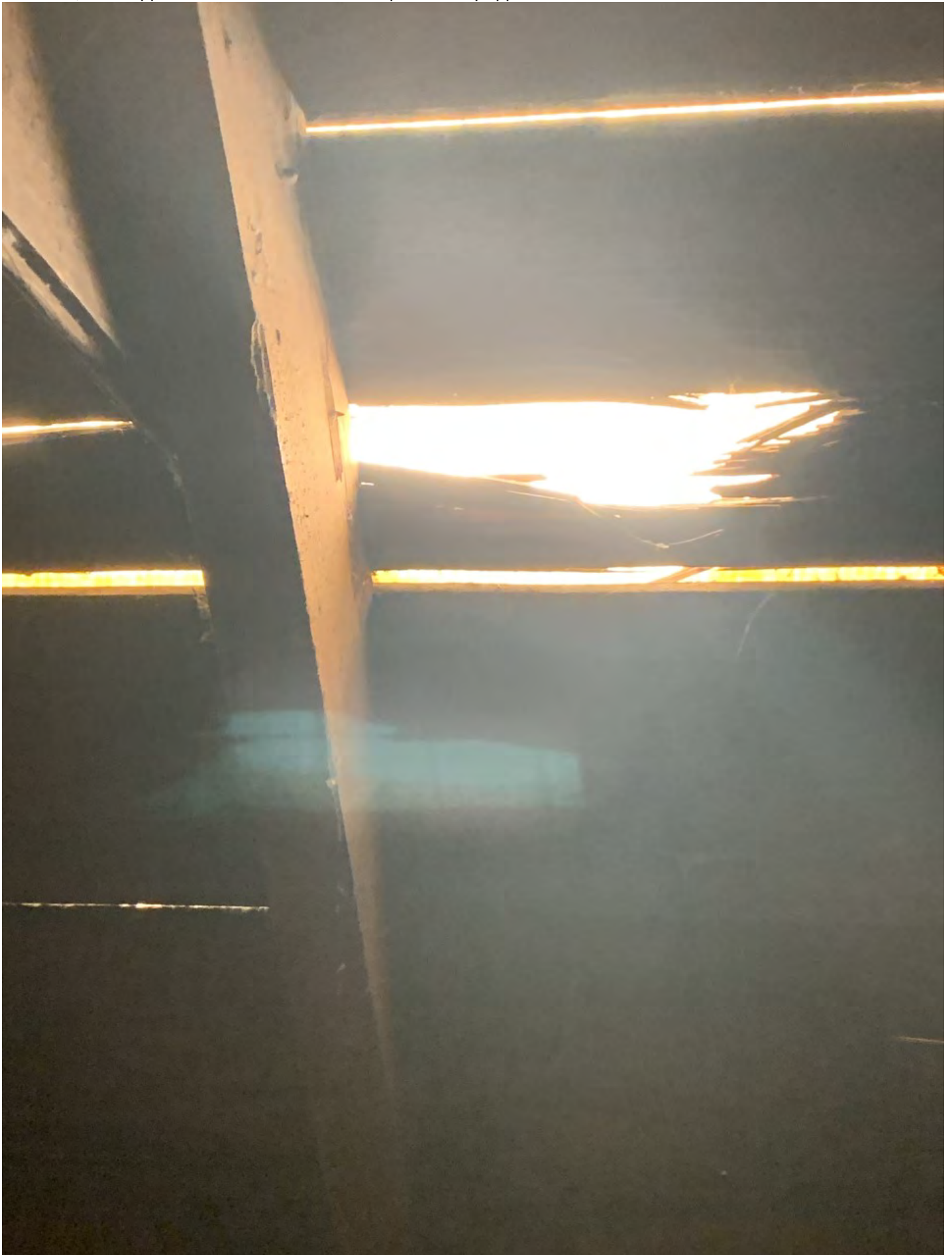

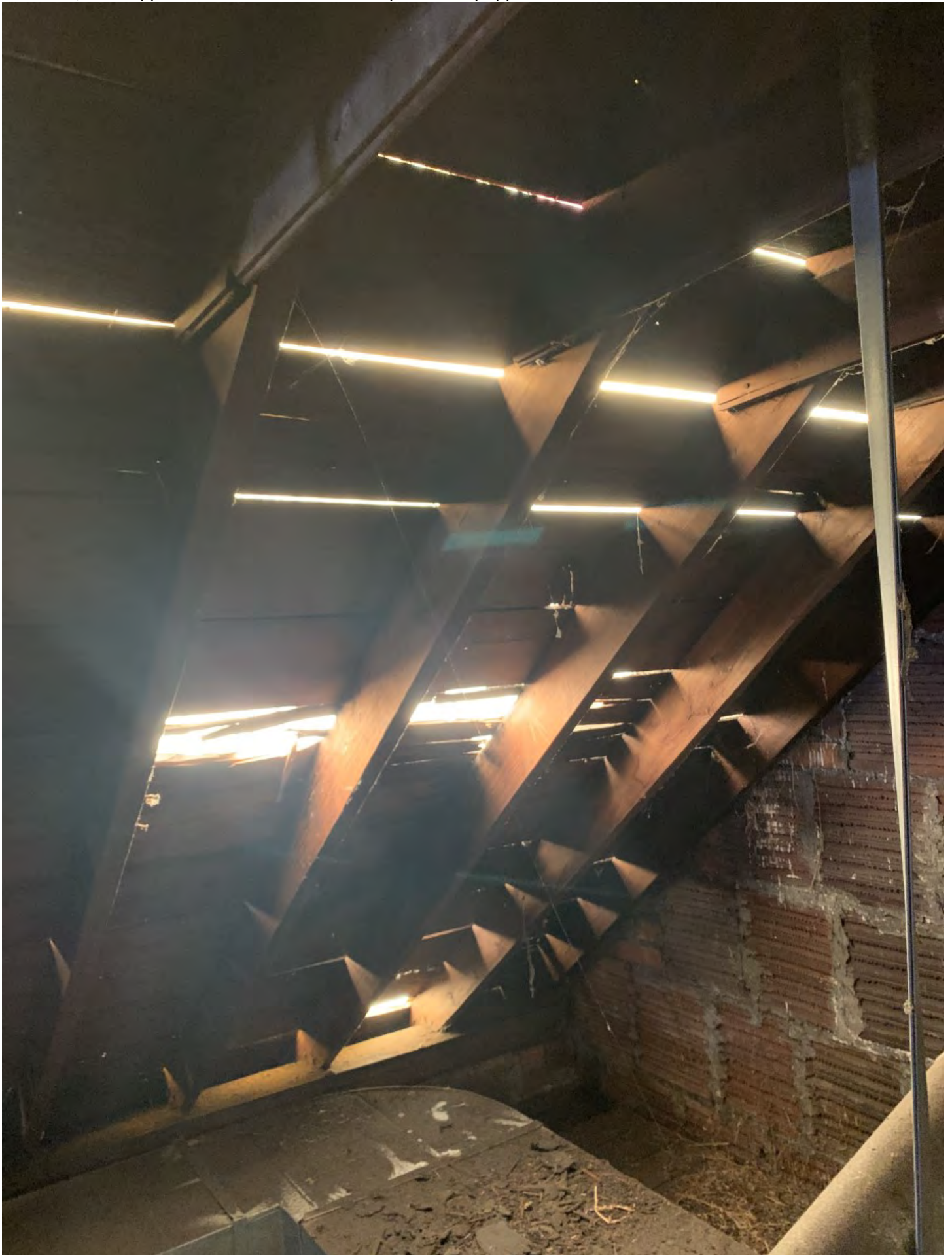

March 20, 2021 Applicant Photos – Photo Names provided by applicant



March 20, 2021 Applicant Photos – Photo Names provided by applicant



March 20, 2021 Applicant Photos – Photo Names provided by applicant



March 20, 2021 Applicant Photos – Photo Names provided by applicant



85 Chicago Boulevard

Prepared by Johnny Merehouyias

Alexandria Windows, Doors, Metal Roofing LLC



Proposals Approved on 3-10-2021

- Removal and replacement underlayments
 - New Underlayment manufactured by Isaiah Industries
 - Material made specific for Metal roofing, but any type of roof material can be installed over the underlayment.
 - Made to last beyond the life of the roof.
- Replacement of all rotted and broken roof sheathing boards
 - Boards will be replaced with new wood boards, not plywood.

Proposals Requiring Approval

- Removal and replacement of all remaining fascia boards.
 - Replaced with Common Pine Boards (non-specific manufacturing)
- Installation of aluminum clad over all newly installed fascia boards.
 - MFG: Quality Aluminum Products
- Removal and replacement of all remaining soffit boards.
 - Replaced with Common Pine Boards (non-specific manufacturing)
- Installation of aluminum soffits over all newly installed soffit boards.
 - MFG: Quality Aluminum Products
- Installation of new metal roofing system
 - MFG: Isaiah Industries (Classic Metal Roofing Systems)
- Installation of new gutter system
 - MFG: Quality Aluminum Products

Mold growth



Light is entering from holes where soffits are completely rotted out and birds are entering

Water stains



Water stains



Mold growth



Electrical wire
running over
water stained
wood boards



Broken Rafter Board



Water stains



Mold growth



Rotted
Sheathing Board

Water stains

Mold growth



Rotted Sheathing Board



Water stains

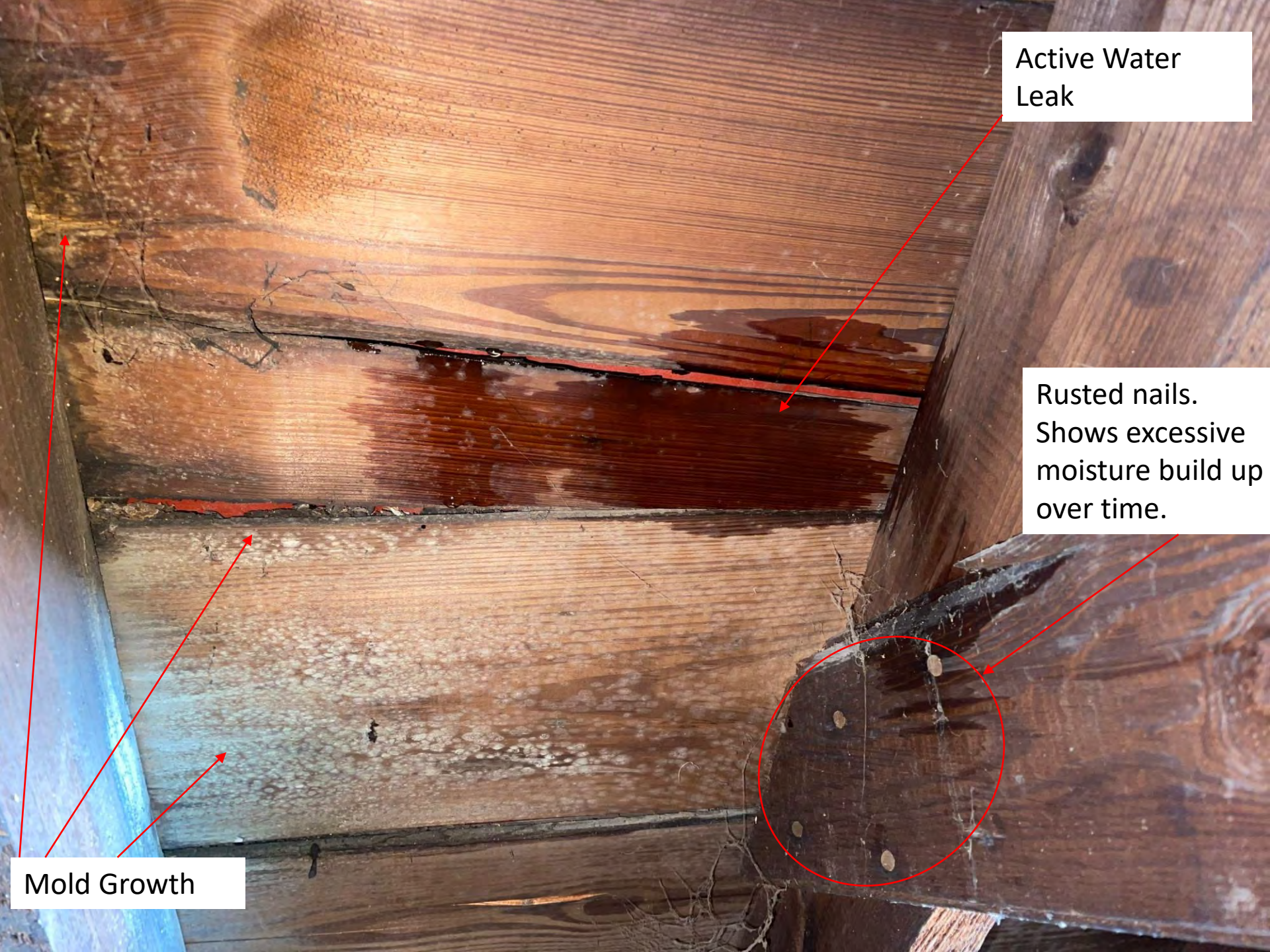

A close-up photograph of wooden planks. The top plank is dark brown with a prominent water stain. Below it, a lighter-colored plank shows signs of mold growth. A red circle highlights a nail on the right side that is heavily rusted. Red arrows point from text labels to these specific features.

Active Water
Leak

Rusted nails.
Shows excessive
moisture build up
over time.

Mold Growth

Mold Growth

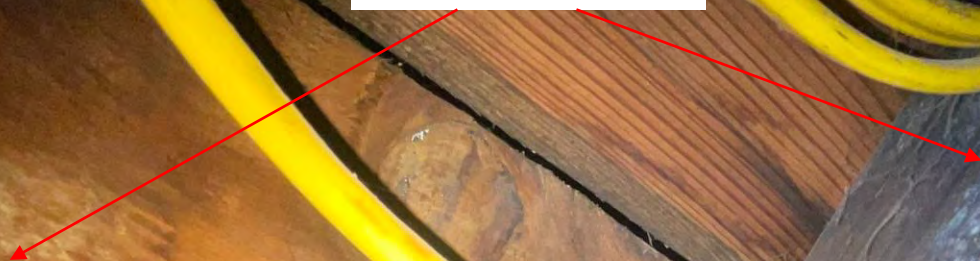

Water stains

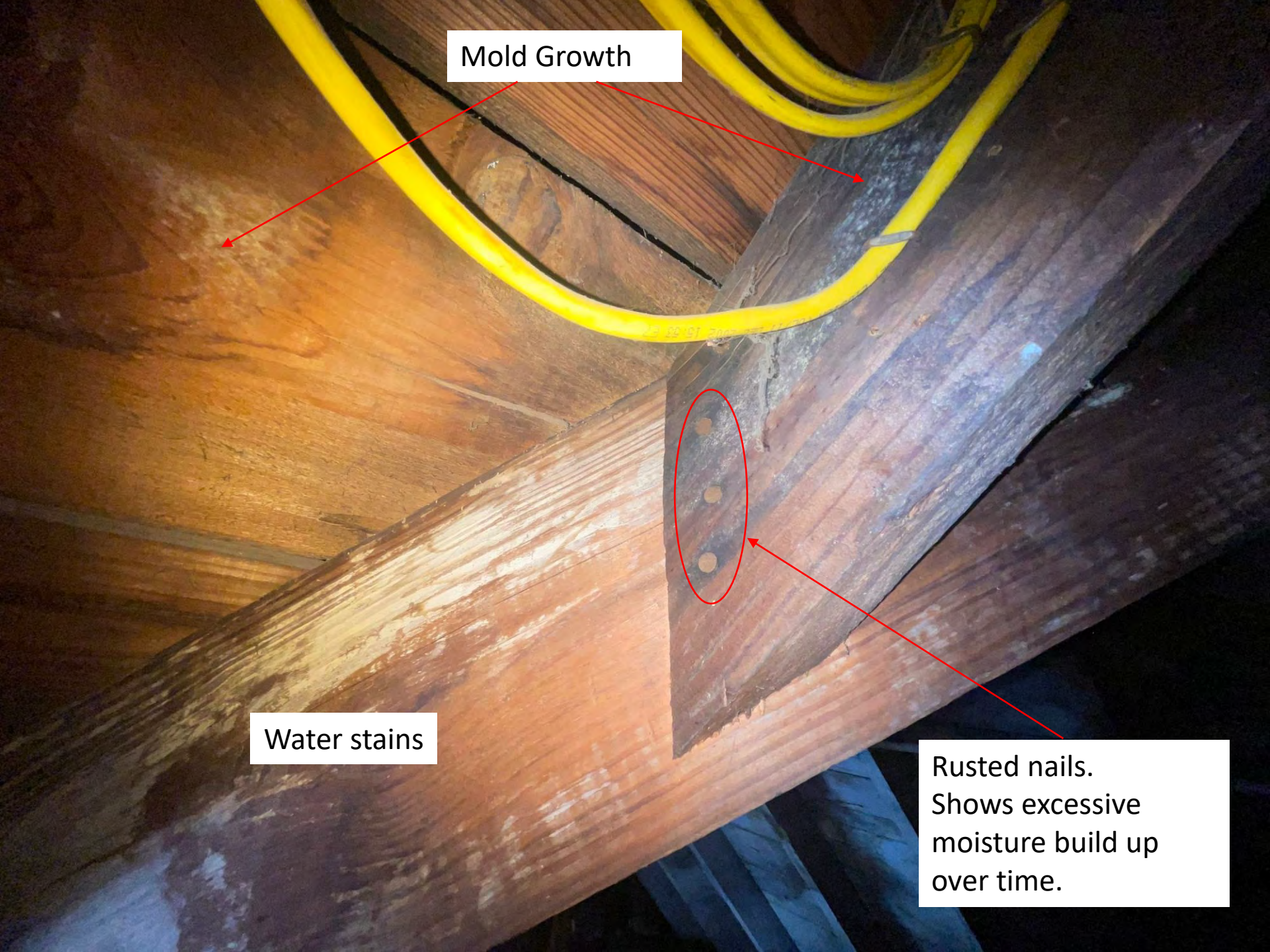

Rusted nails.
Shows excessive
moisture build up
over time.

Water stains

Mold Growth

Water stains



Light is entering from holes where soffits are completely rotted out and birds are entering



“Woodchips” are pieces of the rotted wood that has fallen off the sheathing or come from the soffits

Light is entering from holes where soffits are completely rotted out and birds are entering





Proposals Needing Approval (1/6)

- Removal and replacement of all remaining fascia boards.
 - Existing fascia boards are completely weathered beyond repair, and have been warped due to water leaks, inadequate sealing since their installation in 1915.
 - New boards will also be installed where existing boards have rotted away entirely and are no longer present.
 - New gutter system cannot be attached to the existing boards as there is nothing left to screw into.

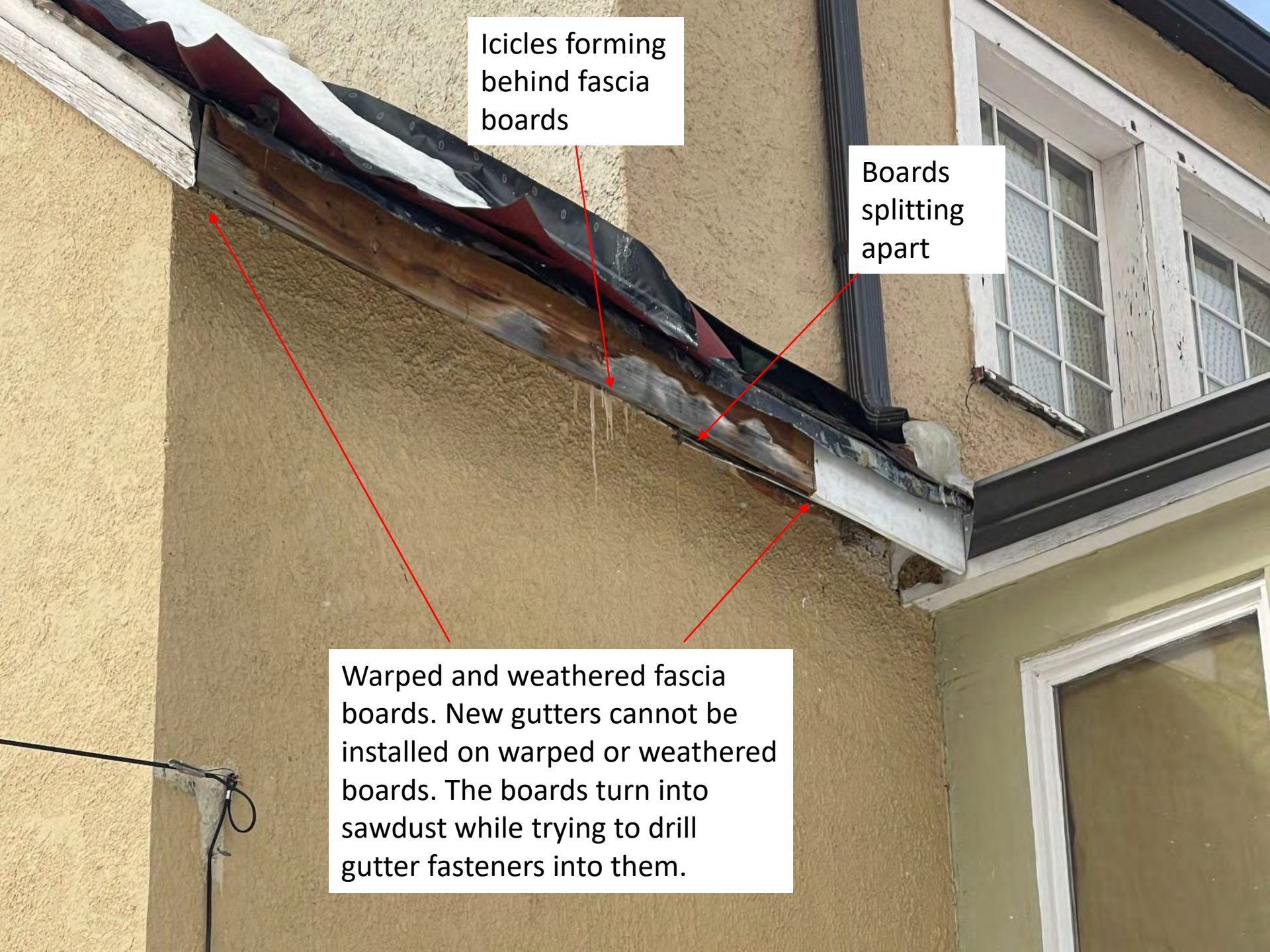

Icicles forming
behind fascia
boards

Boards
splitting
apart

Warped and weathered fascia boards. New gutters cannot be installed on warped or weathered boards. The boards turn into sawdust while trying to drill gutter fasteners into them.

Current Metal
Flashings
nailed onto
Fascia Boards





Current fascia boards
are warped and not
square anymore



New fascia boards will be installed so water flows into the gutters, not behind gutters.

Existing fascia boards have had constant contact with water for the past 106 years and are weathered beyond repair.

Current Metal
Flashings
nailed onto
Fascia Boards

Missing fascia boards
where gutters have
fallen off





Bird nest
in soffits

Current Metal
Flashings
nailed onto
Fascia Boards



Current Metal
Flashings
nailed onto
Fascia Boards





Rotted
fascia
boards







Proposals Needing Approval (2/6)

- Installation of aluminum clad over all newly installed fascia boards
 - **The remaining fascia boards have a poorly installed metal clad on them currently**
 - Wood boards must be maintained and painted over every few years to prevent decay. Properly installed aluminum clad does not require maintenance.
 - We propose the installation of new aluminum clad over all of the new fascia boards to ensure this does not need to be revisited for many years to come.

ROLL FLASHING

ALUMINUM MILL FINISH								
	Economy Code (.009)	Description	Pallet Qty.	Length Feet	Color	Type	Gauge	Weight Lbs.
	RF 8x10 EC MILL	8 x 10 Aluminum Economy Mill	50	10	Bare	Econ	.009	0.76
	RF 8x25 EC MILL	8 x 25 Aluminum Economy Mill	50	25		Econ	.009	1.90
	RF 8x50 EC MILL	8 x 50 Aluminum Economy Mill	50	50		Econ	.009	3.80
	RF 10x10 EC MILL	10 x 10 Aluminum Economy Mill	50	10	Bare	Econ	.009	0.96
	RF 10x25 EC MILL	10 x 25 Aluminum Economy Mill	50	25		Econ	.009	2.40
	RF 10x50 EC MILL	10 x 50 Aluminum Economy Mill	50	50		Econ	.009	4.80
	RF 14x10 EC MILL	14 x 10 Aluminum Economy Mill	50	10	Bare	Econ	.009	1.34
	RF 14x25 EC MILL	14 x 25 Aluminum Economy Mill	50	25		Econ	.009	3.35
	RF 14x50 EC MILL	14 x 50 Aluminum Economy Mill	50	50		Econ	.009	6.70
	RF 20x10 EC MILL	20 x 10 Aluminum Economy Mill	50	10	Bare	Econ	.009	1.90
	RF 20x25 EC MILL	20 x 25 Aluminum Economy Mill	50	25		Econ	.009	4.75
	RF 20x50 EC MILL	20 x 50 Aluminum Economy Mill	50	50		Econ	.009	9.50

ALUMINUM MILL FINISH								
	Standard Code (.011)	Description	Pallet Qty.	Length Feet	Color	Type	Gauge	Weight Lbs.
	RF 8x10 STD MILL	8 x 10 Aluminum Standard Mill	50	10	Bare	Std	.011	1.00
	RF 8x25 STD MILL	8 x 25 Aluminum Standard Mill	50	25		Std	.011	2.50
	RF 8x50 STD MILL	8 x 50 Aluminum Standard Mill	50	50		Std	.011	5.00
	RF 10x10 STD MILL	10 x 10 Aluminum Standard Mill	50	10	Bare	Std	.011	1.24
	RF 10x25 STD MILL	10 x 25 Aluminum Standard Mill	50	25		Std	.011	3.10
	RF 10x50 STD MILL	10 x 50 Aluminum Standard Mill	50	50		Std	.011	6.20
	RF 14x10 STD MILL	14 x 10 Aluminum Standard Mill	50	10	Bare	Std	.011	1.78
	RF 14x25 STD MILL	14 x 25 Aluminum Standard Mill	50	25		Std	.011	4.45
	RF 14x50 STD MILL	14 x 50 Aluminum Standard Mill	50	50		Std	.011	8.90
	RF 20x10 STD MILL	20 x 10 Aluminum Standard Mill	50	10	Bare	Std	.011	2.50
	RF 20x25 STD MILL	20 x 25 Aluminum Standard Mill	50	25		Std	.011	6.25
	RF 20x50 STD MILL	20 x 50 Aluminum Standard Mill	50	50		Std	.011	12.50

Proposed Fascia Color



818 - BRONZE

Finished Look (before gutters)



Finished Look (before gutters)



Finished Look (gutters attach to fascia)



Finished Look (gutters attach to fascia)

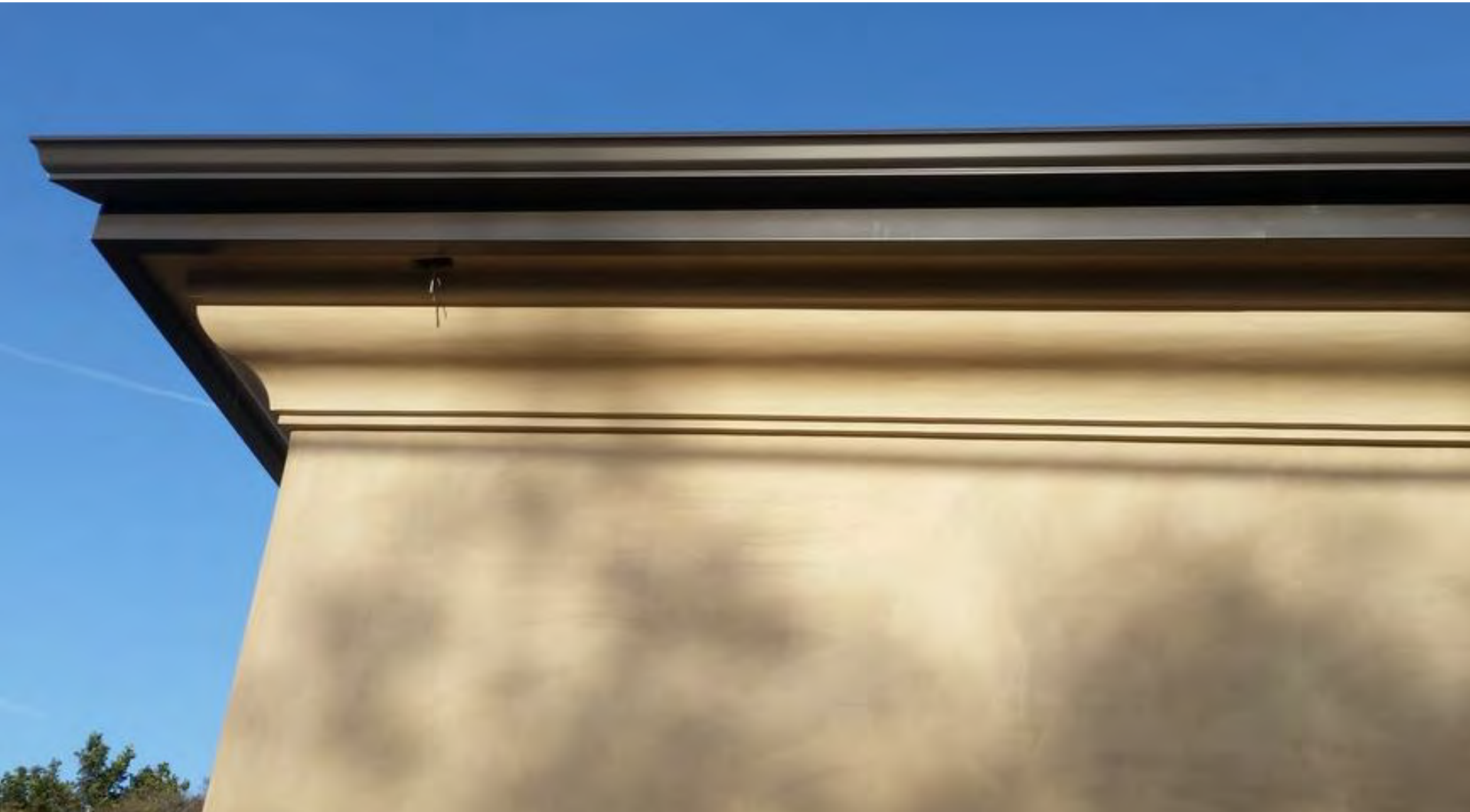

Finished Look (gutters attach to fascia)



Proposals Needing Approval (3/6)

- Removal and replacement of all remaining soffit boards.
 - Existing boards are completely weathered beyond repair, and have been warped due to water leaks, cracked due to the immense weight of the clay roof, and many boards have mold on the back, inside of the attic.
 - Many boards are missing, with multiple holes having formed around the perimeter of the home allowing for birds to enter the attic.
 - New boards will also be installed where existing boards have rotted away entirely and are no longer present.



Soffit boards warped and no longer flat. Need to be completely replaced because wood supporting soffits has rotted out behind the soffits.

Portions of the original metal clad on the fascia that has rusted and is falling off

Soffit boards have warped due to water infiltration



Soffit boards have warped due to water infiltration



Soffit boards have warped due to water infiltration



Soffit boards have warped due to water infiltration

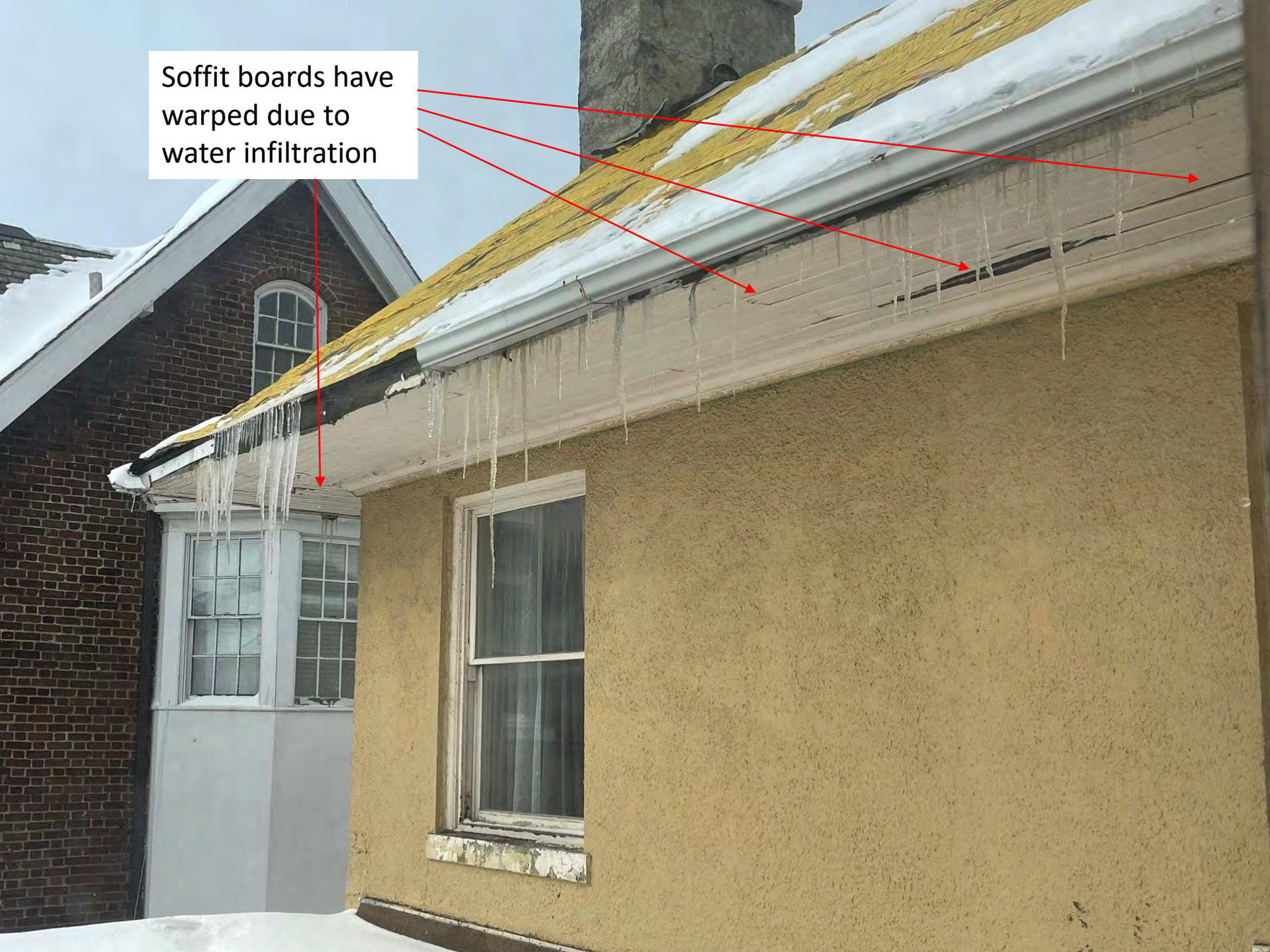

Proposals Needing Approval (4/6)

- Installation of aluminum clad over all newly installed soffit boards.
 - Wood boards must be maintained and painted over every few years to prevent decay.
 - We propose the installation of new aluminum clad over all of the new fascia boards to ensure this does not need to be revisited for many years to come.

V-GROOVE SOFFIT

SVPT4

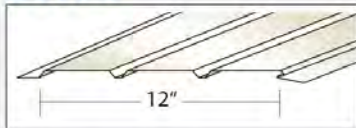

TRIPLE FOUR SOLID V-PANEL

CW01 Colonial White
112 Tuxedo Gray
138 Bone
200 Black
202 Royal Brown
204 Grecian Green
214 Woodland Green
223 Imperial Brown
238 Hickory/336 Clay
250 Musket Brown
280 White
325 Sandstone Beige
327 Desert Tan
355 Light Maple
360 Terratone
422 Pebblestone Clay
713 Wicker
791 Norwegian Wood
792 Heather
793 Sandcastle
801 Almond
805 Pewter/397
817 Cream/326
818 Bronze
819 Herringbone
820 Cranberry
841 Buckskin
901 Ivory

Special colors available • 5 carton min.

CARTON CONTENTS

- 16 Pieces • 12 Ft. Lengths
- To Cover 192 Sq. Ft. • 57 Lbs.

CVPT4

NFA 5.0

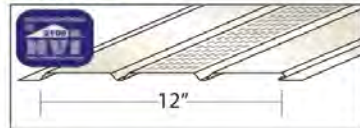

TRIPLE FOUR CENTER VENT V-PANEL

CW01 Colonial White
112 Tuxedo Gray
138 Bone
200 Black
202 Royal Brown
204 Grecian Green
214 Woodland Green
223 Imperial Brown
238 Hickory/336 Clay
250 Musket Brown
280 White
325 Sandstone Beige
327 Desert Tan
355 Light Maple
360 Terratone
422 Pebblestone Clay
713 Wicker
791 Norwegian Wood
792 Heather
793 Sandcastle
801 Almond
805 Pewter/397
817 Cream/326
818 Bronze
819 Herringbone
820 Cranberry
841 Buckskin
901 Ivory

Special colors available • 5 carton min.

CARTON CONTENTS

- 16 Pieces • 12 Ft. Lengths
- To Cover 192 Sq. Ft. • 57 Lbs.

LVPT4

NFA 23.2

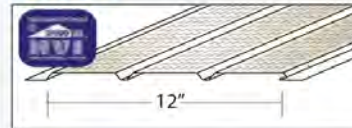

TRIPLE FOUR LANCED V-PANEL

CW01 Colonial White
112 Tuxedo Gray
138 Bone
200 Black
202 Royal Brown
204 Grecian Green
214 Woodland Green
223 Imperial Brown
238 Hickory/336 Clay
250 Musket Brown
280 White
325 Sandstone Beige
327 Desert Tan
355 Light Maple
360 Terratone
422 Pebblestone Clay
713 Wicker
791 Norwegian Wood
792 Heather
793 Sandcastle
801 Almond
805 Pewter/397
817 Cream/326
818 Bronze
819 Herringbone
820 Cranberry
841 Buckskin
901 Ivory

Special colors available • 5 carton min.

CARTON CONTENTS

- 16 Pieces • 12 Ft. Lengths
- To Cover 192 Sq. Ft. • 57 Lbs.

BST4 | BCVT4 | BLT4

BUILDERS GRADE T4 SOFFIT

TRIPLE FOUR V-PANEL SOLID/CENTER VENT/ LANCED

202 Royal Brown
238 Hickory
280 White
713 Wicker
795 Mocha

CARTON CONTENTS

- 16 Pieces • 12 Ft. Lengths
- To Cover 192 Sq. Ft. • 50 Lbs.

SOFFIT ACCESSORIES

WFJ38

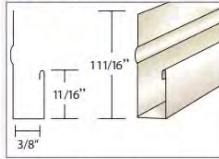

3/8" J CHANNEL MOULDING

- CW01 Colonial White
- 112 Tuxedo Gray
- 138 Bone
- 200 Black
- 202 Royal Brown
- 204 Grecian Green
- 214 Woodland Green
- 223 Imperial Brown
- 238 Hickory
- 250 Musket Brown
- 280 White
- 325 Sandstone Beige
- 327 Desert Tan
- 355 Light Maple
- 360 Terratone
- 422 Pebblestone Clay
- 713 Wicker
- 791 Norwegian Wood
- 792 Heather
- 793 Sandcastle
- 795 Mocha
- 801 Almond
- 805 Pewter
- 817 Cream
- 818 Bronze
- 819 Herringbone
- 820 Cranberry
- 841 Buckskin
- 901 Ivory

CARTON CONTENTS

White: • 50 Pieces • 12 Ft. Lengths
600 Ft. Per Carton • 32 Lbs.

Colors: • 25 Pieces • 12 Ft. Lengths
300 Ft. Per Carton • 17 Lbs.

Use with T4/Q4

WFJ5

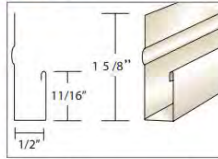

1/2" J CHANNEL MOULDING

- CW01 Colonial White
- 102 Pearl Gray
- 112 Tuxedo Gray
- 138 Bone
- 200 Black
- 202 Royal Brown
- 204 Grecian Green
- 214 Woodland Green
- 223 Imperial Brown
- 238 Hickory
- 250 Musket Brown
- 280 White
- 325 Sandstone Beige
- 327 Desert Tan
- 355 Light Maple
- 360 Terratone
- 713 Wicker
- 791 Norwegian Wood
- 792 Heather
- 793 Sandcastle
- 801 Almond
- 805 Pewter
- 817 Cream
- 818 Bronze
- 819 Herringbone
- 820 Cranberry
- 821 Ivy
- 822 Pacific Blue
- 841 Buckskin
- 901 Ivory

CARTON CONTENTS

White: • 50 Pieces • 12 Ft. Lengths
600 Ft. Per Carton • 35 Lbs.

Colors: • 25 Pieces • 12 Ft. Lengths
300 Ft. Per Carton • 19 Lbs.

Use with D5/D6

J58

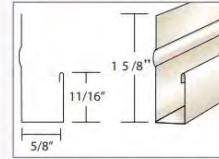

5/8" J CHANNEL MOULDING

Certaineed/Wolverine Colors

- CW01 Colonial White
- 102 Pearl Gray
- 202 Royal Brown
- 223 Imperial Brown
- 224 Woodstock Tan
- 238 Hickory
- 250 Musket Brown
- 280 White
- 325 Sandstone Beige
- 327 Desert Tan
- 335 Barn Red
- 355 Light Maple
- 713 Wicker
- 791 Norwegian Wood
- 793 Sandcastle
- 801 Almond
- 805 Pewter
- 817 Cream
- 819 Herringbone
- 841 Buckskin
- 901 Ivory

CARTON CONTENTS

• 25 Pieces • 12 Ft. Lengths
• 300 Ft. Per Carton • 19 Lbs.

Use with Aluminum Siding/Vinyl Soffit

XWJ

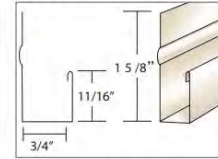

3/4" J CHANNEL MOULDING

- CW01 Colonial White
- 202 Royal Brown
- 214 Woodland Green
- 238 Hickory
- 250 Musket Brown
- 280 White
- 325 Sandstone Beige
- 327 Desert Tan
- 355 Light Maple
- 360 Terratone
- 713 Wicker
- 791 Norwegian Wood
- 801 Almond
- 805 Pewter
- 817 Cream
- 819 Herringbone
- 841 Buckskin
- 901 Ivory

CARTON CONTENTS

• 25 Pieces • 12 Ft. Lengths
• 300 Ft. Per Carton • 23 Lbs.

SR58

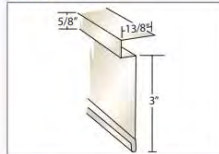

5/8" SOFFIT RECEIVER

- 230 Beige
- 238 Hickory
- 280 White

CARTON CONTENTS

• 20 Pieces • 10 Ft. Lengths
• 200 Ft. Per Carton
• 25 Lbs.

VSR1

NFA 4.2

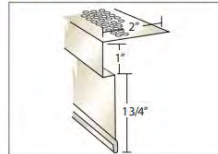

SOFFIT RECEIVER

Per Square Inch/Per Lin Ft.

- 230 Beige
- 238 Hickory
- 280 White

CARTON CONTENTS

• 20 Pieces • 10 Ft. Lengths
• 200 Ft. Per Carton
• 20 Lbs.

VSR92

NFA 9.2

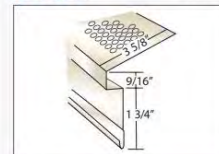

SOFFIT RECEIVER

Per Square Inch/Per Lin Ft.

- 230 Beige
- 238 Hickory
- 280 White

CARTON CONTENTS

• 20 Pieces • 10 Ft. Lengths
• 200 Ft. Per Carton
• 20 Lbs.

SOFFIT ACCESSORIES

FR38

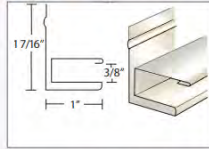

3/8" FRIEZE RUNNER

CW01 Colonial White
 112 Tuxedo Gray
 138 Bone
 200 Black
 202 Royal Brown
 204 Grecian Green
 214 Woodland Green
 223 Imperial Brown
 238 Hickory
 250 Musket Brown
 280 White
 325 Sandstone Beige
 327 Desert Tan
 355 Light Maple
 360 Terratone
 422 Pebblestone Clay
 713 Wicker
 791 Norwegian Wood
 792 Heather
 793 Sandcastle
 795 Mocha
 801 Almond
 805 Pewter
 817 Cream
 818 Bronze
 819 Herringbone
 820 Cranberry
 841 Buckskin
 901 Ivory

CARTON CONTENTS
 • 25 Pieces • 12 Ft. Lengths
 • 300 Ft. Per Carton • 35 Lbs.
Use with T4 & Q4 Soffit

DCR19

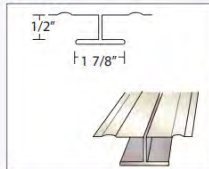

DOUBLE CHANNEL RUNNER
 238 Hickory
 280 White
 713 Wicker

*Special colors available • 3 carton min.
 Custom Bent Only*

CARTON CONTENTS
 • 10 Pieces • 10 Ft. Lengths
 • 100 Ft. Per Carton • 17 Lbs.

FR119

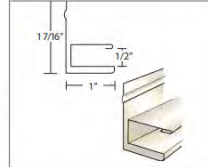

1/2" FRIEZE RUNNER

CW01 Colonial White
 102 Pearl Gray
 112 Tuxedo Gray
 200 Black
 202 Royal Brown
 204 Grecian Green
 223 Imperial Brown
 238 Hickory
 250 Musket Brown
 280 White
 325 Sandstone Beige
 360 Terratone
 713 Wicker
 801 Almond
 818 Bronze
 819 Herringbone
 820 Cranberry
 821 Ivy
 822 Pacific Blue
 841 Buckskin

CARTON CONTENTS
 • 25 Pieces • 12 Ft. Lengths
 • 300 Ft. Per Carton • 35 Lbs.

Use with D5 & D6 Soffit

FANDJ

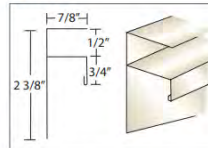

COMBINATION CHANNEL

112 Tuxedo Gray
 202 Royal Brown
 214 Woodland Green
 238 Hickory
 280 White

*Special colors available • 3 carton min.
 Custom Bent Only*

CARTON CONTENTS
 • 20 Pieces • 10 Ft. Lengths
 • 200 Ft. Per Carton • 24 Lbs.

FR58

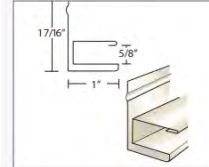

5/8" FRIEZE RUNNER

CW01 Colonial White
 202 Royal Brown
 238 Hickory
 250 Musket Brown
 280 White
 360 Terratone
 713 Wicker
 791 Norwegian Wood

CARTON CONTENTS
 • 25 Pieces • 10 Ft. Lengths
 • 250 Ft. Per Carton • 35 Lbs.

Use with Vinyl Soffit

RCM19

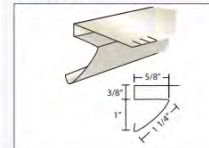

CROWN MOULDING

202 Royal Brown
 214 Woodland Green
 238 Hickory
 250 Musket Brown
 280 White
 713 Wicker
 791 Norwegian Wood
 793 Sandcastle
 801 Almond
 805 Pewter/St. Gray
 819 Herringbone

CARTON CONTENTS
 • 25 Pieces • 12 Ft. Lengths
 • 300 Ft. Per Carton • 27 Lbs.

FR34

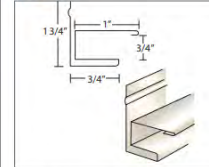

3/4" FRIEZE RUNNER

CW01 Colonial White
 238 Hickory
 280 White
 713 Wicker

Custom Bent Only

CARTON CONTENTS
 • 25 Pieces • 10 Ft. Lengths
 • 250 Ft. Per Carton • 35 Lbs.

Soffit Panel Dimensions

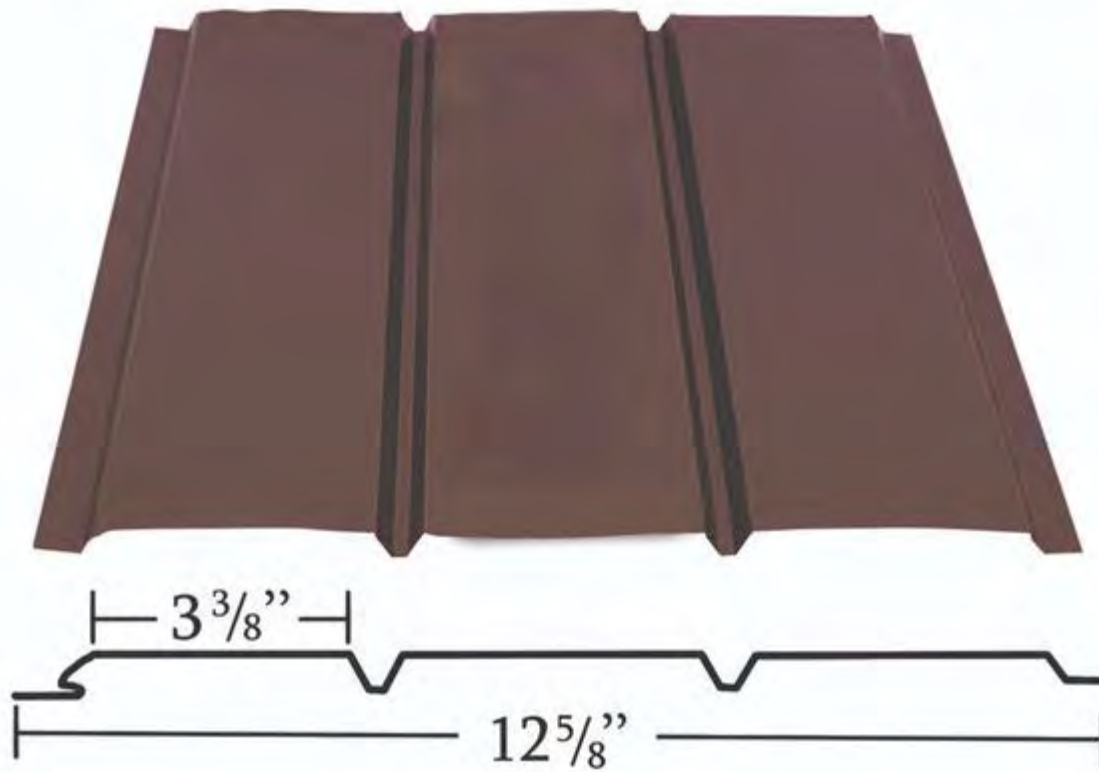

Finished Look



Finished Look



Proposals Needing Approval (5/6)

- Installation of new metal roofing system
 - Proposed Product: GrandeTile manufactured by Classic Metal Metal Roofing Systems (subsidiary of Isaiah Industries)
 - THIS EXACT PRODUCT WAS RECOMMENDED BY STAFF ON 2-18-2021 VIA EMAIL, AND ALSO LISTED IN THE HDC STAFF REPORT ON 3-9-2021 AS A RECOMMENDED PRODUCT TO USE.
 - Upon review of the current application, staff did reach out to the applicant/homeowner to express their concern that the proposed new metal roofing product did not adequately replicate the barrel clay tile that was removed without approval because it replicates a wood shake. Staff did recommend that the applicant explore the following option, which more closely resembles the Spanish / barrel style tile: <https://www.americanmetalroofs.com/products/terra-tile/>

GrandeTile Features

Measurements

Single course panels have an exposure height of 13.75”.

Double course panels have an exposure height of 27.75”.

Panels can be cut to length, and the maximum panel length is 19’.

Weight

GrandeTile Weight: 67 lbs./square

- Total Approximate weight: 1675 lbs. (0.75 metric tons)

Average Clay Roof Weight: 700-1500 lbs./square

- Total Approximate weight 17,500 to 37,500 lbs. (8 to 17 metric tons)

Strength

All panels, including, pre-formed accessories and flashings and matching coil stock are made of .032” 3105 H24 aluminum alloy sheet stock with a yield strength of 26,400 psi. and tensile strength on 27,700 psi.

Finish

Grande Tile panels are coated with a baked-on protective primer and a Kynar 500® or Hylar 5000® PVDF topcoat to provide a high-quality finish. Kynar 500® and Hylar 5000® PVDF resin-based finishes are trade names for polyvinylidene fluoride resin. The backs of the panels are finished with a protective clear coat.

Additional Materials

Other materials available from the manufacturer include color matching high-temperature silicone sealant, underlayment, touch-up paint, pipe flashings, and stainless steel screws all made to blend with the roofing tiles.

Revision	Description	Date
----------	-------------	------

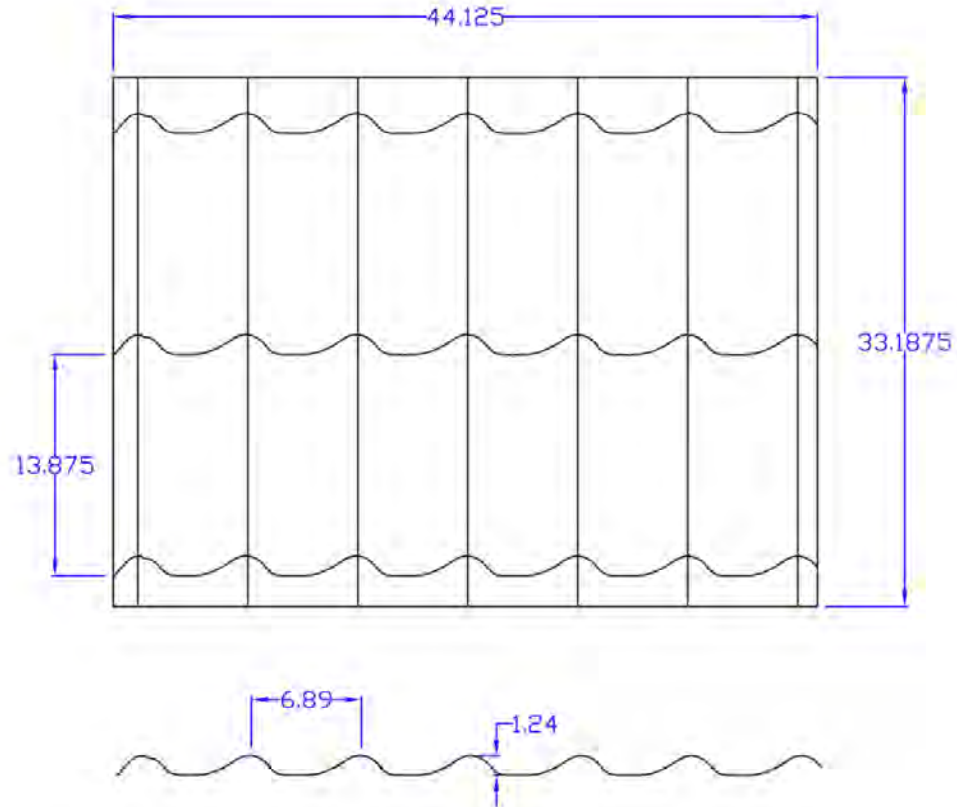

Exposure	41.375' x various
Metal	3105 H24 ASTM B209 aluminum alloy
Thickness	.032"
Strip width	48"

Drawn By: Eric Voress	Isaiah Industries, Inc.
Date: 10/10/2013	Part Name: Grande Tile Panel
Scale: 1:10	Part Number: L-601

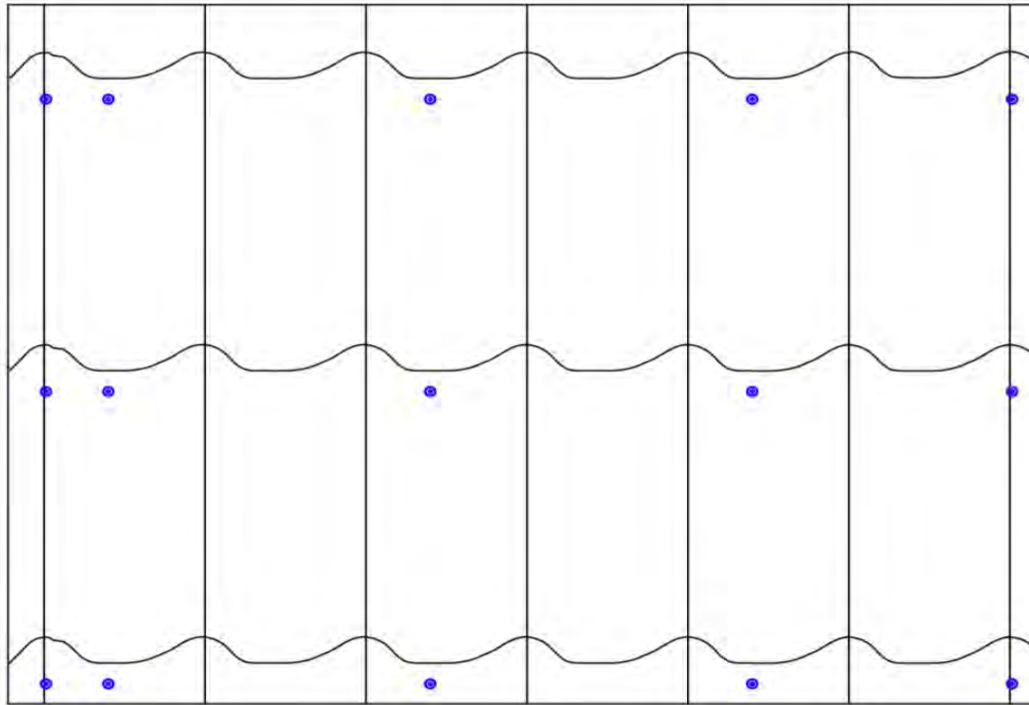

2.5" stainless steel screw
w/bonded seal washer at
the vertical laps.

1.5" stainless steel
screw w/bonded
seal washer.

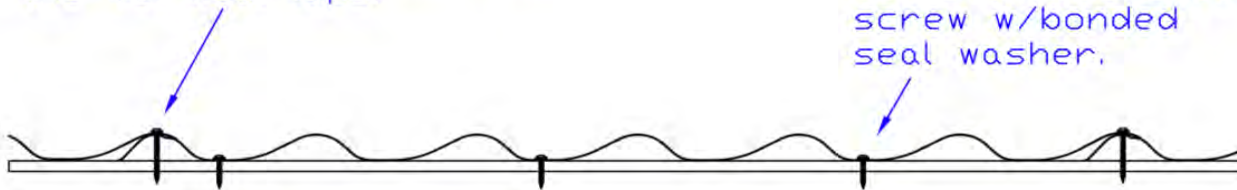

Standard and Miami-Dade field
condition attachment pattern.

Fasteners on every course.

Eave Detail

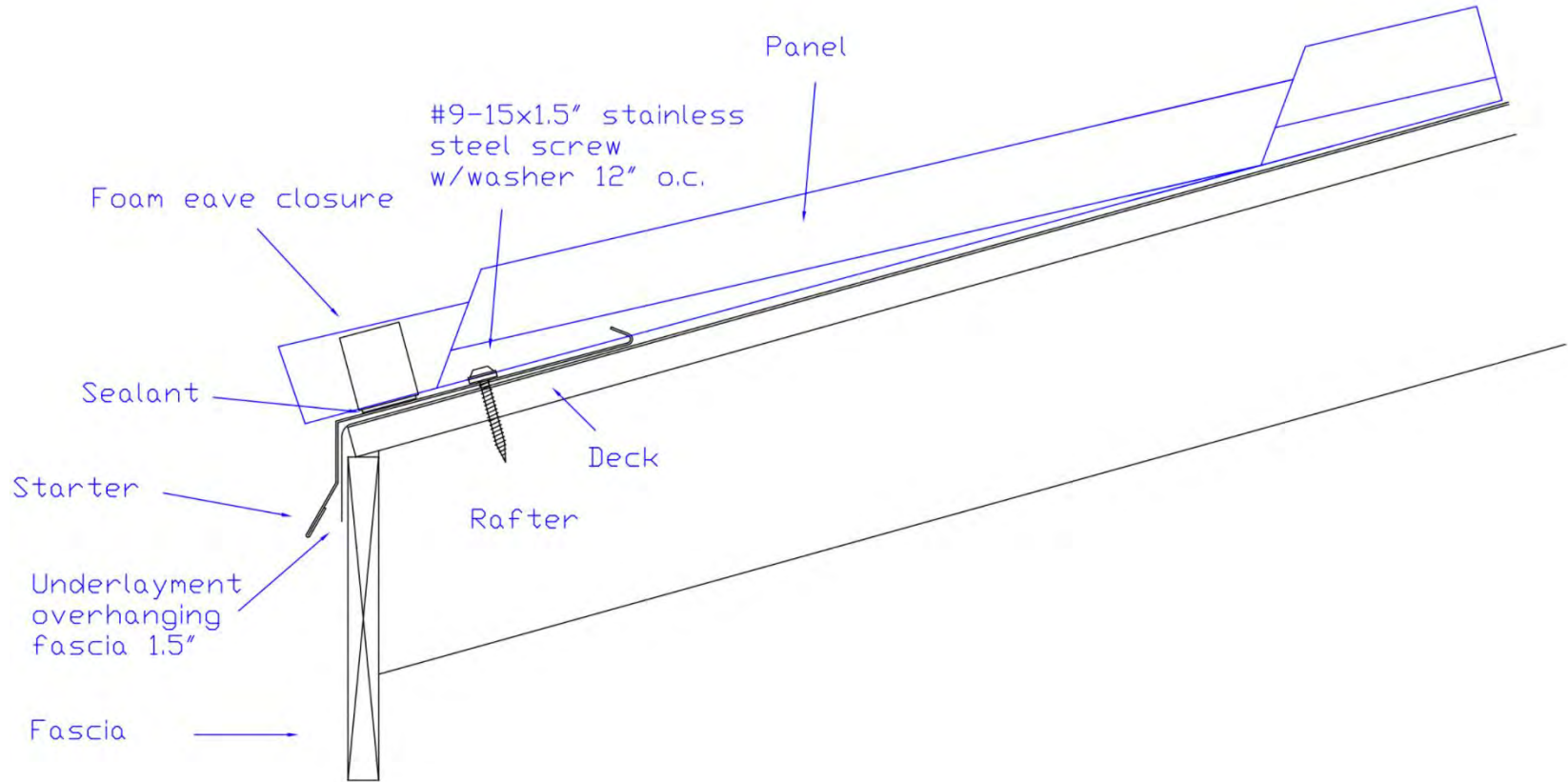

Gable Detail

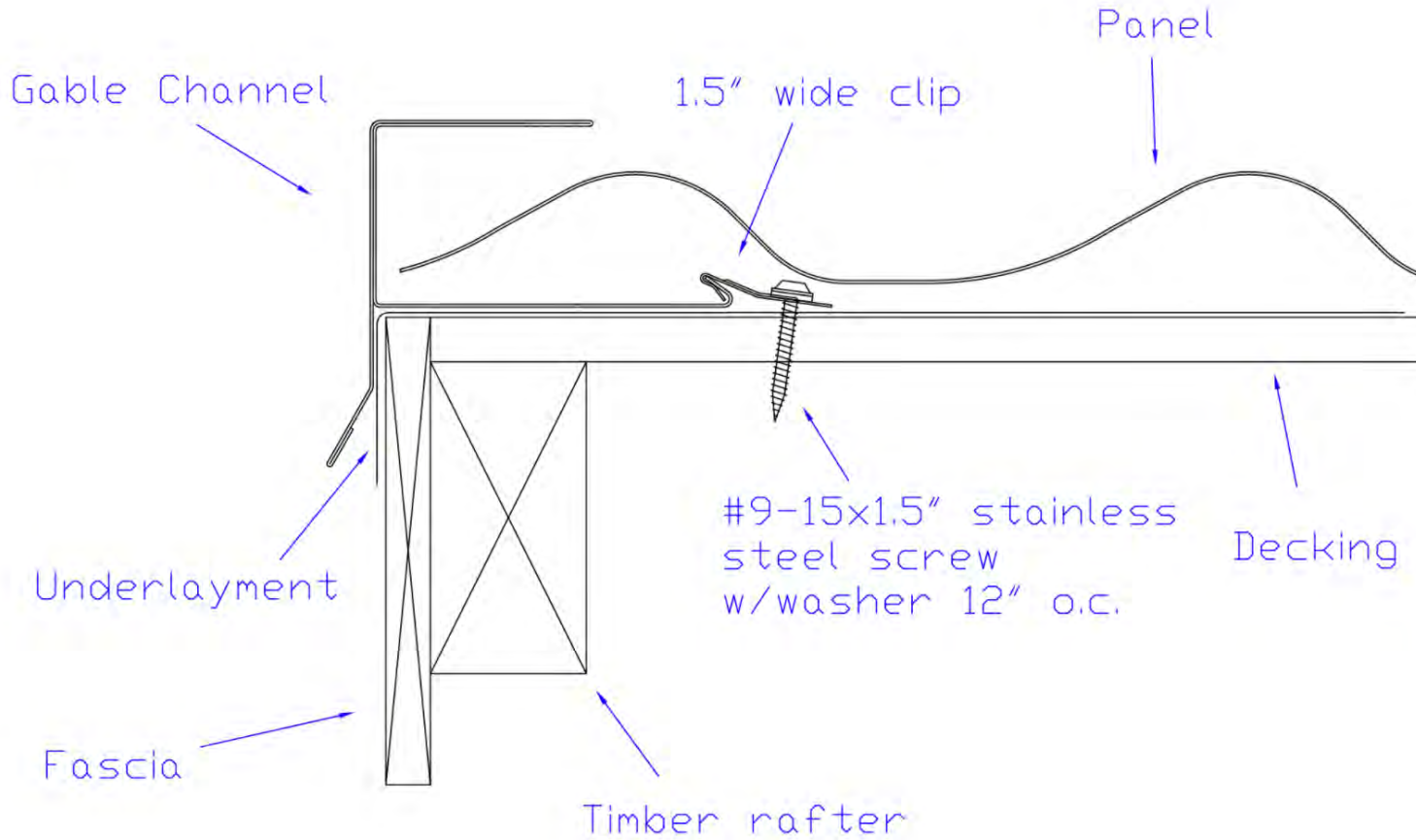

Hip Detail

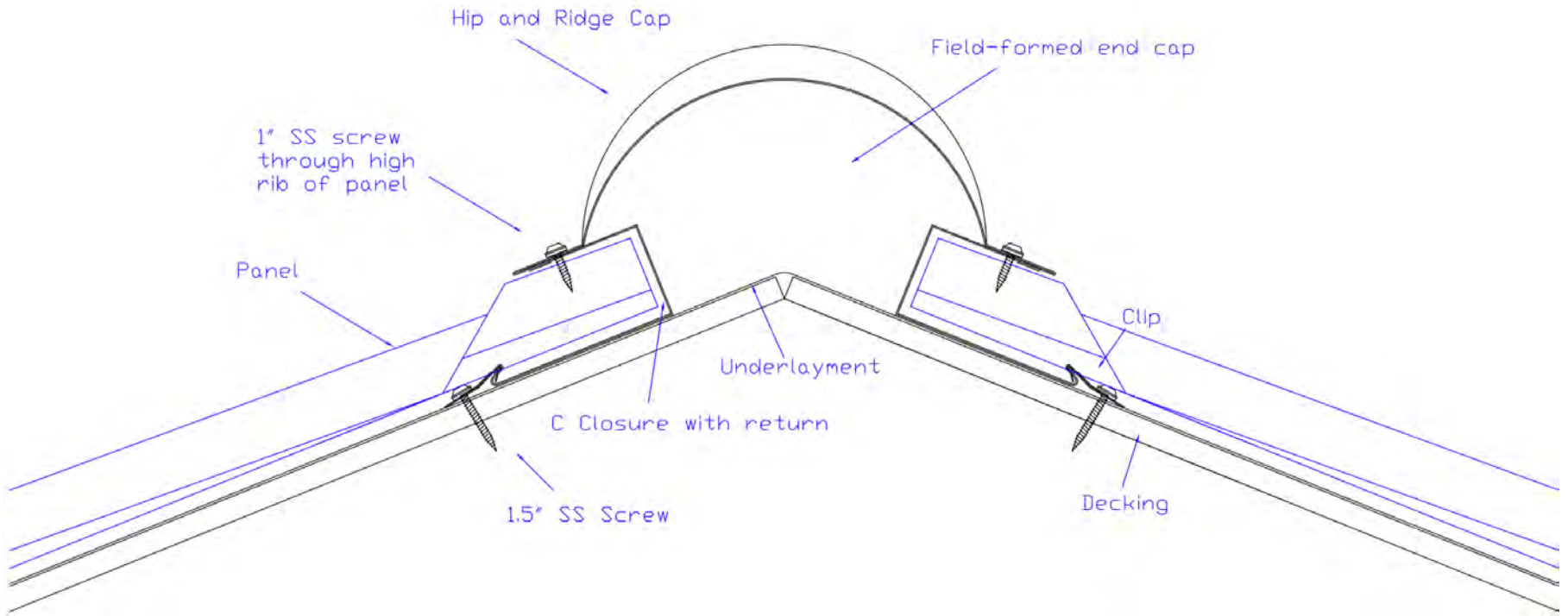

Ridge Detail

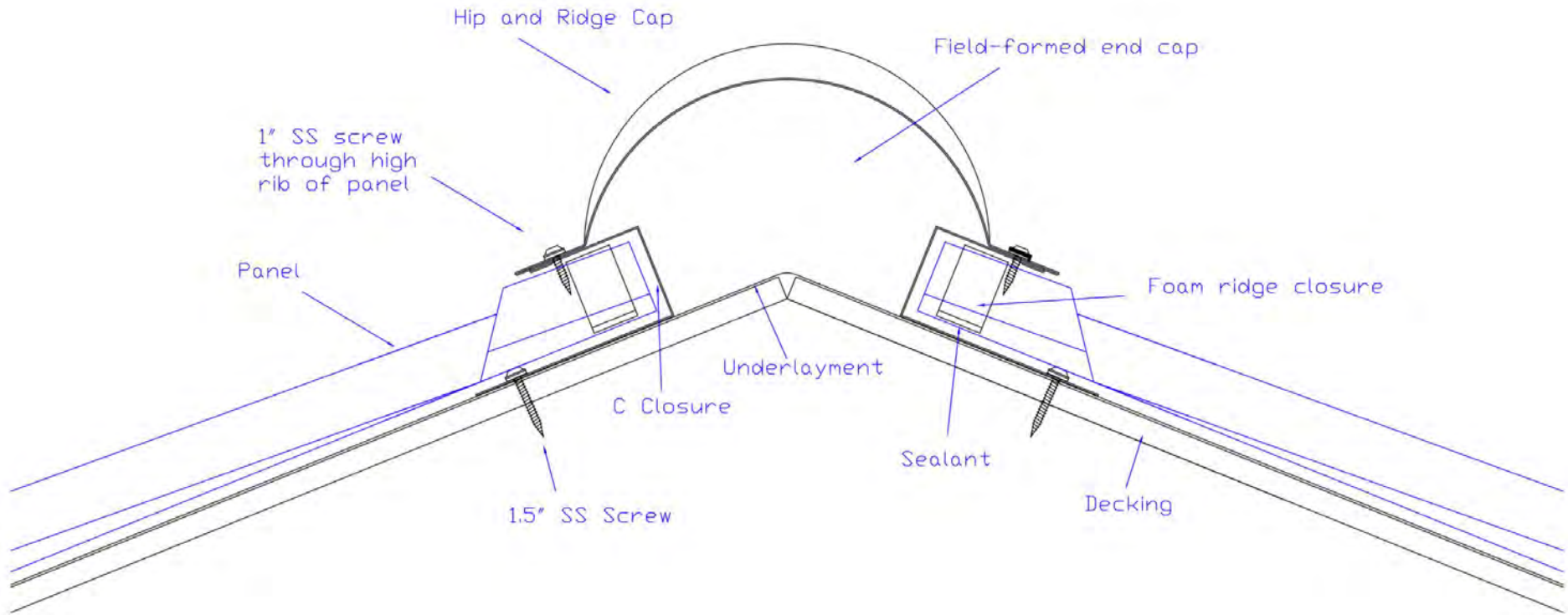

Revision:	Description:	Date:
-----------	--------------	-------

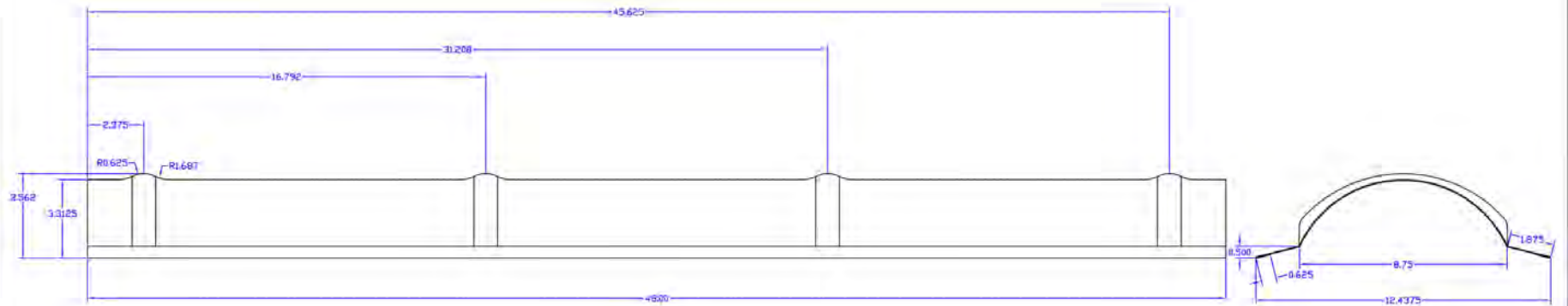

Material:	3105 H24 ASTM B209 aluminum alloy
Metal thickness:	.032"
Strip width:	15"
Tolerance:	All dimensions +/- .032"

Drawn By: Eric Voress	Isiah Industries, Inc.
Date: 1/24/2017	Part Name: Hip ridge cap
Scale: 1:4	Part Number: 507

The black lines are the outline of the installed ridge cap and accessories.
The blue lines show extra metal to be folded back 90 degrees into the assembly.
The red lines are cut lines.

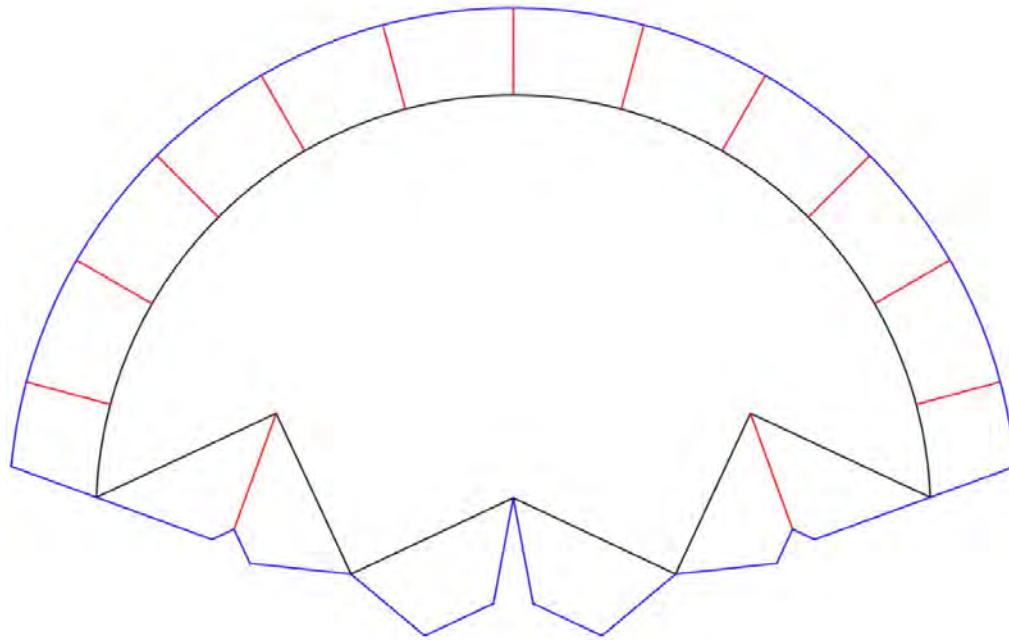

Valley Detail

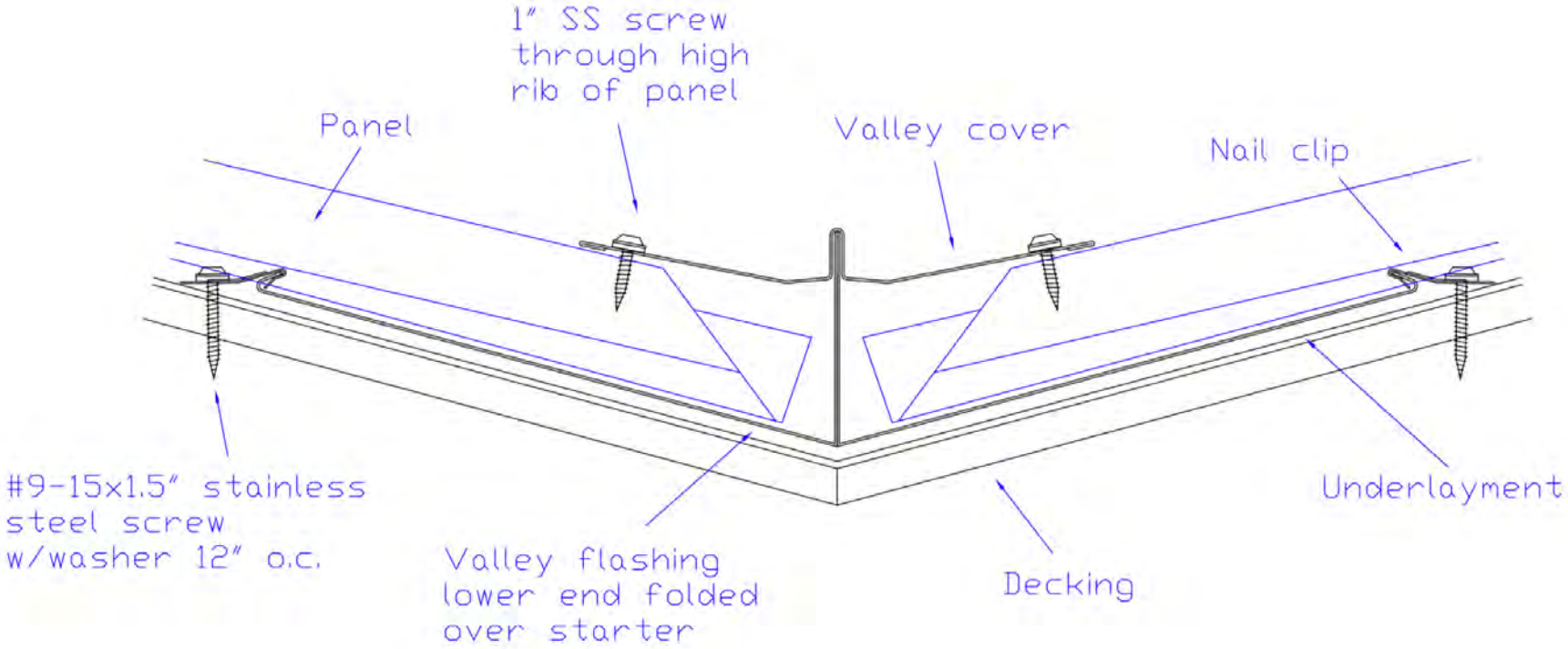

Sidewall Detail

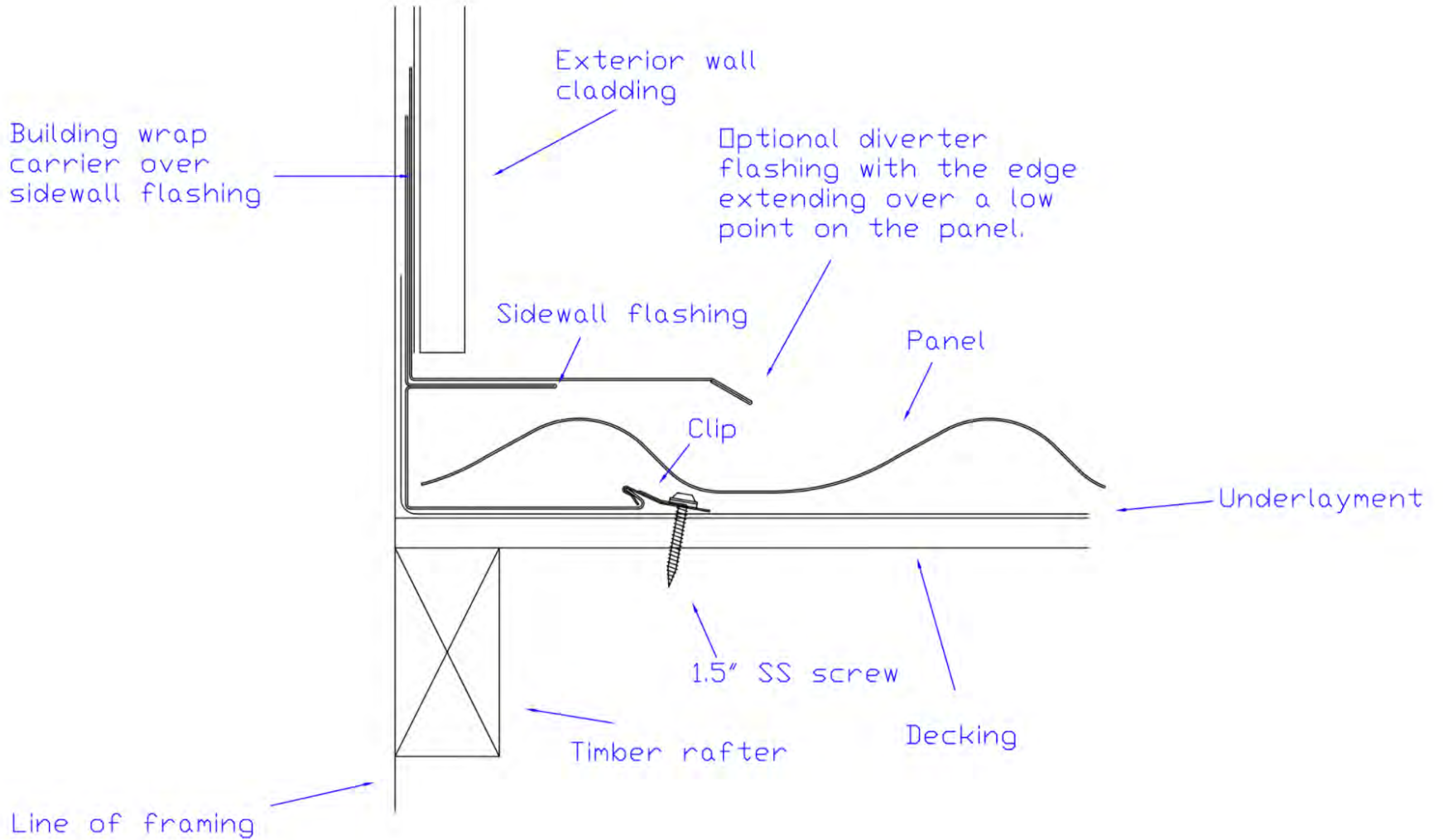

Headwall Detail

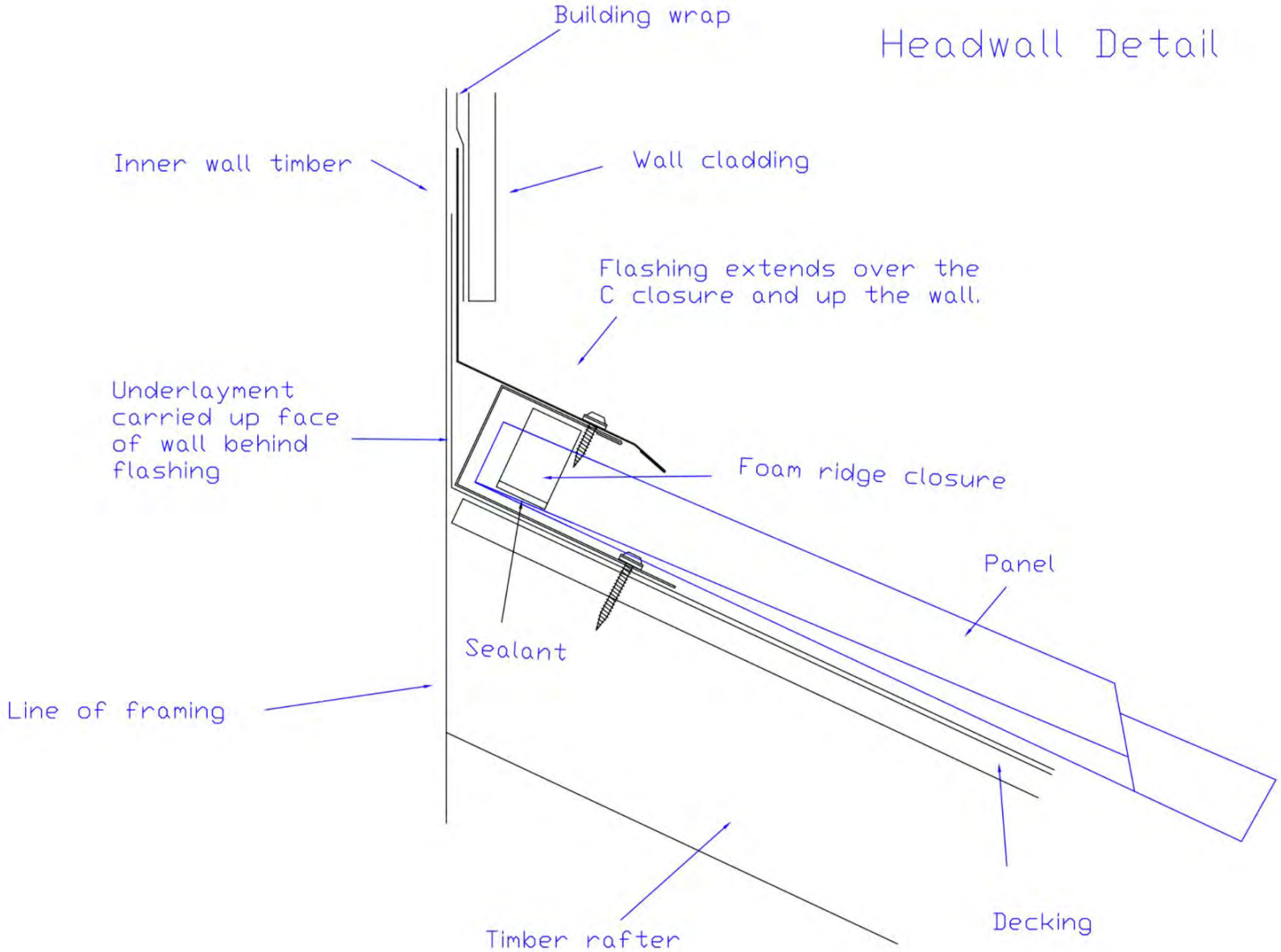

Vent Pipe Detail

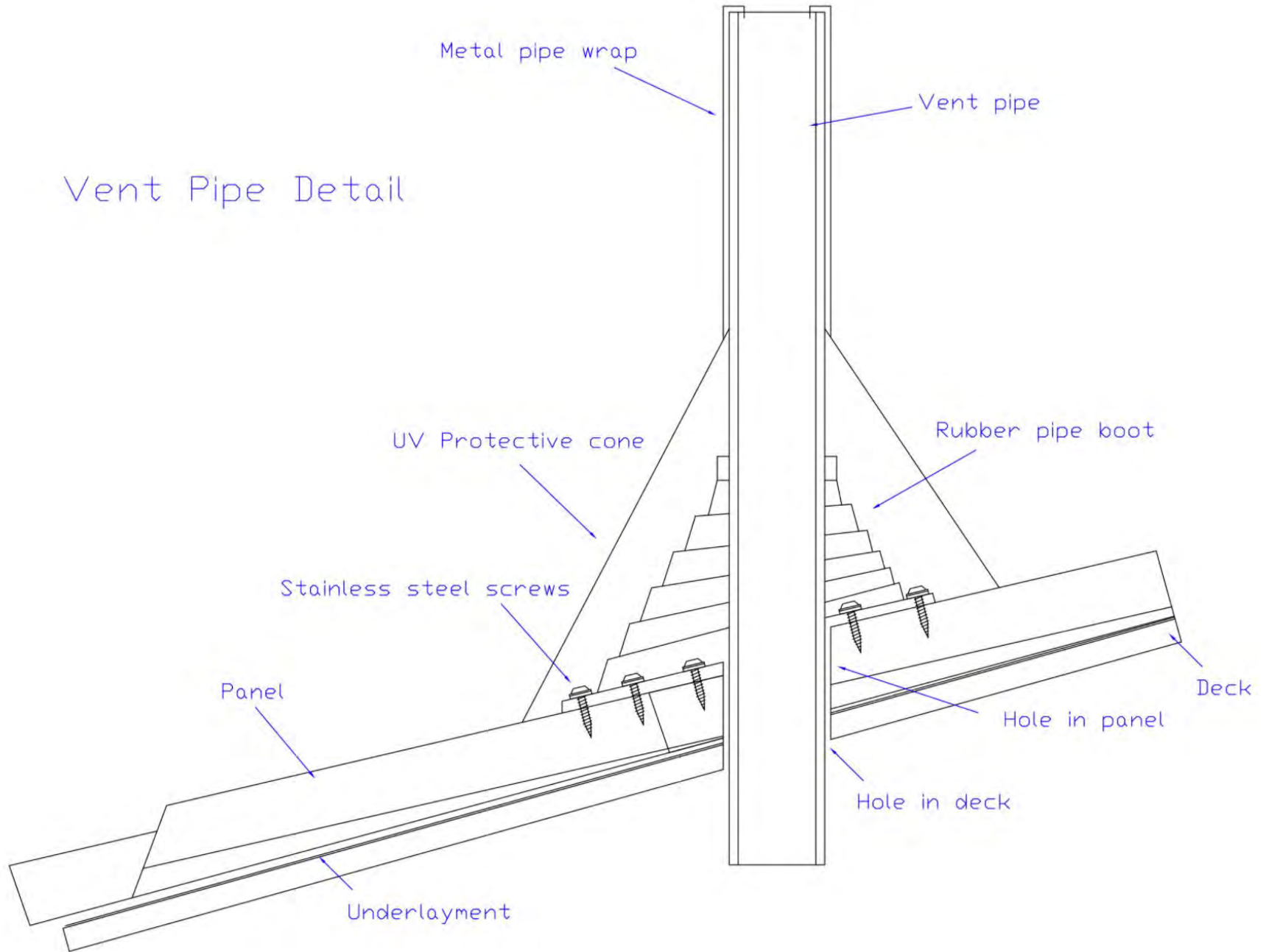

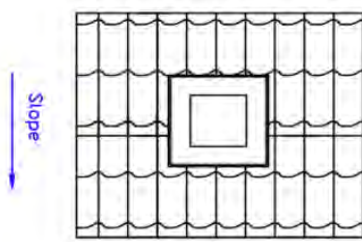

Install panels around the chimney

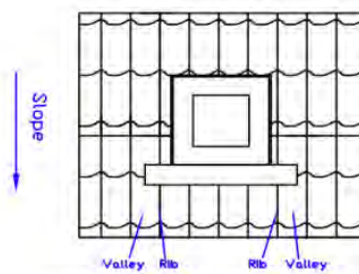

The top of the front flashing should extend up the front of the chimney and out over the top of the panels. The sides of the front flashing should extend over a rib and to the center of a valley in the panel.

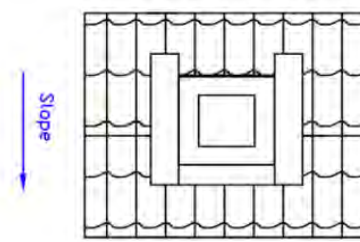

The side flashings should extend over the front flashing and up the sides of the chimney.

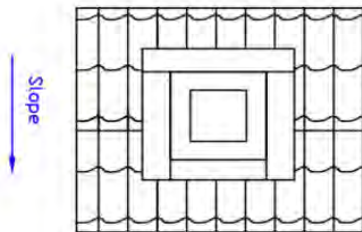

The back flashing should extend up the chimney, over the side flashings, and over the panels. Some of the high spots in the panel may need to be removed to allow the flashing to rest as flat as possible.

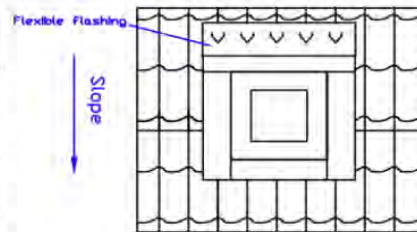

Install flexible flashing over the back flashing and over the ribs on the panel.

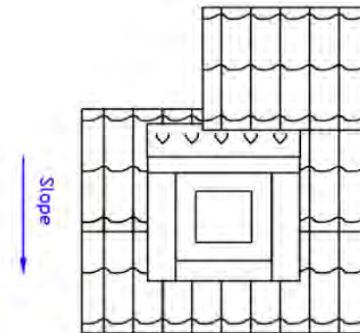

Install the next course of panels over the flexible flashing.

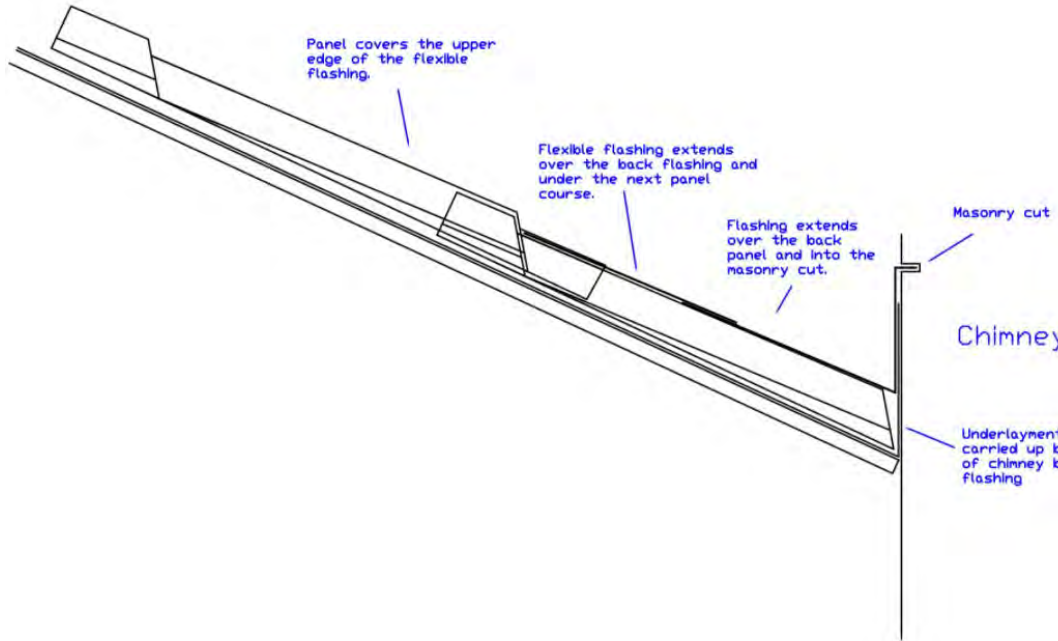

Chimney side view

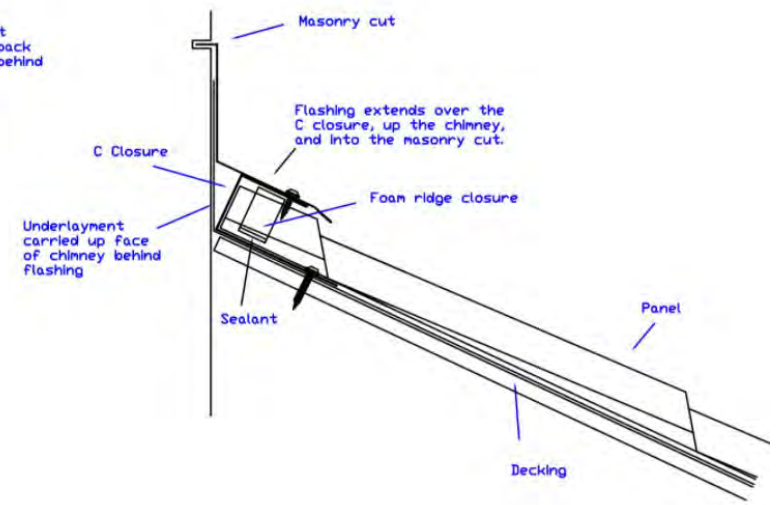

GrandeTile Installation

Pitch

Grande Tile panels are designed for installations on roofs with a 3:12 or greater pitch.

Decking

The panels are applied over minimum 1/2" decking. The system may also be applied over existing composition roofing provided the existing roofing is smooth. Any curled or irregular roofing must be removed or replaced.

Underlayment

In the case of either a new roofing application or re-roofing, the entire roof must be covered with at least one layer of 30 pound felt underlayment or equivalent.

Panels

Grande Tile panels install right to left, and lap, top over bottom and side overside.

Anchorage

Grande Tile panels are held in place with to the deck with #9-15 stainless steel screws with stainless steel bonded seal washers. The screws should be of sufficient length to fully penetrate the decking.

GrandeTile Warranty

- Lifetime warranty on GrandeTile panels is provided by Isaiah Industries Inc
- Lifetime warranty on all labor and installation provided by Alexandria Windows, Doors, Metal Roofing LLC.
- Use of synthetic ice and water underlayment on the entire roof deck are required for lifetime labor and installation warranty. Panel warranty is included regardless of underlayment type.

Lifetime / 40-Year Transferable Limited Warranty

GrandeTile aluminum roofing and accessories (the "Products") are manufactured by Classic Metal Roofing Systems in accordance with high standards of engineering skills, and are quality controlled through every stage of production.

This warranty remains in effect for as long as the owner(s) continues to live and own the property. In the event that there is more than one original property owner, this lifetime limited warranty (this "Warranty") will remain in effect as long as one of the original property owners is living and owns an interest in the property to which the Products were applied. This Warranty is transferable by the original property owner(s) to subsequent owner(s) of the property. In the event of transfer of this Warranty, the warranty period extends 40 years from the Products' installation.

If at the time the Products are applied to the property, the property is owned by an organization (e.g., a corporation, unincorporated association, church, government or public entity) the warranty period extends 40 years from the Products' installation.

Warranty Coverage

Subject to the exclusions and limitations set forth in this Warranty, Classic Metal Roofing Systems warrants that the Products, including the Kynar 500® or Hylar 5000® finish that has been applied in the course of manufacturing, are free from defects in material and workmanship. Specifically, Classic Metal Roofing Systems warrants that the Products will not leak due to hail perforation, burn or support combustion, rust, split, crack, or lose impact resistance with age. The finish on the Products will not chip, peel, flake, or blister under conditions of ordinary wear. The Products will not fade or change color in excess of five (5) Hunter E Units as measured using the procedure of ASTM D-2244-79 (comparing an unexposed panel to the exposed panel after removal of dirt and chalk) for a period of thirty (30) years after installation. The Products will not chalk in excess of ASTM D-659-80 rating eight (8) for a period of thirty (30) years after installation. With proper installation, the Products will not detach from the property or become deformed due to wind velocities up to 120 miles per hour. In the event of any breach of the above Warranty and subject to the exclusions and limitations set forth below, Classic Metal Roofing Systems, upon notification and validation of the complaint, will, solely at its option, either repair, replace, or refinish (providing both materials and labor) the Products found to be defective, without charge to the Original Property Owner(s), or refund the purchase price of the originally installed Products found to be defective (including both materials and labor). Classic Metal Roofing Systems' obligations under this Warranty will, in no event, exceed the purchase price of the originally installed Products found to be defective (including both materials and associated labor). Any costs and expenses beyond Classic Metal Roofing Systems' liability hereunder are the responsibility of the Original Property Owner(s).

In the event of repair, replacement, or refinishing pursuant to this Warranty, the Warranty applicable to the replacement material or to the repaired or refinished Products will extend only for the time remaining under the original Warranty. Due to normal weathering (defined below), Products repaired, replaced, or refinished during the Warranty period may differ in gloss and color from Products that were originally installed, if any such Products remain on the property.

Coverage Exclusions and Limitations

1. This Warranty does not cover damage of any kind resulting from faulty or improper installation; accidental damage; settlement; structural shrinkage or distortion of the structure; hail (except in the case of leakage due to perforation of the Products, which is covered by this Warranty); fire; lightning; hurricane, tornado, or windstorm (in excess of 120mph); vandalism; earthquake or other acts of God; exposure to harmful chemicals; fumes or vapors; misuse; abuse; dirt or mildew accumulation; damage from cascading ice and snow; impact of foreign objects; or other causes beyond the control of Classic Metal Roofing Systems. **THIS WARRANTY WILL NOT APPLY TO PRODUCTS THAT HAVE BEEN PAINTED OR WHOSE SURFACE HAS BEEN ALTERED IN ANY WAY WITHOUT WRITTEN AUTHORIZATION FROM CLASSIC METAL ROOFING SYSTEMS.**

2. Classic Metal Roofing Systems reserves the right to discontinue or change the Products' design and color. If, for any reason, Products of the type originally installed are no longer available from Classic Metal Roofing Systems at the time a Warranty claim is made, and if the Warranty period is still in effect, Classic Metal Roofing Systems, in fulfillment of its Warranty obligations hereunder, has the right to substitute another product determined by Classic Metal Roofing Systems in its sole discretion to be of comparable quality and price.

3. Classic Metal Roofing Systems is giving you an express limited lifetime warranty under the provisions of the Magnuson-Moss Federal Warranty Act; Classic

Metal Roofing Systems cannot and will not be liable to you for a breach of any written or oral express warranties, such as those, if any, given to you by dealers, contractors, applicators, or distributors of the Products.

ANY IMPLIED WARRANTIES IMPOSED BY LAW, SUCH AS THE IMPLIED WARRANTIES OF MERCHANTABILITY AND FITNESS FOR A PARTICULAR PURPOSE ARE LIMITED IN TIME TO THE DURATION OF THIS EXPRESS WARRANTY. CLASSIC METAL ROOFING SYSTEMS WILL NOT BE LIABLE FOR ANY CONSEQUENTIAL OR INCIDENTAL DAMAGES FOR BREACH OF ANY EXPRESS, WRITTEN, ORAL, OR IMPLIED WARRANTY ON THE PRODUCTS. YOUR EXCLUSIVE REMEDY IS SET FORTH IN THIS WARRANTY. SOME STATES DO NOT ALLOW THE EXCLUSION OR LIMITATION OF INCIDENTAL OR CONSEQUENTIAL DAMAGES, AND SOME STATES DO NOT ALLOW LIMITATIONS ON HOW LONG AN IMPLIED WARRANTY LASTS, SO THE ABOVE LIMITATION OR EXCLUSION MAY NOT APPLY TO YOU.

This Warranty gives you specific legal rights. You might also have other rights, which vary from state to state. This Warranty covers only GrandeTile aluminum roofing and accessories. Classic Metal Roofing Systems reserves the right to withdraw or modify this Warranty without notice at any time; however, all warranties registered at the time of the Products' installation remain in effect as written until their expiration.

Warranty Registration

This Warranty is valid only after the warranty registration is completed within 30 days after the installation has been completed. Failure to so notify Classic Metal Roofing Systems of the registration relieves Classic Metal Roofing Systems of all obligations hereunder.

Warranty Transfer

This Warranty may be transferred by the Original Property Owner(s) to a subsequent owner(s) of the property as a 40-Year Non-Prorated Warranty from the date of installation. Upon any transfer of the property and this Warranty, the obligations of the Original Property Owner(s) hereunder become the obligations of the new owner(s). Written notice of transfer of the property should be given to Classic Metal Roofing Systems within 30 days after the date of transfer of ownership of the property. Such notice should include a copy of this Warranty, the address of the property being transferred, the name and mailing address (if different) of the new owner(s) and the date of transfer. Such notice should be sent to Classic Metal Roofing Systems, PO Box 701, Piqua, OH 45356. Failure to so notify Classic Metal Roofing Systems of the transfer relieves Classic Metal Roofing Systems of all obligations herein.

Claims Procedure

Any claim for breach of Warranty hereunder must be presented in writing to Classic Metal Roofing Systems within the Warranty period and within a reasonable period of time after a defect is discovered. The claim should include the following four items: 1) a description of the claimed defect and the date the defect was discovered; 2) a copy of the original contract for the job, including purchase price; 3) a copy of this Warranty and the Products' date of installation; and 4) the owner's name, address, and phone number. Write to Classic Metal Roofing Systems, PO Box 701, Piqua, OH 45356. Classic Metal Roofing Systems will provide notification of specific information and physical evidence required to process your claim. ANY REPAIR OF THE PRODUCTS UNDERTAKEN WITHOUT PRIOR WRITTEN AUTHORIZATION FROM CLASSIC METAL ROOFING SYSTEMS WILL VOID THIS WARRANTY.

Date of Installation: _____ / _____ / _____
MONTH DAY YEAR

Register or transfer your roof Warranty online at
www.classicroof.com/warranty/

At Classic Metal Roofing Systems, we know that today's homeowners want to make their homes reflect their personal sense of style. They are also thinking about the long-term for their homes, looking for building materials that will last, add value, and save energy. GrandeTile does all of these things.

DURABLE

Manufactured from industrial-grade .032" aluminum alloy, GrandeTile offers wind and weather resistance unmatched by other products. Unlike tile roofing, which is prone to cracking and chipping, GrandeTile resists the rigors of aging and stays corrosion-resistant. Even cut edges will not rust. And, the baked-on coating resists fade and degradation better than any other coating available today.

LOW WEIGHT

Tile roofs can weigh up to 2000 pounds per 100 square feet. Even "low weight" tiles far exceed 500 pounds. Fiberglass shingles weigh from 275 to 450 pounds. This weight places strain on your home, and poses significant cave-in threat in the event of an interior fire. GrandeTile weighs under 75 pounds per square.

ENERGY EFFICIENT

GrandeTile's Kynar 500® or Hylar 5000® paint finish includes reflective pigments for energy efficiency. Our proprietary hI-R® coating reflects radiant heat, keeping buildings naturally cooler. Homeowners report energy savings of up to 20% and more, thanks to reduced air conditioning loads. GrandeTile's unique design also includes an integral air gap as a thermal break, further helping to prevent warm weather heat transfer into your home and attic.



CLASSIC
METAL ROOFING SYSTEMS

The World's Most Beautiful Metal Roofs

A Division of Isaiah Industries, Inc.

8510 Industry Park Drive | Piqua, OH 45356

Phone: 800-543-8938 | Fax: 937-778-5116

www.classicroof.com | info@classicroof.com

GRANDETILE



THE GRANDEUR OF TILE WITHOUT THE WEIGHT

A ROOF OF TIMELESS DISTINCTION

FEW ROOFS EVOKE SUCH EMOTION AS BARREL TILE ROOFS. WHETHER THE SETTING IS HISTORIC, CONTEMPORARY, OR ANCIENT – MEDITERRANEAN, TROPICAL, DESERT, OR EVEN SAVANNAH, TILE ROOFS PROVIDE DISTINCTION TO HIGHLIGHT BUILDINGS AND PROVIDE MEMORABLE CHARM. GRANDE TILE PROVIDES THIS LOOK ALONG WITH THE PROVEN AND POPULAR BENEFITS OF METAL ROOFING.



PANEL SIZES

GrandeTile is available in one and two-course modular or full-length panels, custom-crafted to meet the rafter lengths of your roof.



GrandeTile with optional multi-hued ThermoBond finish.

WARRANTY

GrandeTile features a non-prorated Lifetime / 40 Year Limited Warranty, transferable to all future owners. This valuable warranty includes fade and chalk coverage.

DRAIN CHANNEL



GrandeTile includes a patented drain channel. Hidden in the overlap between neighboring panels, the drain channel provides added protection in the event of the fiercest wind-driven rain and snow storms. This redundant protection ensures the weathertightness and long life of your roof.

THERMOBOND COATING

Our proprietary ThermoBond finish adds an additional layer of PVDF powder coating on top of the product's initial Kynar 500[®] or Hylar 5000[®] finish.



ThermoBond features a blend of colors as well as a distinctive and inviting texture to make GrandeTile look naturally weathered, further enhancing its beauty.

Color Selection



GrandeTile Installed



85 Chicago Blvd in 1974 HDC photo



Note:
Roof color
is brown,
not green

85 Chicago Blvd circa 1920



Dr. James Cleland, Jr.

45 Chicago Boulevard

85 Chicago Blvd circa 1920

(Using A.I. software to add color to photo)



Note:
Roof color
is brown,
not green

Proposals Needing Approval (6/6)

- Installation of new gutter system
 - No gutters are currently present on the home
 - Gutter system to match fascia, soffit color (bronze 818)
 - New gutter collector boxes will be added along front side of home facing Chicago Blvd to bring back original historic elements

GUTTER ACCESSORIES

6INM



6" INSIDE MITRE
See pg. 32 for Color Legend
CARTON CONTENTS
• 20 Pieces Per Carton
• 12 Lbs.

60TM



6" OUTSIDE MITRE
See pg. 32 for Color Legend
CARTON CONTENTS
• 20 Pieces Per Carton
• 12 Lbs.

6ENL



6" LEFT END CAP
See pg. 32 for Color Legend
CARTON CONTENTS
• 50 Pieces Per Carton
• 5 Lbs.

6ENR



6" RIGHT END CAP
See pg. 32 for Color Legend
CARTON CONTENTS
• 50 Pieces Per Carton
• 5 Lbs.

6OUT



3" X 4"
OUTLET TUBE
Mill Finish
CARTON CONTENTS
• 30 Pieces Per Carton
• 3 Lbs.

8SPKA



8" SPIKES
130° Low Gloss White
CARTON CONTENTS
• 500 Pieces Per Carton
• 17 Lbs.

6PIPE CLIPS



6" PIPE CLIPS
130 Low Gloss
180 High Gloss
202 Royal Brown
238 Hickory
250 Musket Brown
325 Standstone Beige
360 Terratone
713 Wicker
818 Bronze
820 Cranberry
CARTON CONTENTS
• 50 Pieces Per Carton
• 4 Lbs.

6HHSREW



6" HIDDEN HANGER
WITH SCREWS
Mill Finish
CARTON CONTENTS
• 300 Pieces Per Carton
• 27 Lbs.

6FUNW130



3" X 4" FUNNEL
130° Low Gloss
CARTON CONTENTS
• 12 Pieces Per Carton
• 4 Lbs. Per Box

6 LEAFDROP



6" LEAF COVER
CARTON CONTENTS
• 50 Pieces • 4 Ft. Lengths
• 18 Lbs.

6HDHNGER

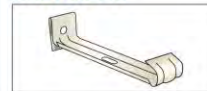

6" HIDDEN HANGER
Mill Finish
CARTON CONTENTS
• 100 Pieces Per Carton
• 25 Lbs.

GW6WH



6" GUTTER WEDGE
White Only
CARTON CONTENTS
• 50 Pieces Per Carton
• 8 Lbs.

6GLD



6" GUTTERLOCK DIAMOND
200 Black
280 White
CARTON CONTENTS
• 50 Pieces Per Carton
• 6 Ft. Per Piece
• 300 Ft. Per Carton

GUTTER ACCESSORIES

6CP



3" X 4" CONDUCTOR PIPE
See pg. 32 for Color Legend
CARTON CONTENTS
• (10) 10 Ft. Pieces
• 100 Ft. Per Carton • 30 Lbs.

6AE



STYLE A ELBOW
75° Degree Bend
See pg. 32 for Color Legend
CARTON CONTENTS
• 15 Pieces Per Carton
• 6 Lbs.

6BE

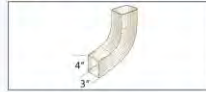

STYLE B ELBOW
75° Degree Bend
See pg. 32 for Color Legend
CARTON CONTENTS
• 15 Pieces Per Carton
• 6 Lbs.

6LNAE

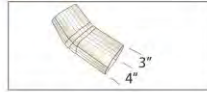

LONGNOSE A ELBOW
30° Bend
130° Low Gloss White
180° High Gloss White
202 Royal Brown
CARTON CONTENTS
• 24 Pieces Per Carton • 6 Lbs.

6ISM

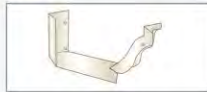

6" INSIDE STRIP MITRE
130° Low Gloss White
180° High Gloss White
202 Royal Brown
238 Hickory
250 Musket Brown
325 Sandstone Beige
360 Terratone
713 Wicker
791 Norwegian Wood
CARTON CONTENTS
• 20 Pieces Per Carton
• 4 Lbs.

6OSM

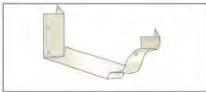

6" OUTSIDE STRIP MITRE
130° Low Gloss White
180° High Gloss White
202 Royal Brown
238 Hickory
250 Musket Brown
325 Sandstone Beige
360 Terratone
713 Wicker
791 Norwegian Wood
CARTON CONTENTS
• 20 Pieces Per Carton
• 4 Lbs.

6BIS

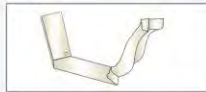

6" BAY INSIDE STRIP MITRE
130° Low Gloss White
CARTON CONTENTS
• 20 Pieces Per Carton
• 4 Lbs.

6BOS

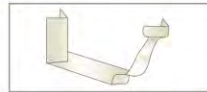

6" BAY OUTSIDE STRIP MITRE
130° Low Gloss White
CARTON CONTENTS
• 20 Pieces Per Carton
• 4 Lbs.

6KREJ



6" RUBBER EXPANSION JOINT
Mill Finish
CARTON CONTENTS
• 12 Pieces Per Carton
• 4 Lbs.

3X4YD



3" X 4" Y DIVERTERS
130° Low Gloss White
CARTON CONTENTS
• 10 Pieces Per Carton • 7 Lbs.



Gutter Profile Dimensions

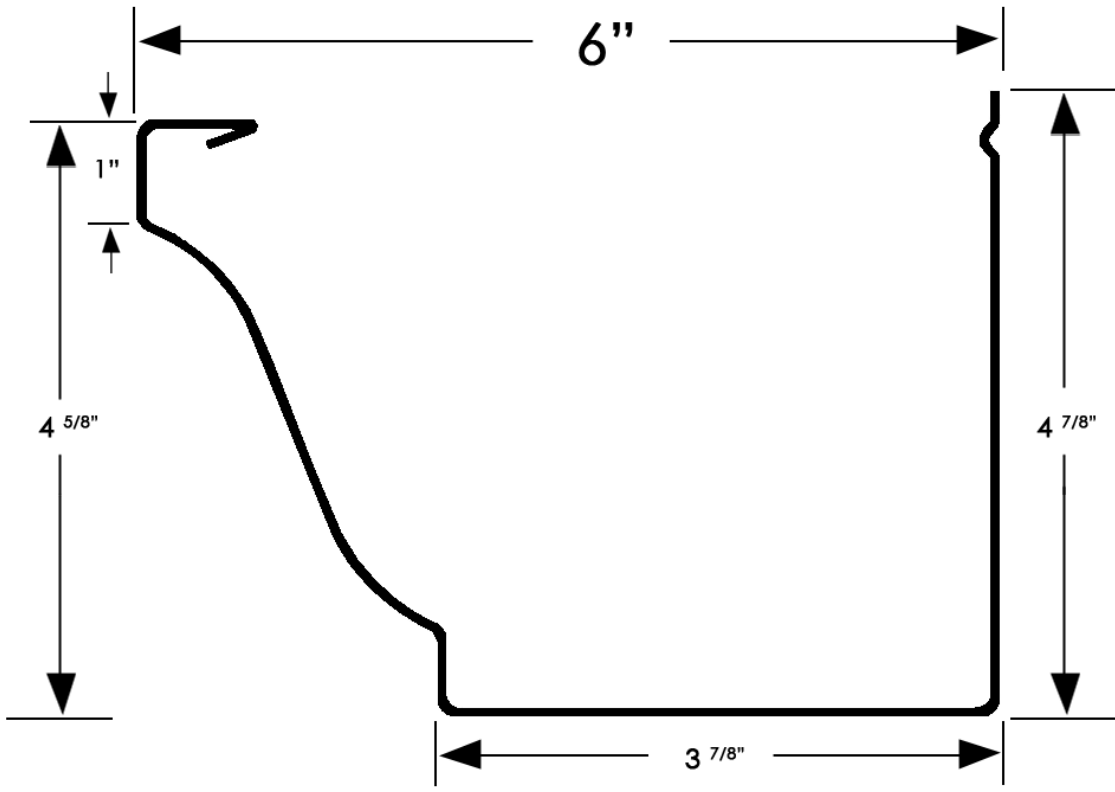

Gutter Side Cut



Proposed Gutter Color



818 - BRONZE

Gutter Collector Boxes



Gutter Collector Boxes



Note: Will match gutter system color.
Shown in white for details.

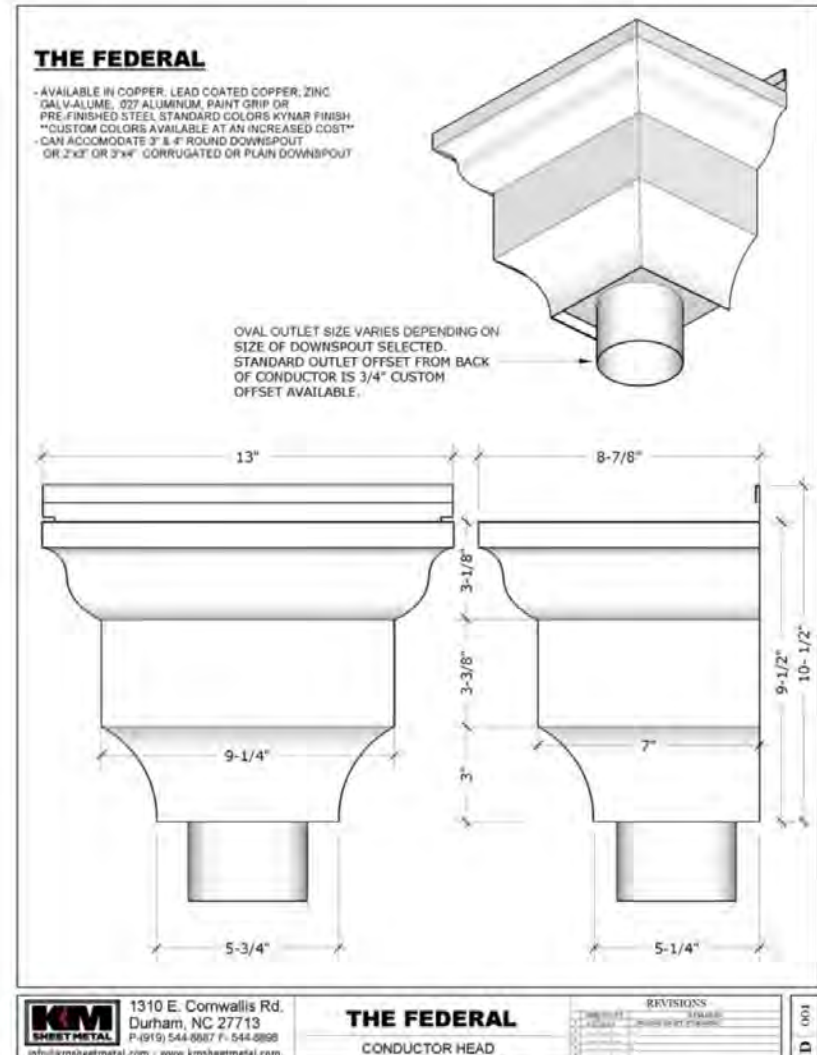

Thank you for your consideration!

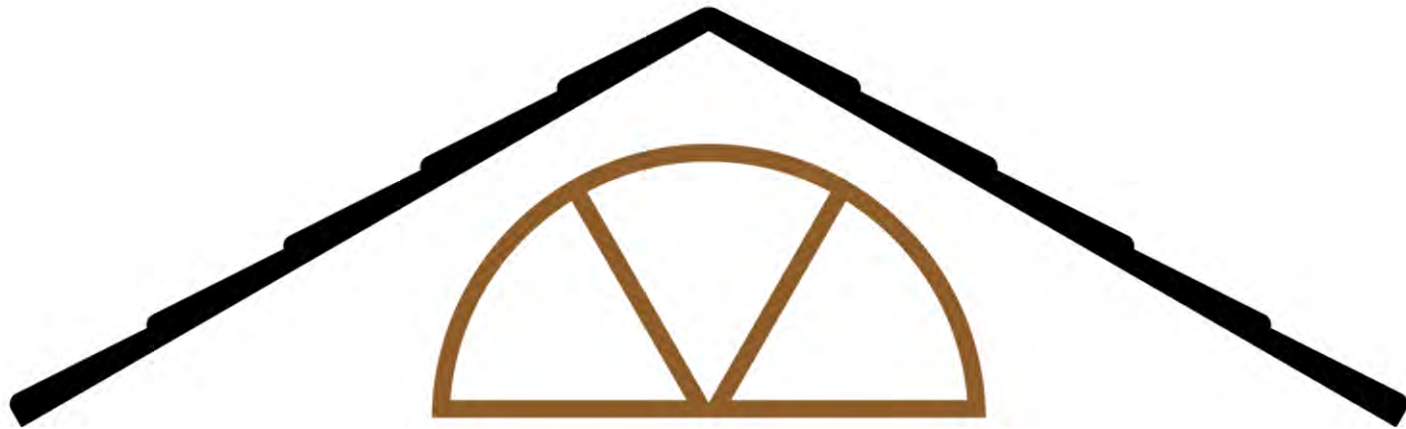

ALEXANDRIA

WINDOWS ♦ DOORS ♦ METAL ROOFING