

# DHDC 23-8517

## APPROVAL DOCUMENT – POST AT WORK LOCATION

CITY OF DETROIT  
HISTORIC DISTRICT COMMISSION

2 WOODWARD, SUITE 808  
DETROIT, MICHIGAN 48226

10/17/23

### CERTIFICATE OF APPROPRIATENESS

Blake Hill  
McIntosh Poris Associates  
36801 Woodward Avenue, Suite 20  
Birmingham, MI 48009

**RE: Application Number 23-8517; 20119 Wisconsin (AKA 8730 Chippewa); William E. Higginbotham School Historic District**  
**Project Scope: Rehabilitate school building, erect multi-family buildings**

Dear Applicant,

At the Regular Meeting that was held on October 11, 2023, the Detroit Historic District Commission (“DHDC”) reviewed the above-referenced application. Pursuant to Section 5(1) of the Michigan Local Historic District Act, as amended, being MCL 399.205 (1) and Sections 21-2-73/21-2-78 of the 2019 Detroit City Code; the DHDC hereby issues a Certificate of Appropriateness (“COA”) for the following work, effective on October 17, 2023, as it meets the Secretary of Interior’s Standards for Rehabilitation and the district’s Elements of Design:

- ***Rehabilitate school building, erect multi-family buildings***

Please retain this COA for your files and post it at the subject property until work is complete. It is important to note that approval by the DHDC does not waive the applicant's responsibility to comply with any other applicable ordinances or statutes. If you have any questions regarding the foregoing, please contact staff at 313-224-1762 or [hdc@detroitmi.gov](mailto:hdc@detroitmi.gov).

For the Commission:



Garrick B. Landsberg, Director



# HIGGINBOTHAM SCHOOL







# TABLE OF CONTENTS

## PROJECT OVERVIEW

- HISTORY + DESIGN NARRATIVE
- EXISTING CONDITIONS
- SITE CONTEXT

## ARCHITECTURAL DRAWINGS

- SITE PLAN
- SCHOOL
  - FLOOR PLANS
  - EXTERIOR ELEVATIONS
  - EXTERIOR ELEVATIONS - LIGHTING
  - PROPOSED DETAILS AND SPECS

## GARDEN APARTMENTS

- FLOOR PLANS
- EXTERIOR MATERIALS
- EXTERIOR ELEVATIONS

## STREET ELEVATIONS

- RENDERINGS
- MEP SIGHT LINE VIEWS

## APPENDIX

- WINDOW ASSESSMENT



# HISTORY + DESIGN NARRATIVE

The Higginbotham School is located in the 8-Mile/Wyoming neighborhood, which was a historically working-class African American community that was settled in the early 1920s when the area was largely undeveloped. Restrictive covenants did not exist in this remote location, enabling homeownership when it was simply not an option for most Black families in Detroit. Higginbotham School served as Detroit's all Black elementary school for over eighty years, which as a result of both de facto segregation (happening in reality) practiced in Detroit and of the de jure segregation (happening according to law) that resulted from federal housing policies.

The project aims to deliver historically significant, high-quality rental units at an affordable price. Targets for the project include 100 low-income apartments and a 2,000 square foot auditorium designed to accommodate a variety of community functions, plus approximately 100 spaces of off-street parking. The historic school will be historically rehabilitated, and two new "garden apartment" buildings will also be constructed on the site. The landscape design includes a private courtyard, public play areas, native plantings, and curated art and sculpture made by local artists. The development team is seeking Historic Tax Credits, as well as MSHDA Low-Income Housing Tax Credits.

Existing elements such as the clay tile roof and existing masonry will be repaired or replaced in-kind per the Secretary of the Interior Standards for Rehabilitation. The existing wood-framed (and steel) windows and doors are beyond repair and new, historically-replicated aluminum products are proposed as replacement (reference the attached Window Assessment for more information). The new garden apartments are sited along Indiana (continuing the street edge of the school) and along the east edge of the property, effectively creating an internal street, or "mews." The east-facing garden apartments are intentionally set back from the front face of the school so that the historic entrance remains visible from Chippewa. The front yard of the site is designed to be public oriented with a play area, sculpture garden, and a curb-less "parking plaza" that will serve as a gathering space for events at the auditorium and provide required accessible parking spaces. The new parking lots will be set back and screened according to zoning requirements, but using all-season native plantings wherever possible. To ensure security and safety for residents, a fence and gate strategy encloses the more private areas, with the buildings themselves acting as a large portion of the fence. The existing material palette, overall scale, and window proportions of the existing school were all key features that informed the design of the new garden apartments. The exterior materials are intentionally darker in color (with the burgundy color pop being lifted from the accent brick from the school) to compliment the school without visually dominating it.

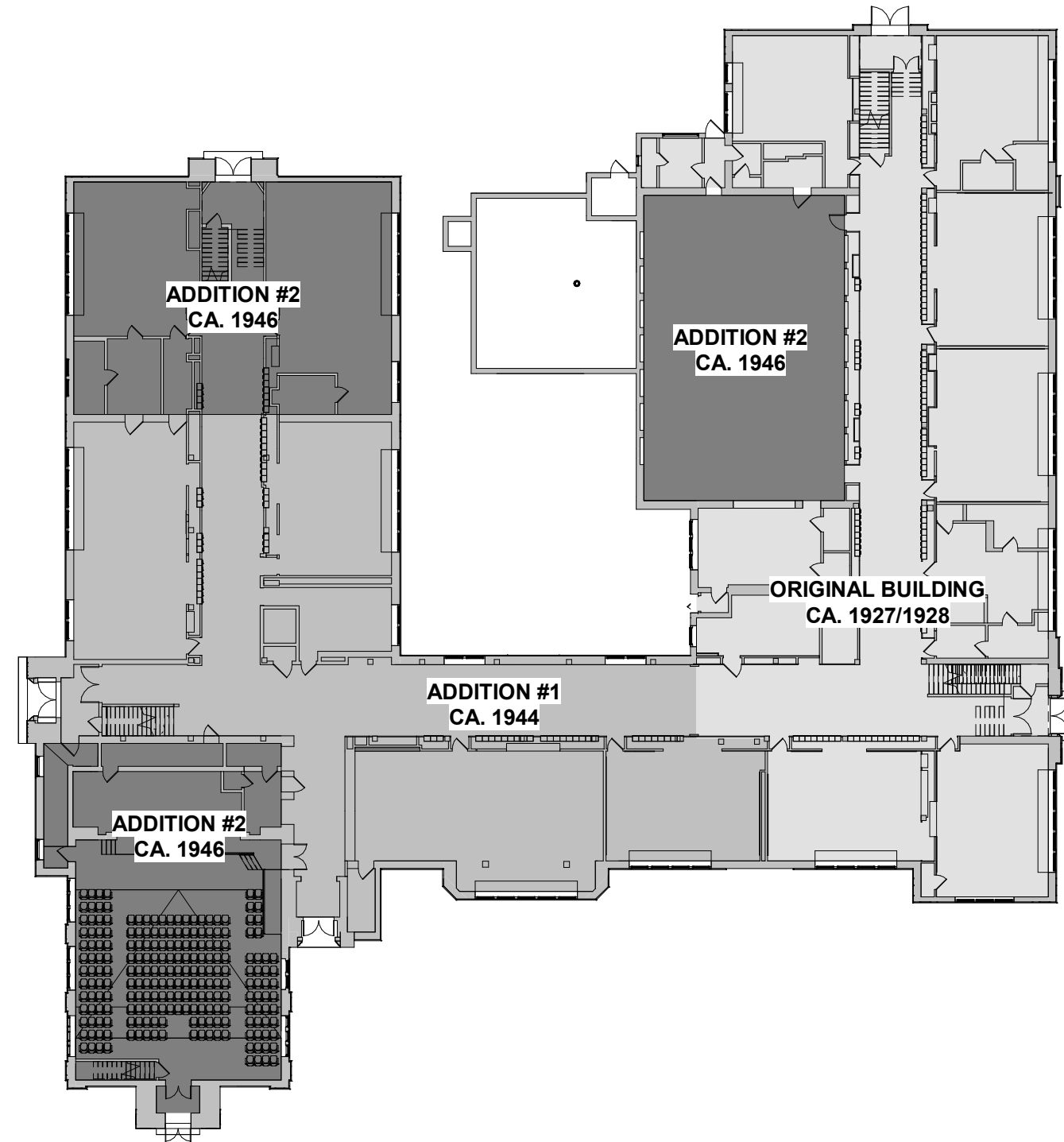



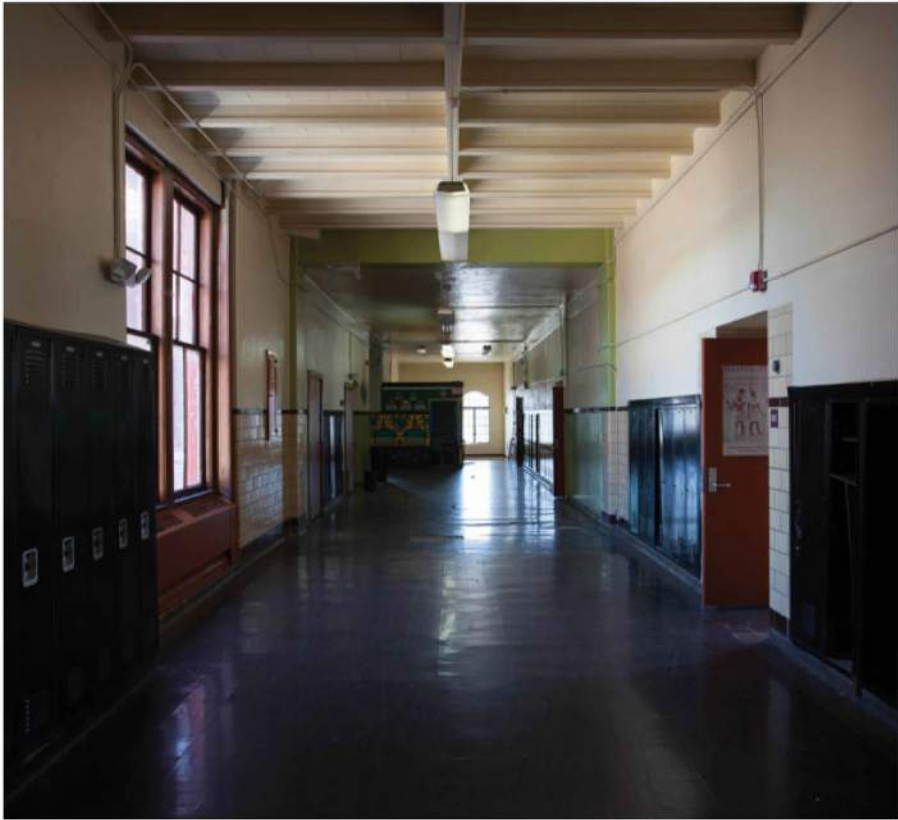



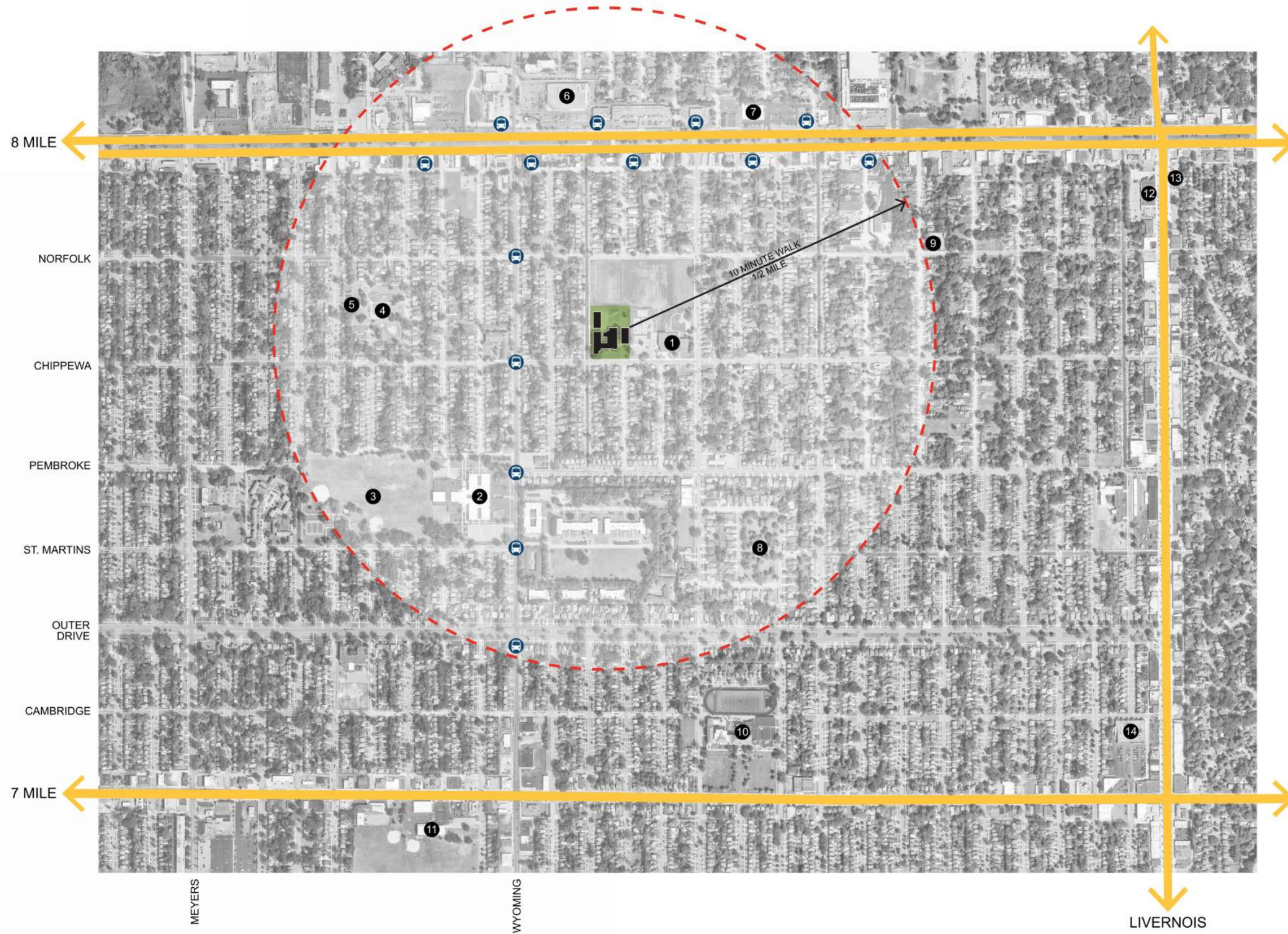

**KEY**

- ① U OF D JESUIT JOHNSON REC CENTER
- ② BATES ACADEMY
- ③ VAN ANTWERP PARK
- ④ ALFONSO WELLS MEMORIAL PLAYGROUND
- ⑤ BIRWOOD WALL
- ⑥ KROGER
- ⑦ ALDI
- ⑧ ST. MARTINS PARK
- ⑨ 8 MILE RD OLD TIMERS CLUB
- ⑩ U OF D JESUIT HIGH SCHOOL AND ACADEMY
- ⑪ TINDAL ACTIVITY CENTER
- ⑫ US POSTAL SERVICE
- ⑬ BAKER'S KEYBOARD LOUNGE
- ⑭ MIKE'S FRESH MARKET
- 🚌 DDOT BUS STOP



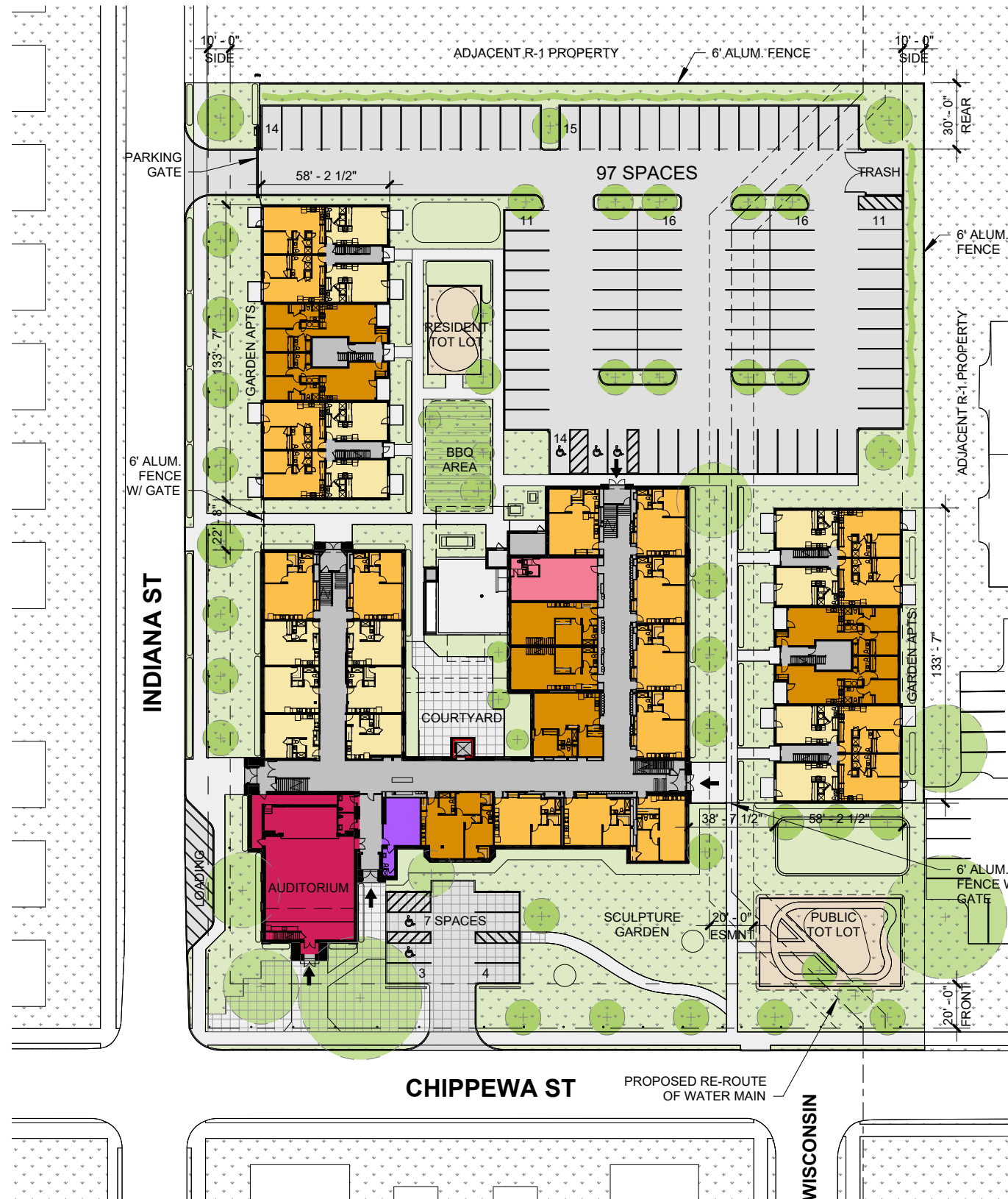

**SITE PLAN KEY**

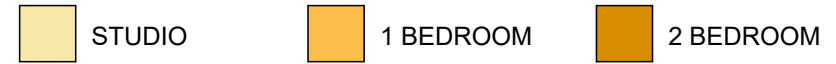

**BUILDING DATA**

DATA	UNIT COUNT	GROSS SF	RENTABLE SF
SCHOOL	40	54,295* SF	27,580 SF
GARDEN APTS.	60	45,410 SF	38,540 SF
<b>TOTAL</b>	<b>100</b>	<b>99,705 SF</b>	<b>66,120 SF</b>

\*SCHOOL GROSS AREA INCLUDES BASEMENT

UNIT MIX	STUDIO	ONE BED	TWO BED/LOFT
SCHOOL	10	24	6
GARDEN APTS.	24	24	12
<b>TOTAL</b>	<b>34</b>	<b>48</b>	<b>18</b>

**PARKING REQUIREMENTS**

PARKING	DET. ZONING	MSHDA
SCHOOL	30 SPACES	80 SPACES
GARDEN APTS.	45 SPACES	120 SPACES
<b>TOTAL PARKING REQUIRED:</b>	<b>75 SPACES</b>	<b>200 SPACES</b>

REMAINING AUDITORIUM PARKING:      29 SPACES      0 SPACES

**TOTAL PARKING PROVIDED:      104 SPACES + (1) 12'X35' LOADING**



# TOTAL BUILDING DATA: SCHOOL



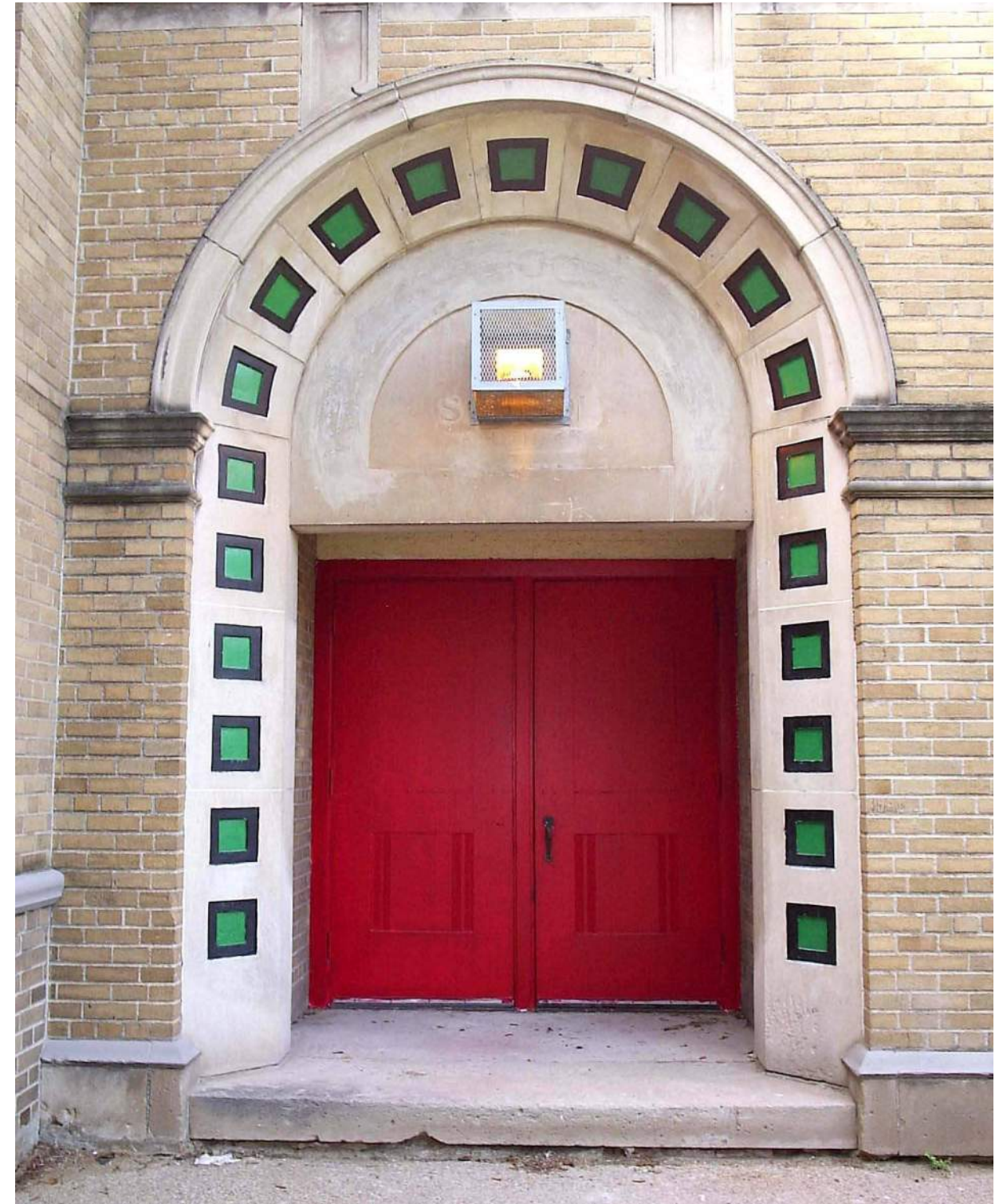

	COUNT	NET AREA
STUDIO	10	5,180 SF
1 BEDROOM	24	16,505 SF
2 BEDROOM / LOFT	6	5,895 SF
AUDITORIUM		3,465 SF
LEASING OFFICE		415 SF
FITNESS CENTER		760 SF
CORRIDOR		11,665 SF
STAIR / ELEVATOR		1,410 SF
UTILITY / MEP		5,140 SF
<b>TOTALS</b>	<b>40</b>	
<b>NET RENTABLE (RESIDENTIAL)</b>		<b>27,580 SF</b>
<b>GROSS</b>		<b>54,295 SF</b>
<b>EFFICIENCY</b>		<b>51%</b>

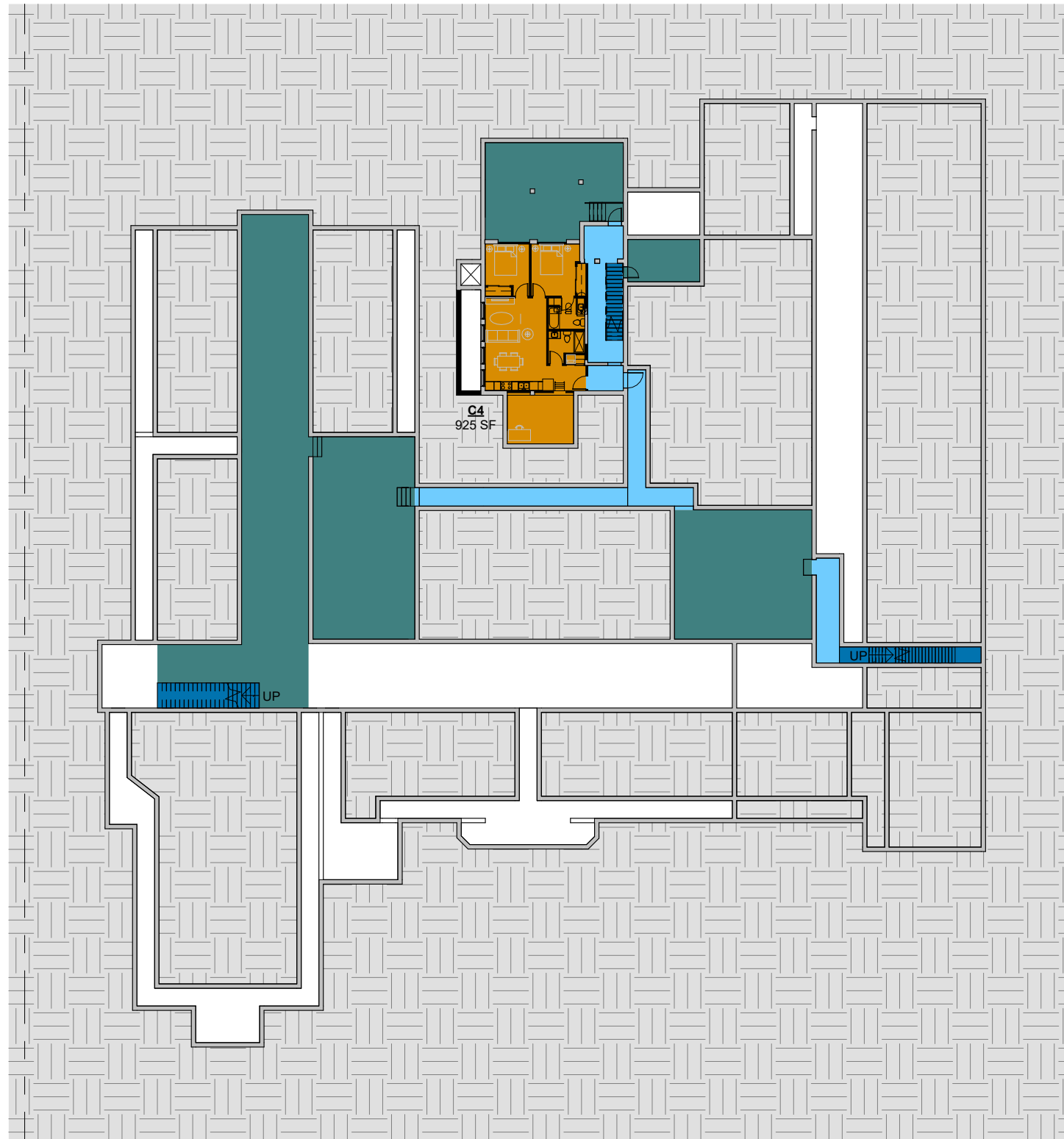





**BASEMENT FLOOR DATA**

	COUNT	NET AREA
 2 BEDROOM / LOFT	1	935 SF
 CORRIDOR		775 SF
 STAIR / ELEVATOR		315 SF
 STORAGE / MEP		4,760 SF
<b>TOTALS</b>	<b>1</b>	
<b>NET RENTABLE</b>		<b>935 SF</b>
<b>GROSS</b>		<b>7,640 SF</b>





**GROUND FLOOR DATA**

	COUNT	NET AREA
STUDIO	6	3,115 SF
1 BEDROOM	10	7,045 SF
2 BEDROOM / LOFT	4	4,025 SF
AUDITORIUM		2,910 SF
LEASING		415 SF
FITNESS CENTER		760 SF
CORRIDOR		5,980 SF
STAIR / ELEVATOR		445 SF
UTILITY / MEP		160 SF
<b>TOTALS</b>	<b>20</b>	
<b>NET RENTABLE</b>		<b>14,185 SF</b>
<b>GROSS</b>		<b>26,615 SF</b>
<b>EFFICIENCY</b>		<b>53%</b>



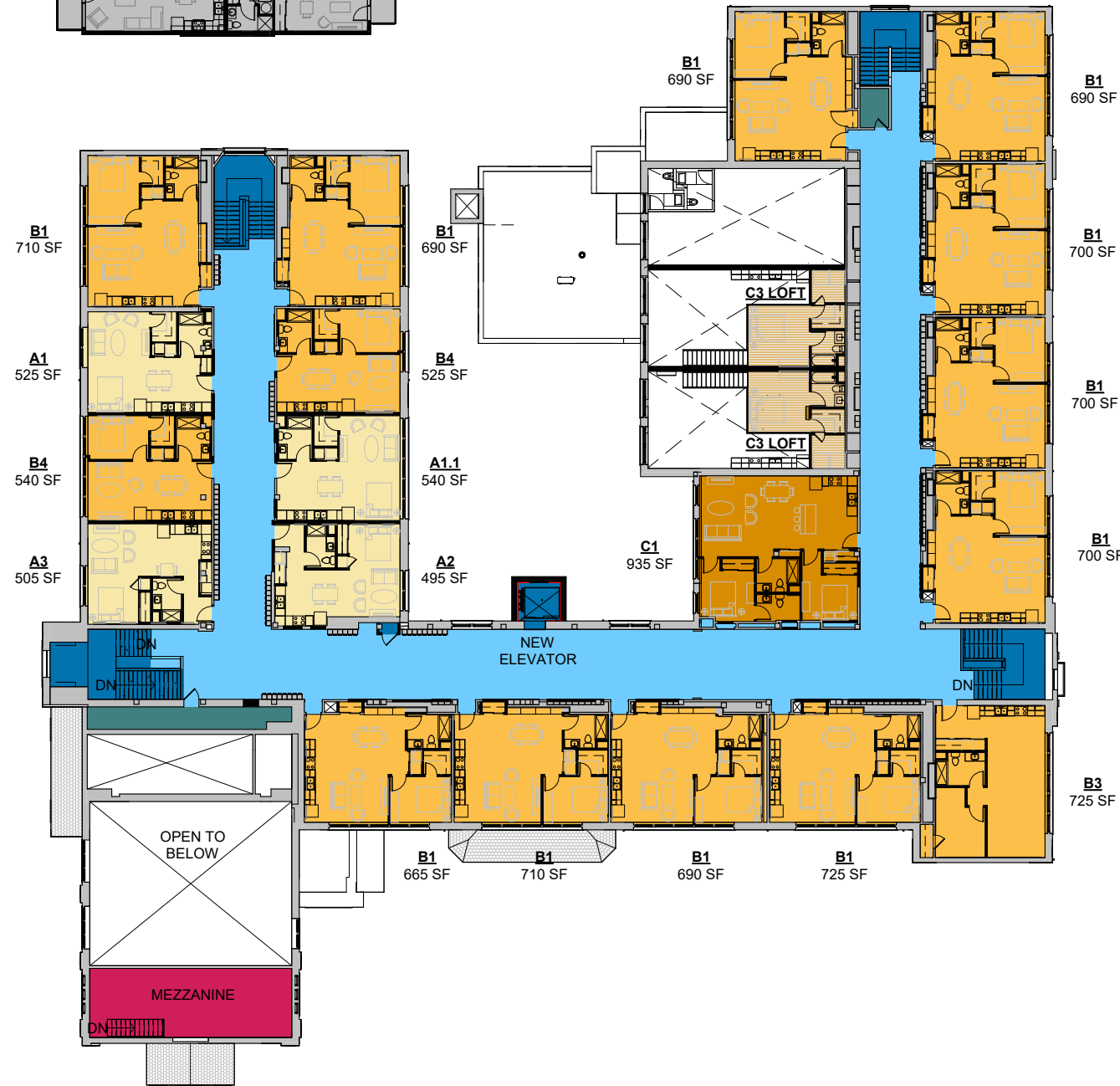
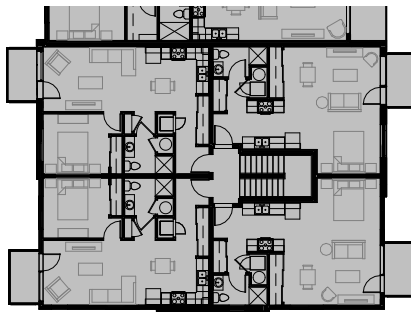

**SECOND FLOOR DATA**

	COUNT	NET AREA
STUDIO	4	2,065 SF
1 BEDROOM	14	9,460 SF
2 BEDROOM / LOFT	1	935 SF
AUDITORIUM		553 SF
CORRIDOR		4,910 SF
STAIR / ELEVATOR		650 SF
UTILITY / MEP		220 SF

**TOTALS** **19**

**NET RENTABLE** **12,460 SF**

**GROSS** **20,040 SF**

**EFFICIENCY** **62%**



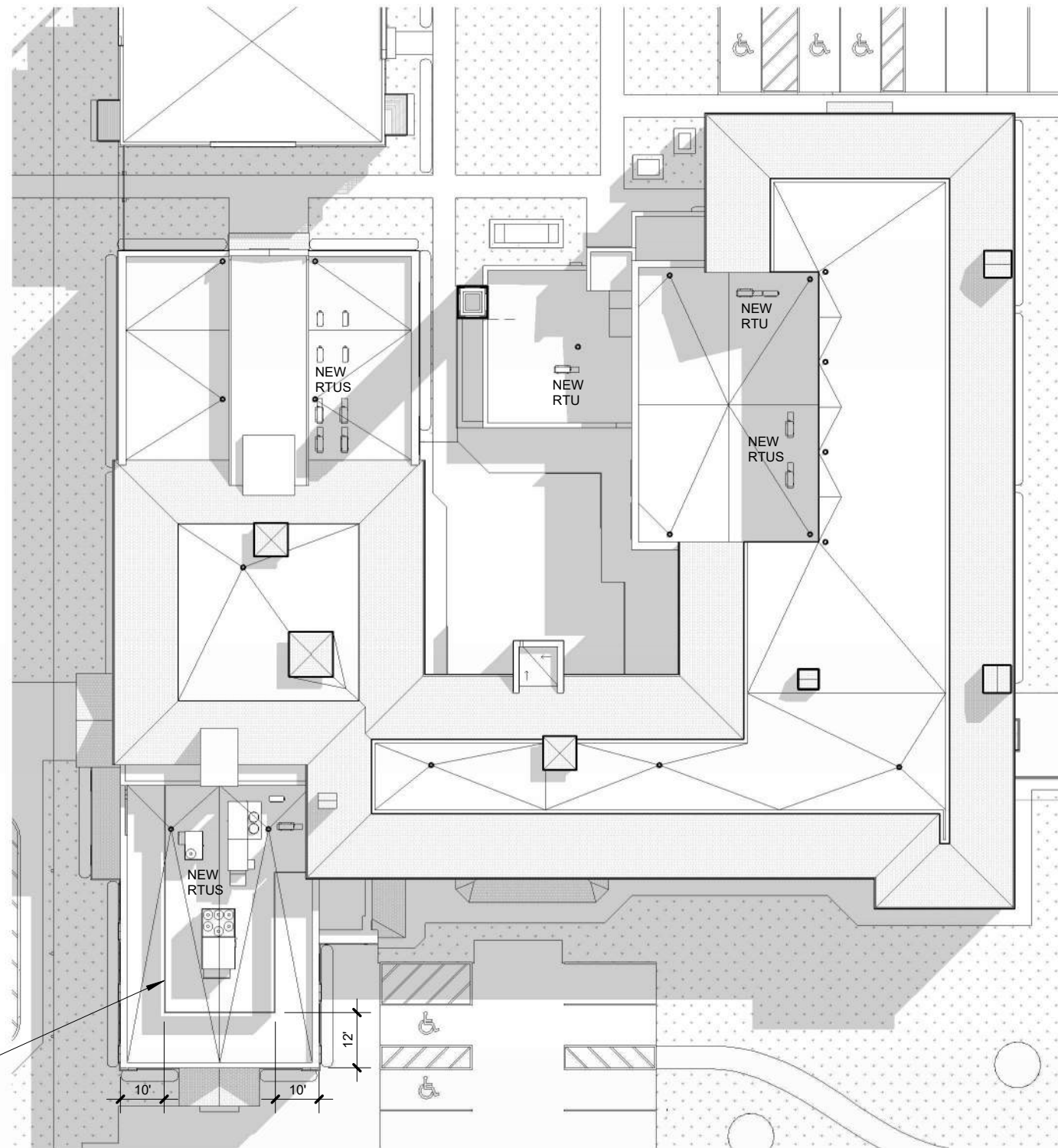

NEW PERFORATED  
METAL SCREEN WALL



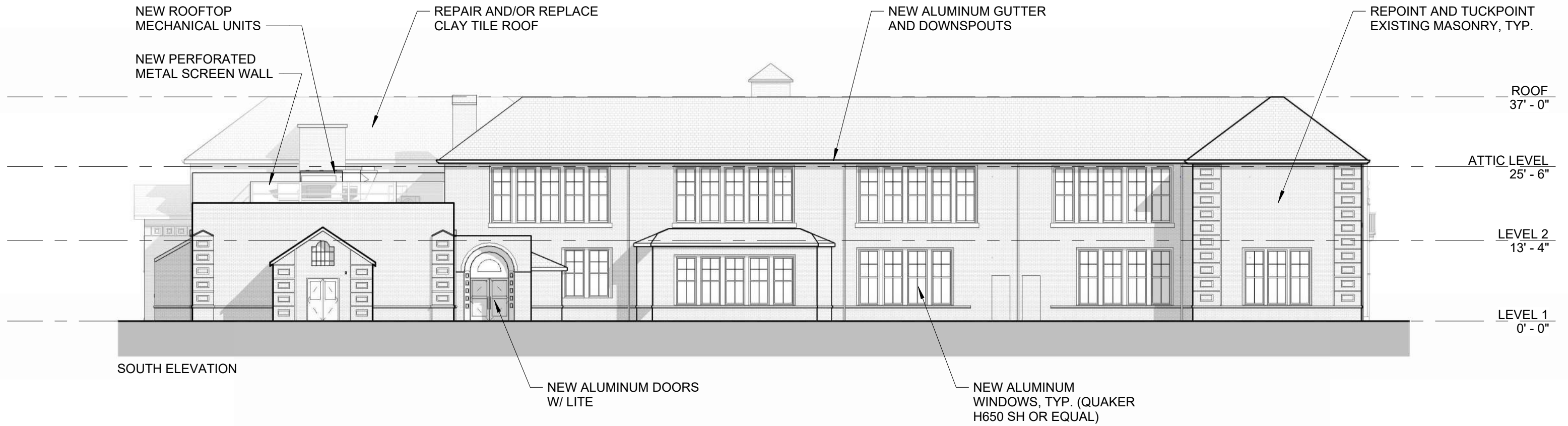
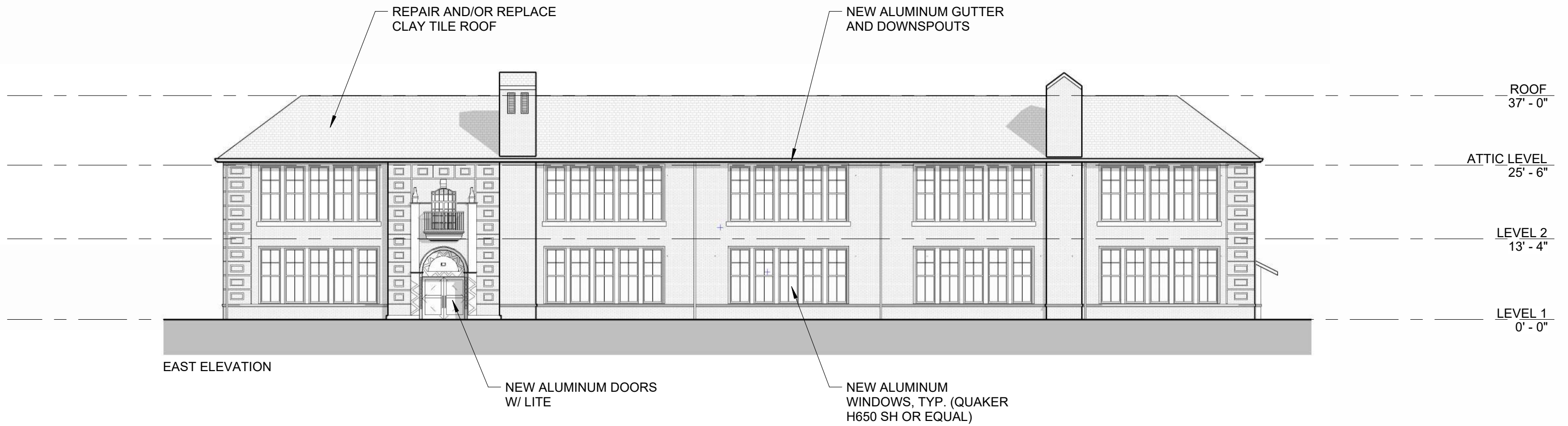



NEW ROOFTOP MECHANICAL UNITS

REPAIR AND/OR REPLACE CLAY TILE ROOF

NEW ALUMINUM GUTTER AND DOWNSPOUTS

NEW PERFORATED METAL SCREEN WALL

NEW ROOFTOP MECHANICAL UNITS

ROOF 37'-0"

ATTIC LEVEL 25'-6"

LEVEL 2 13'-4"

LEVEL 1 0'-0"

WEST ELEVATION

NEW ALUMINUM WINDOWS, TYP. (QUAKER H650 SH OR EQUAL)

NEW ALUMINUM DOORS W/ LITE

NEW ALUMINUM GUTTER AND DOWNSPOUTS

REPAIR AND/OR REPLACE CLAY TILE ROOF

NEW ROOFTOP MECHANICAL UNITS

REPOINT AND TUCKPOINT EXISTING MASONRY, TYP.

ROOF 37'-0"

ATTIC LEVEL 25'-6"

LEVEL 2 13'-4"

LEVEL 1 0'-0"

NORTH ELEVATION

NEW ALUMINUM DOORS W/ LITE

NEW ALUMINUM WINDOWS IN NEW OPENINGS

NEW ALUMINUM DOORS W/ LITE

NEW ALUMINUM WINDOWS, TYP. (QUAKER H650 SH OR EQUAL)



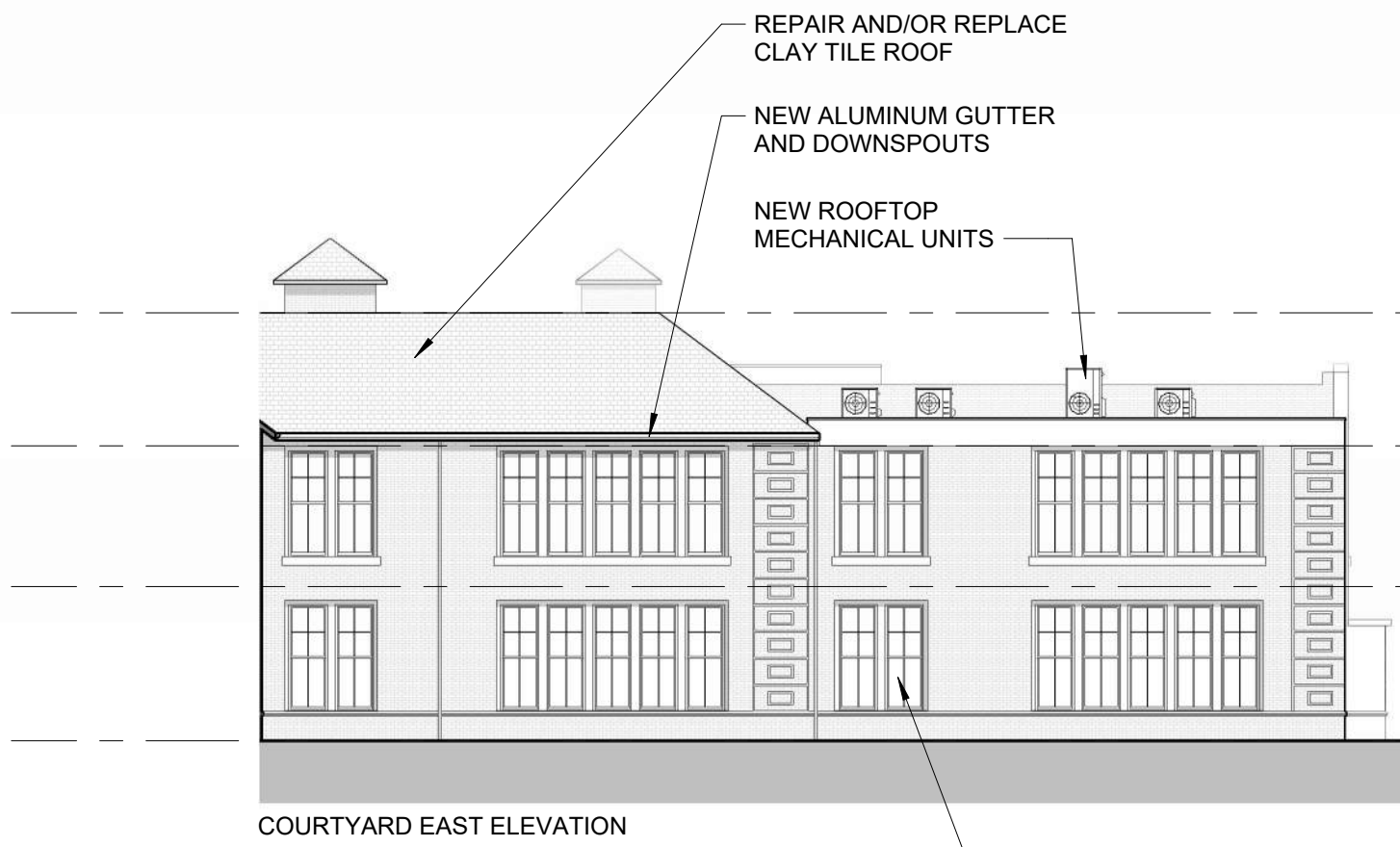

COURTYARD EAST ELEVATION

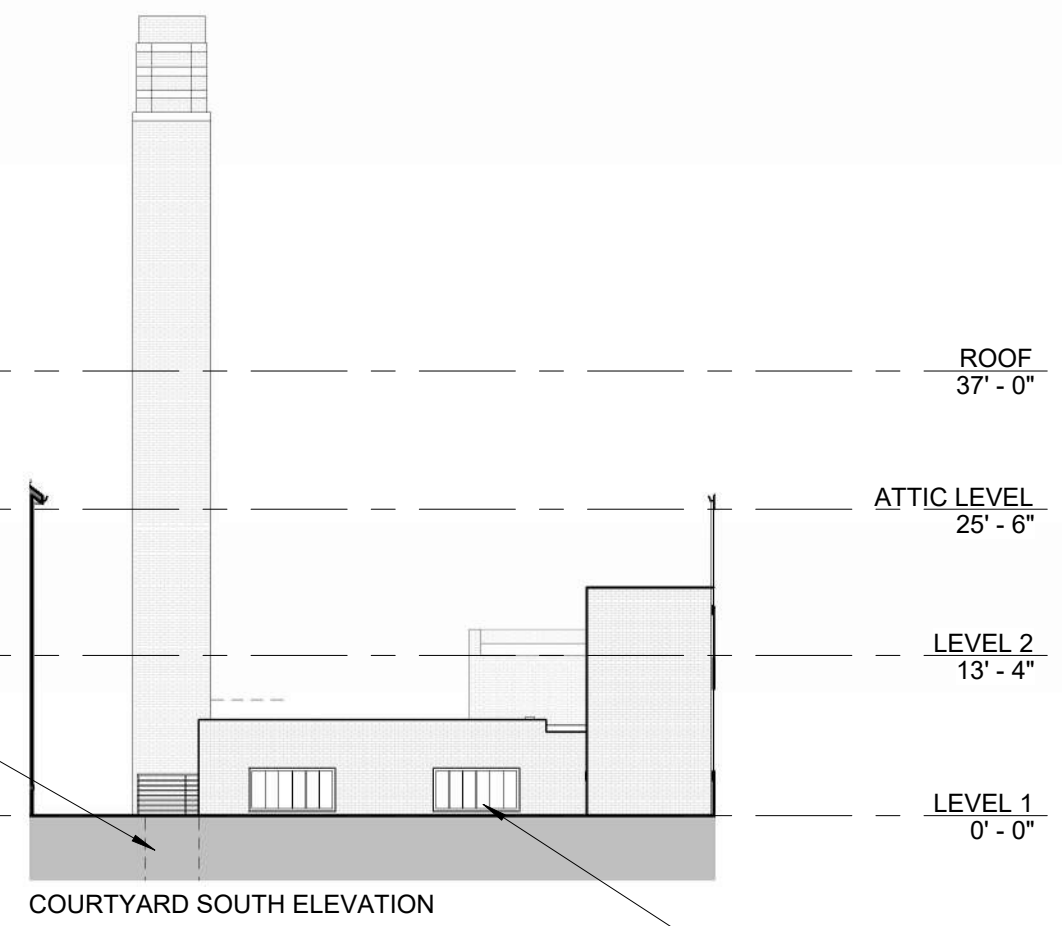

COURTYARD SOUTH ELEVATION

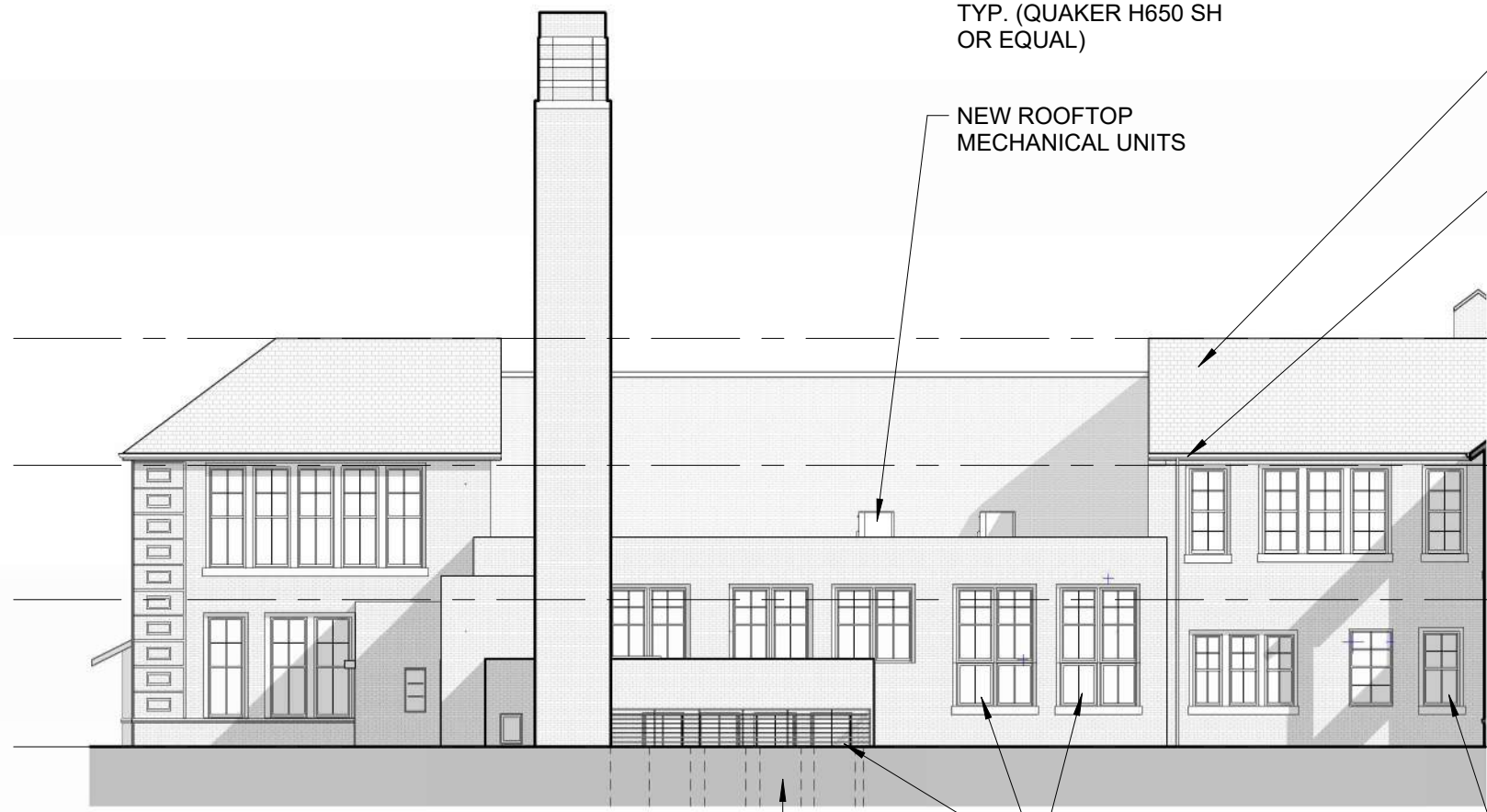

COURTYARD WEST ELEVATION

REPAIR AND/OR REPLACE CLAY TILE ROOF (ASSUME 50% REPLACEMENT)

NEW ALUMINUM GUTTER AND DOWNSPOUTS

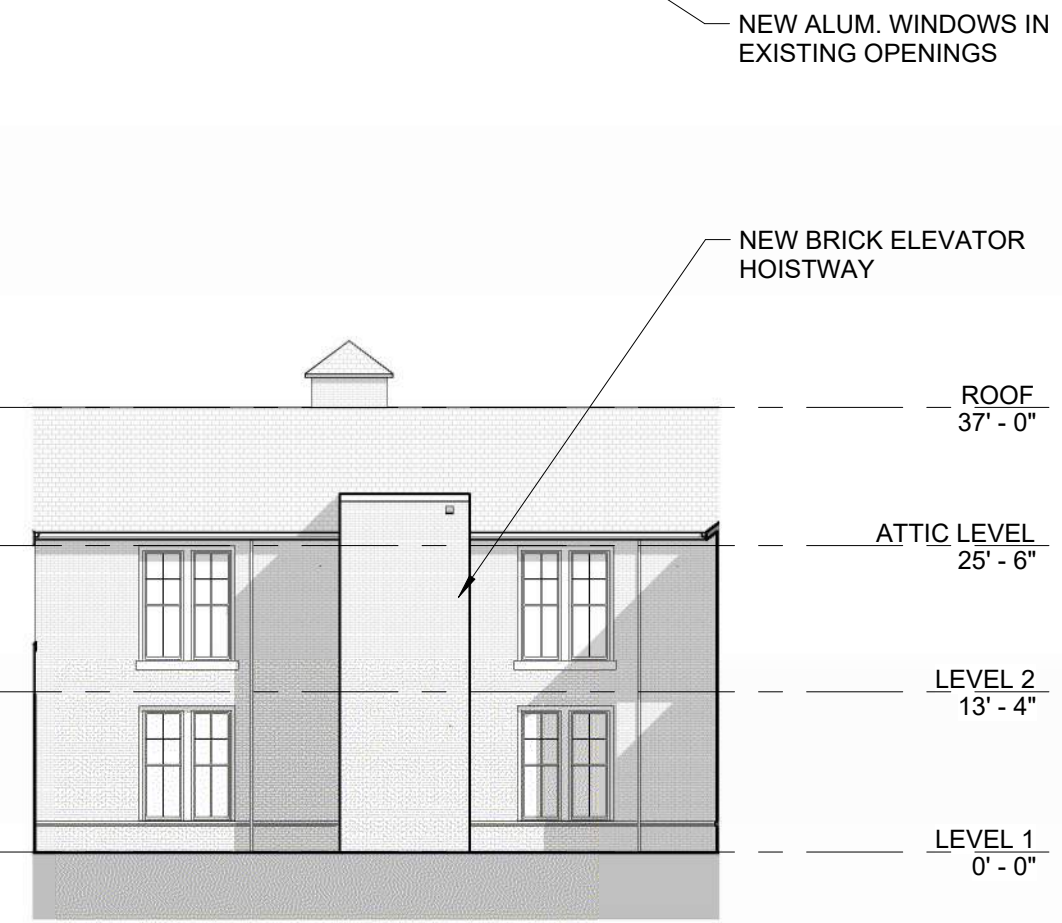

COURTYARD NORTH ELEVATION

NEW WINDOW WELL AND RAILING

NEW ALUM. WINDOWS IN NEW OPENINGS

NEW ALUM. WINDOWS, TYP. (QUAKER H650 SH OR EQUAL)



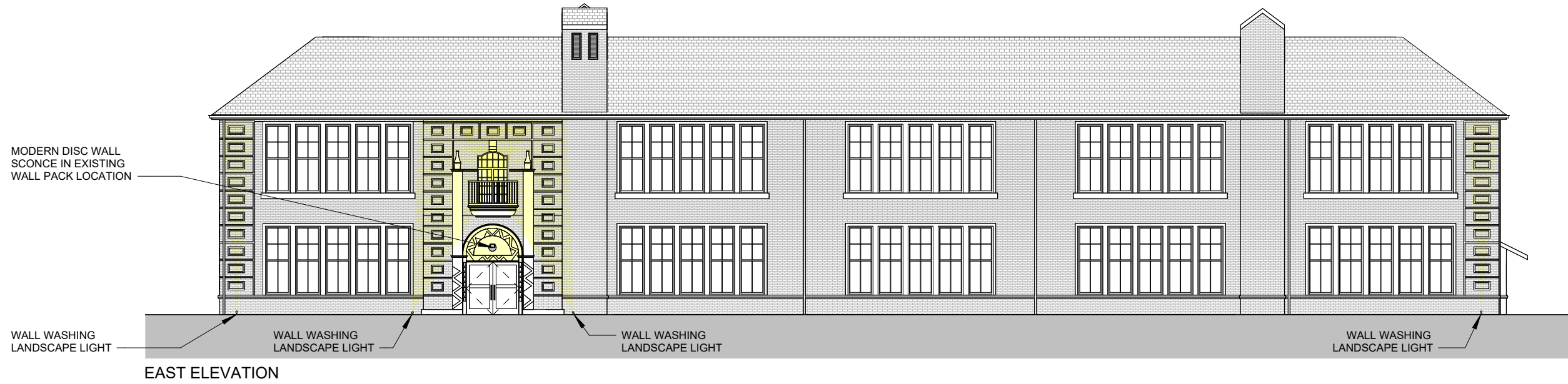

EAST ELEVATION

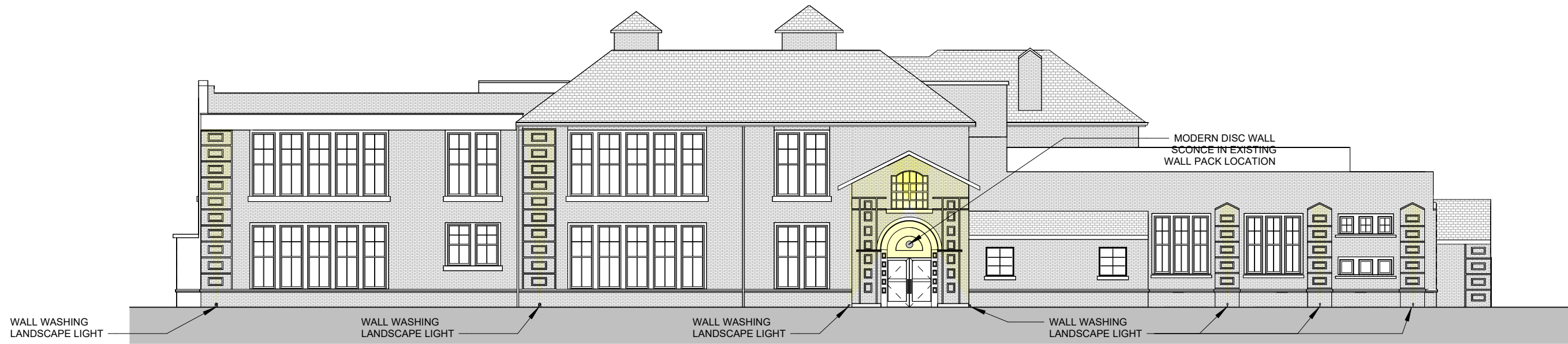

WEST ELEVATION



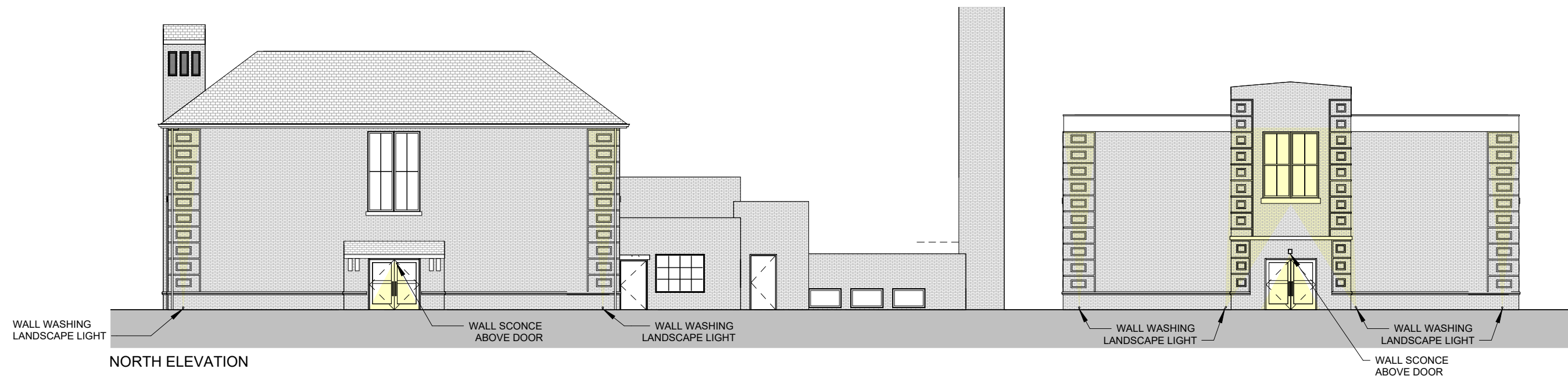



EXTERIOR

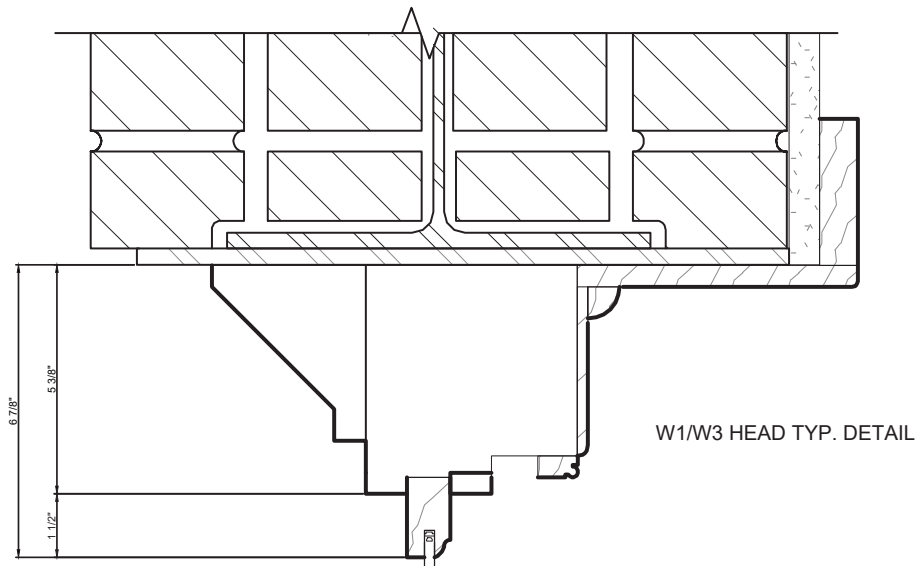

W1/W3 HEAD TYP. DETAIL

1  
C1

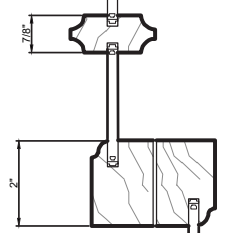

W1 MEETING RAIL DETAIL

2  
C1

3  
C1

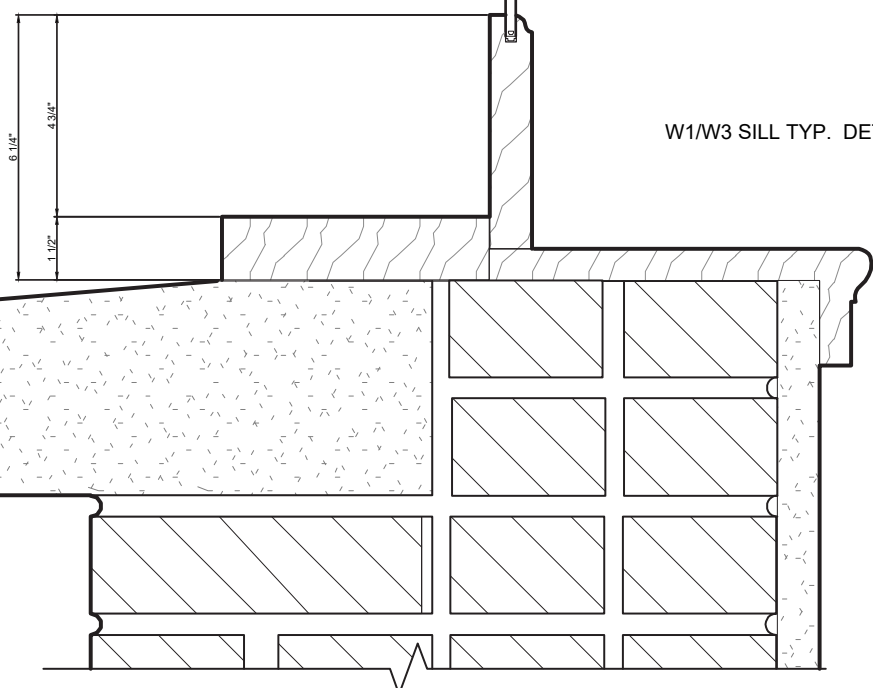

W1/W3 SILL TYP. DETAIL

4  
C1

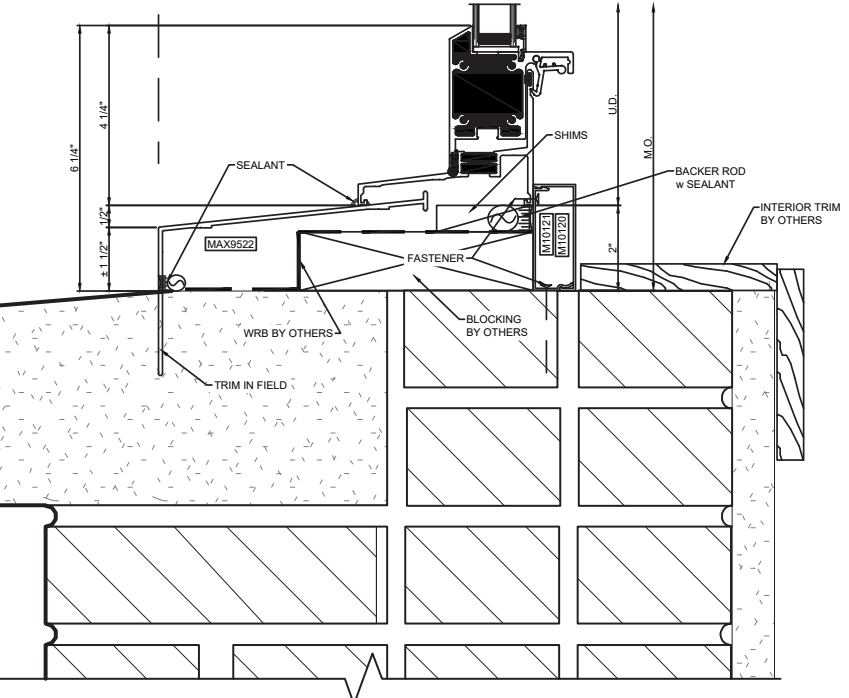
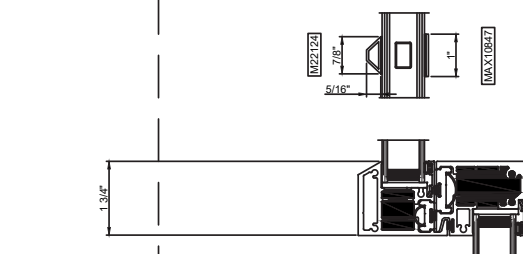
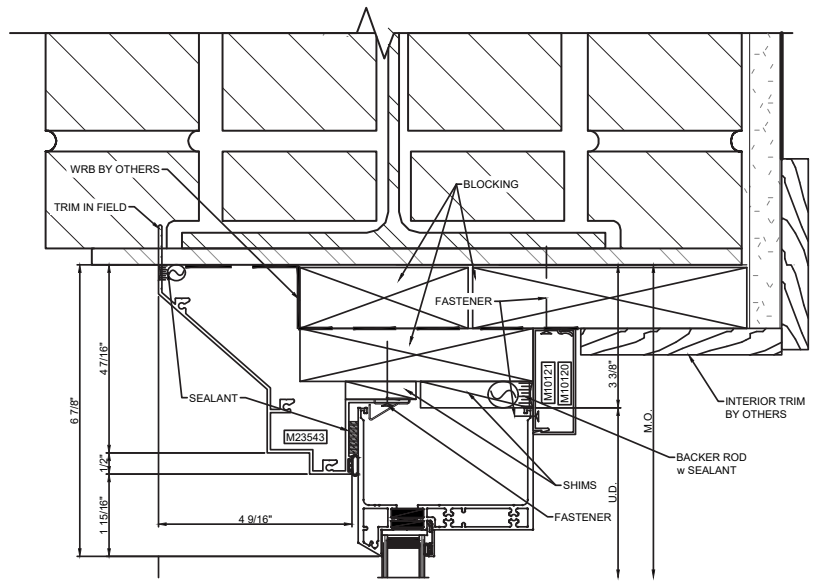

**NOTICE:**  
QUAKER DOES NOT SUPPLY ANY FASTENERS, SHIMS, BACKER ROD, OR SEALANTS, UNLESS OTHERWISE NOTED.

VERIFY INSTALLATION  
VERIFY WALL DETAILS

SEALANT MUST MEET OR EXCEED  
ASTM C920-11 SPECIFICATION

PROVIDE ADEQUATE BLOCKING TO  
SUPPORT THE SILL OF THE WINDOW

NAILING FLANGES AND DRIP  
CAPS (INTEGRAL OR APPLIED)  
DO NOT TAKE THE PLACE OF  
WINDOW FLASHING. ALL  
WINDOWS AND DOORS MUST  
BE PROPERLY FLASHED AND  
SEALED WITH MATERIAL  
COMPATIBLE SEALANT FOR  
PROTECTION AGAINST WATER  
AND INFILTRATION AROUND  
THE ENTIRE PERIMETER.  
FAILURE TO DO SO COULD  
RESULT IN PRODUCT OR  
PROPERTY DAMAGE.

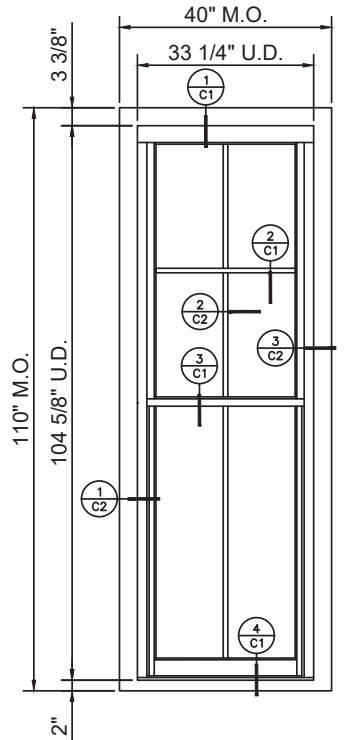

**TYPE W1A**  
H650 SH  
M23543 PRESET PANNING  
QTY. 151

Project Name: **HIGGINBOTHAM SCHOOL**  
**COMPARISONS**  
**DETROIT, MI**

Description: **CUT DETAILS**  
QUAKER WINDOW PRODUCTS  
WILL NOT BE RESPONSIBLE  
FOR FIELD MEASUREMENT,  
QUANTITIES, & INSTALLATION  
DESIGN. CONTRACTOR MUST  
VERIFY ALL DIMENSIONS.

PHONE (573)-744-5211  
FAX (573)-744-5586  
dgrimm@quakerwindows.com

**QUAKER**  
COMMERCIAL

Drawn By: DG  
Checked By: AGN

Scale: 1:4  
Sheet # C1

504 Highway 63 South  
Freeburg, MO 65035

Drawing Created  
8/11/23



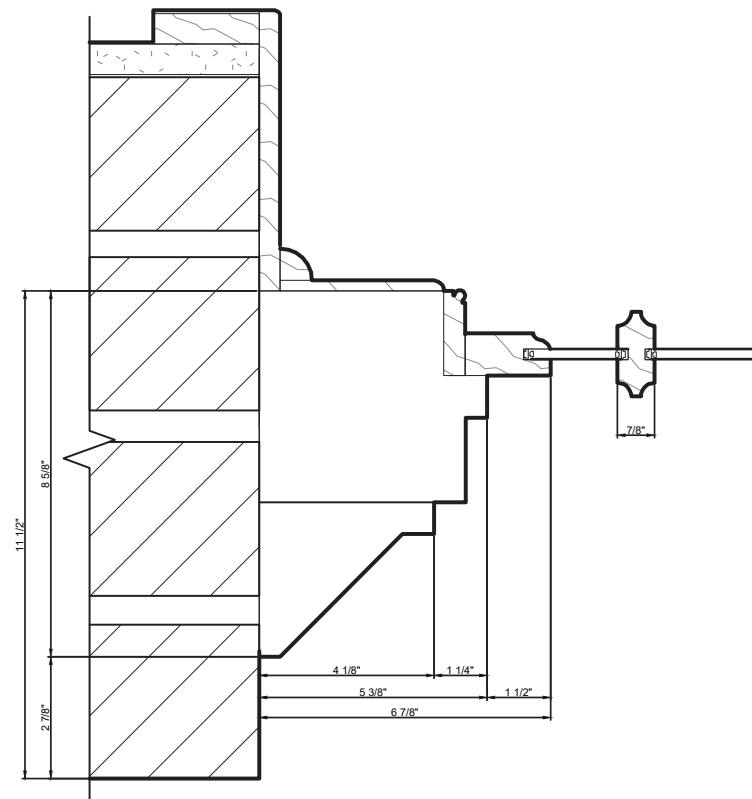

W1/W3 JAMB TYP. DETAIL

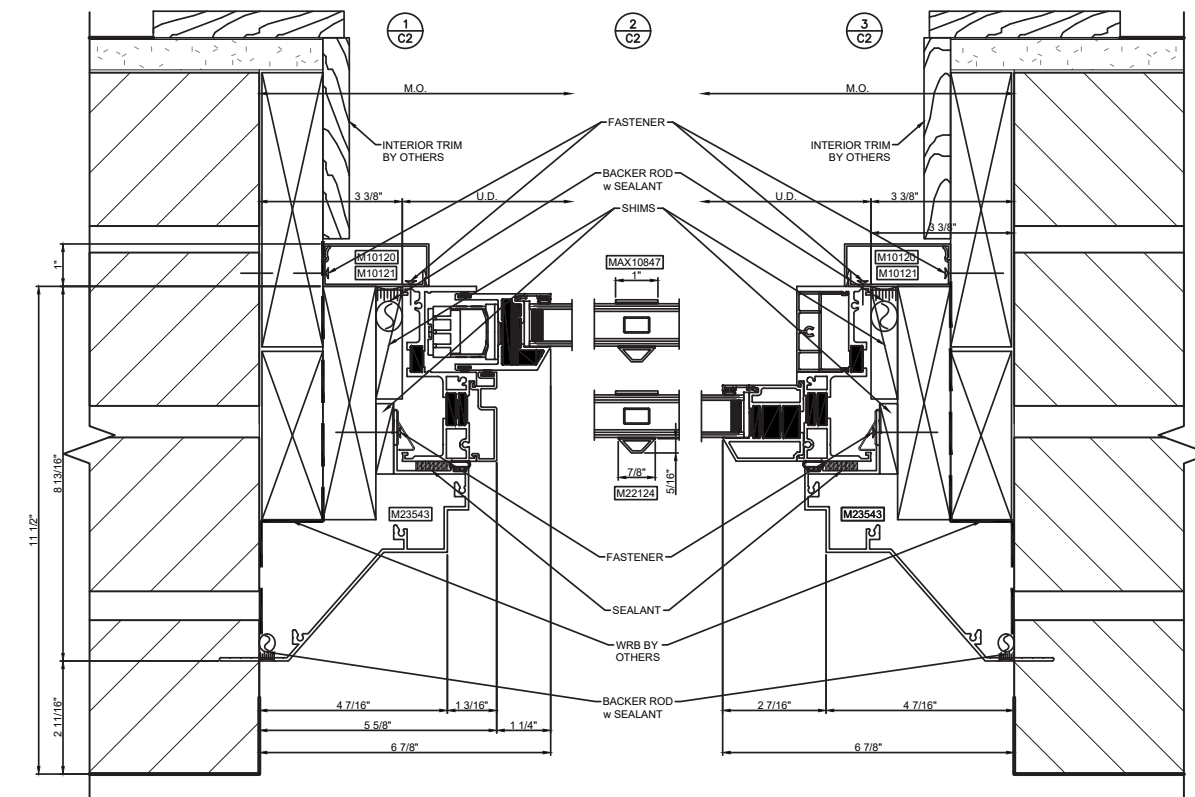

EXTERIOR

**NOTICE:**  
 QUAKER DOES NOT SUPPLY ANY FASTENERS, SHIMS, BACKER ROD, OR SEALANTS, UNLESS OTHERWISE NOTED

VERIFY INSTALLATION  
 VERIFY WALL DETAILS

SEALANT MUST MEET OR EXCEED ASTM C920-11 SPECIFICATION

PROVIDE ADEQUATE BLOCKING TO SUPPORT THE SILL OF THE WINDOW

NAILING FLANGES AND DRIP CAPS (INTEGRAL OR APPLIED) DO NOT TAKE THE PLACE OF WINDOW FLASHING. ALL WINDOWS AND DOORS MUST BE PROPERLY FLASHED AND SEALED WITH MATERIAL COMPATIBLE SEALANT FOR PROTECTION AGAINST WATER AND INFILTRATION AROUND THE ENTIRE PERIMETER. FAILURE TO DO SO COULD RESULT IN PRODUCT OR PROPERTY DAMAGE.

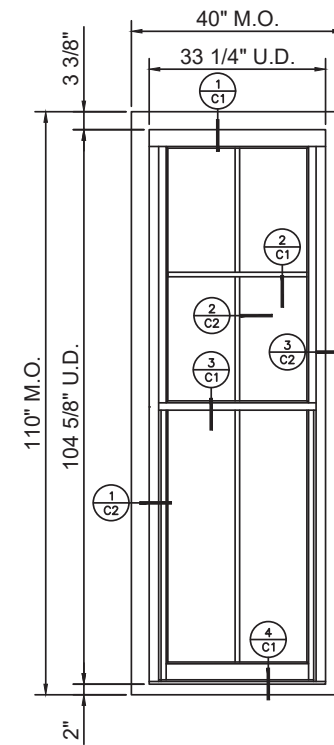

**TYPE W1A**  
 H650 SH  
 M23543 PRESET PANNING  
 QTY. 151

Project Name: **HIGGINBOTHAM SCHOOL**  
**COMPARISONS**  
**DETROIT, MI**

**CUT DETAILS**

QUAKER WINDOW PRODUCTS WILL NOT BE RESPONSIBLE FOR FIELD MEASUREMENT, QUANTITIES, & INSTALLATION DESIGN. CONTRACTOR MUST VERIFY ALL DIMENSIONS.

PHONE (573)-744-5211  
 FAX (573)-744-5586  
 dgrimm@quakerwindows.com

Scale: 1:4  
 Sheet #: C2

Drawn By: DG  
 Checked By: AGN

504 Highway 63 South  
 Freeburg, MO 65035

Drawing Created 8/11/23



EXTERIOR

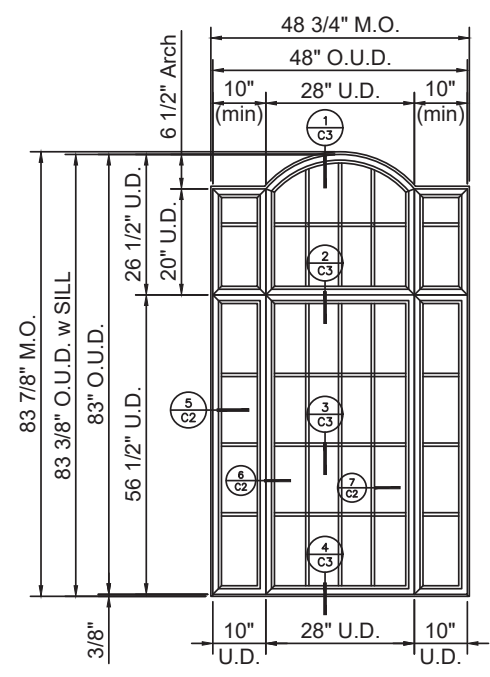
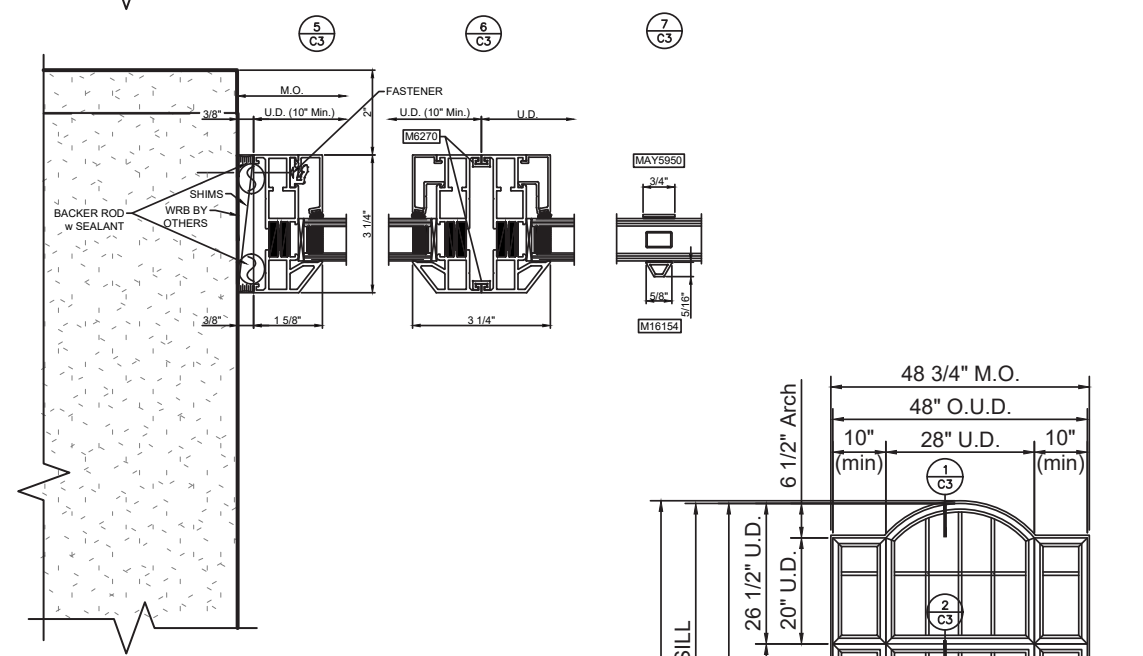
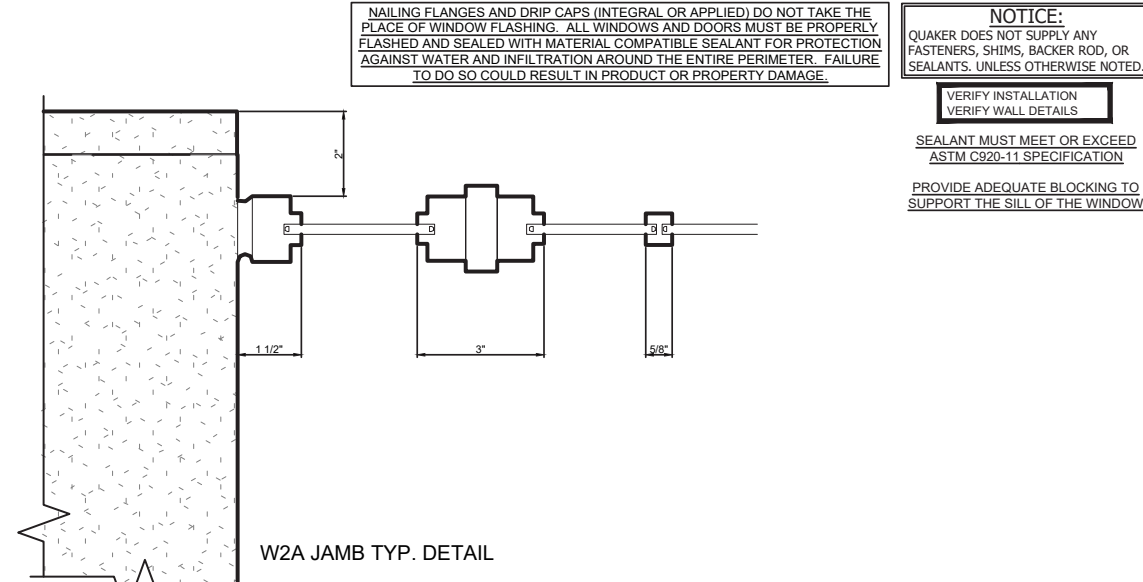
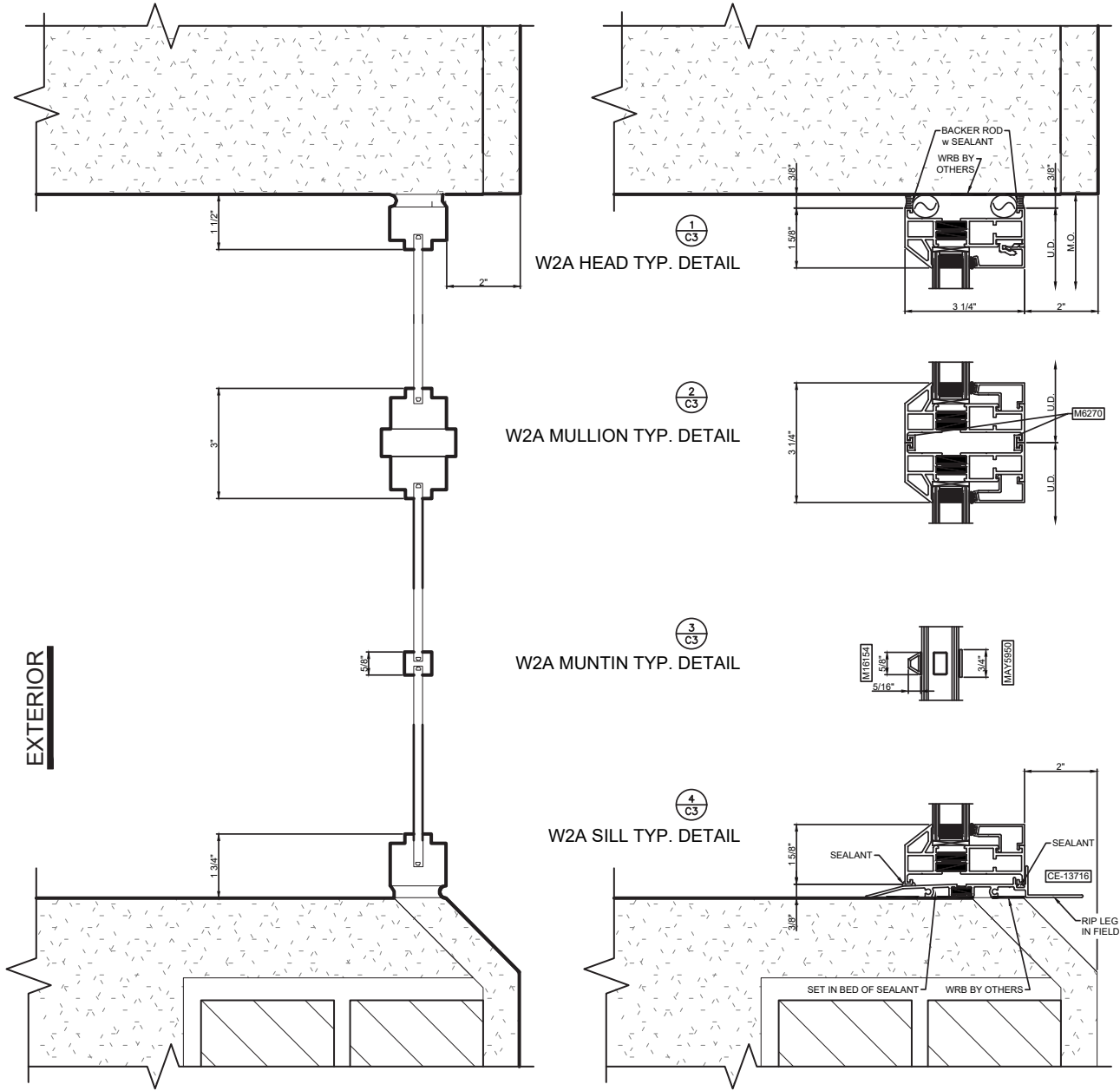

**TYPE W2A**  
H450 DS  
Horiz. & Vert. C-MULL  
QTY. 1

NAILING FLANGES AND DRIP CAPS (INTEGRAL OR APPLIED) DO NOT TAKE THE PLACE OF WINDOW FLASHING. ALL WINDOWS AND DOORS MUST BE PROPERLY FLASHED AND SEALED WITH MATERIAL COMPATIBLE SEALANT FOR PROTECTION AGAINST WATER AND INFILTRATION AROUND THE ENTIRE PERIMETER. FAILURE TO DO SO COULD RESULT IN PRODUCT OR PROPERTY DAMAGE.

**NOTICE:**  
QUAKER DOES NOT SUPPLY ANY FASTENERS, SHIMS, BACKER ROD, OR SEALANTS, UNLESS OTHERWISE NOTED.

VERIFY INSTALLATION  
VERIFY WALL DETAILS

SEALANT MUST MEET OR EXCEED  
ASTM C920-11 SPECIFICATION

PROVIDE ADEQUATE BLOCKING TO  
SUPPORT THE SILL OF THE WINDOW

Project Name: **HIGGINBOTHAM SCHOOL**  
**COMPARISONS**  
**DETROIT, MI**

**CUT DETAILS**

Description: QUAKER WINDOW PRODUCTS WILL NOT BE RESPONSIBLE FOR FIELD MEASUREMENT, QUANTITIES, & INSTALLATION DESIGN. CONTRACTOR MUST VERIFY ALL DIMENSIONS.

**QUAKER**  
COMMERCIAL

PHONE (573)-744-5211  
FAX (573)-744-5586  
dgrimm@quakerwindows.com

Drawn By: DG  
Checked By: AGN

Scale: 1:4  
Sheet # C3

504 Highway 63 South  
Freeburg, MO 65035

Drawing Created 8/11/23





# SL-18 6-Panel Wood Grain

## FRP/ALUMINUM HYBRID DOOR

### Classic 6-Panel Doors Designed to Meet the Aesthetic Considerations of Georgian & Colonial Style Architecture

Special-Lite® SL-18 Colonial Wood Grain Doors combine traditional styling with the advantages of modern engineering and materials to deliver high performance and long life. They feature a remarkable fiberglass face sheet material that offers the attractive a of wood, with all the advantages of fiberglass.

#### Features & Benefits

##### Aluminum chassis with proven flexural strength

- Manufactured with stiles and rails of extruded 6063-T6 aluminum alloy
- Stiles and rails are joined with mitered corners and angle blocks secured by 3/8" diameter full-width galvanized steel tie rods
- All anodized finishes are Class I (.7mil)
- Standard and Optional internal reinforcements provide secure attachment for the exact hardware specified

##### Fiberglass wood grain face sheet

- Face sheets are rabbeted and secured on all four sides by full-length integral reglets on the edges of the stiles and rails to form a truly flush door
- SL-18 face sheets are .120" thick, authentic oak species wood grain replication FRP, similar to our SL-19 door. Unlike wood doors, the fiberglass will never warp, split, peel or rot
- You can achieve the rich look of real stained wood with our selection of six natural wood stain colors, painted to match any of our available Kynar 500®, or any painted color\*
- Made-to-order sizes from a minimum of 30" x 80" to a maximum of 48" x 96"

##### Core has great thermal performance

- Poured-in-place closed cell polyurethane foam core that is a minimum of 5 LB./cubic foot density

##### Fiberglass wood grain face sheet

- Doors can be supplied with hardware installed, reinforced only, or prepped for field installation of hardware
- Unique configurations such as arched doors, odd sizes, unequal pairs and custom lites are no problem



\*See website product pages for color selections available. Colors are subject to change without notice.

OPTIONS FOR:



### Wood Grain FRP Accurately Captures the Natural Grain Characteristics

Beautiful look of natural oak wood manufactured into a long lasting, low maintenance fiberglass door. The fiberglass surface offers a degree of resistance to stains, scuffs and impacts that would easily damage wood. It's also resistant to the elements and corrosive environments - even coastal salt spray - and offers excellent cleanability.

### At the Core of our Door's Strength is our Door's Core

The poured-in-place closed cell polyurethane foam core of our SL-18 is not just a passive filler - it's a functional component that contributes significantly to the durability of Special-Lite® Doors. After the door has been completely assembled, the core material is injected using our proprietary foam injection technology, ensuring a complete fill with a minimum five pounds per cubic foot density. This strong, lightweight, structural closed cell polyurethane foam bonds firmly to the rails, stiles, reinforcements and face sheets to transform the door into a solid, completely sealed unit with incredible impact resistance and flexural strength. Our closed cell polyurethane foam won't absorb or be damaged by water, and offers great thermal properties.

### Building Applications

Whether for new construction or historic preservation projects, an investment in our colonial wood grain doors will pay dividends in attractiveness and durability for years to come. They are durable enough for even high traffic entrances in education, religious, retail and municipal facilities that call for the classic appearance of a wood door.

### Color Selections

The FRP/Aluminum Hybrid Doors have two color decisions that must be made: aluminum chassis and face sheet. Aluminum chassis can be anodized or painted. Face sheets can be stained in a natural wood look, or they can be painted. See color chips, available from the online shopping cart, for final color decision.

### SL-18 Door Construction

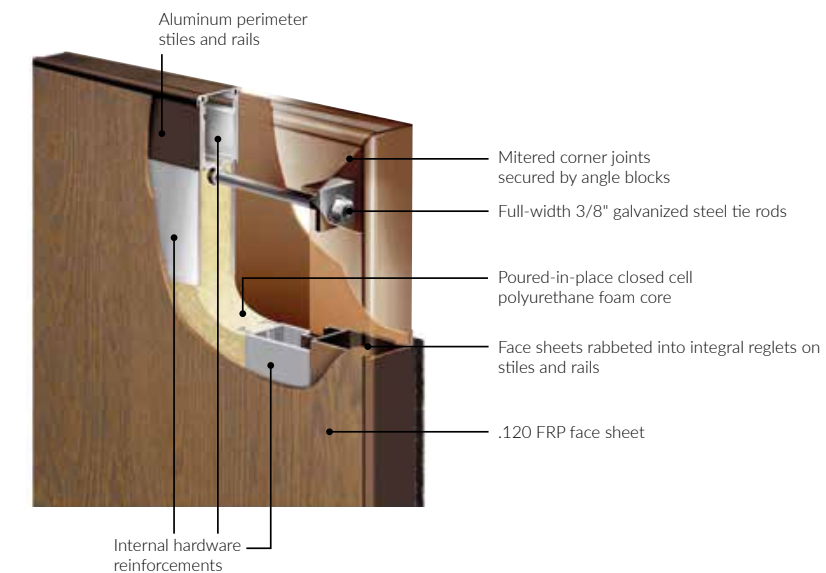

Special-Lite, Inc.  
860 S. Williams St. Decatur, MI 49045

special-lite.com 800.821.6531 Item 1240-R1 08/20 PDF





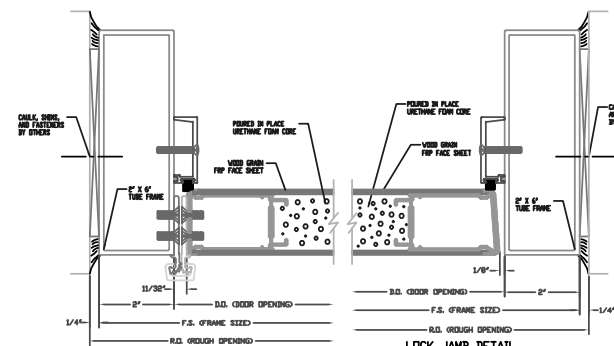

CONTINUOUS HINGE JAMB DETAIL

LOCK JAMB DETAIL

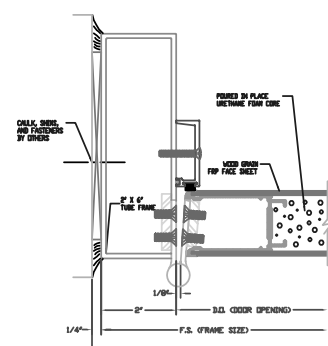

BUTT HINGE JAMB DETAIL

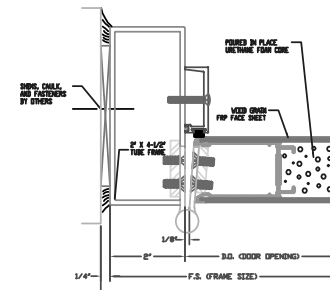

BUTT HINGE JAMB DETAIL

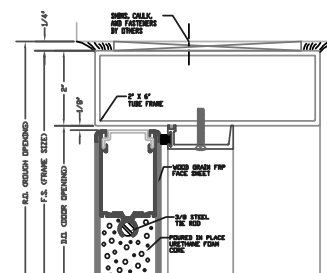

HEAD DETAIL

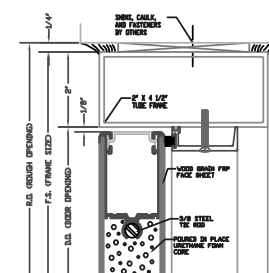

HEAD DETAIL

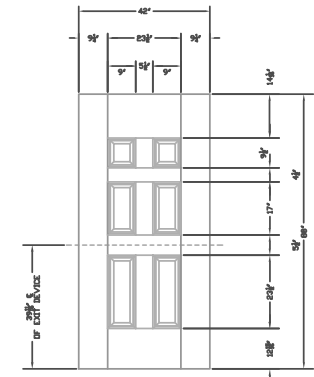
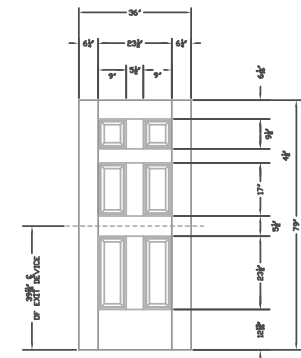

PATTERN 336A  
MIN= 3'- 0" x 6'- 8"  
MAX= 3'- 6" x 7'- 4"

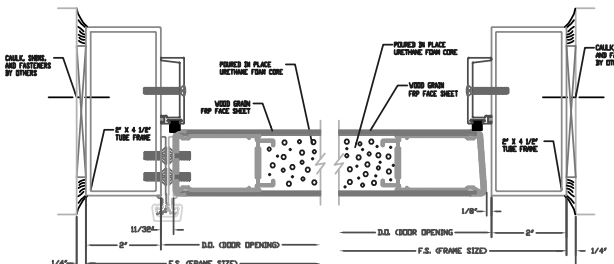

CONTINUOUS HINGE JAMB DETAIL

LOCK JAMB DETAIL

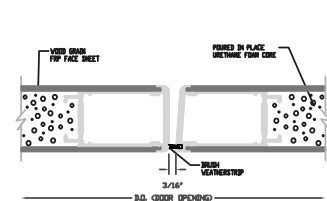

MEETING STILES MORTISE LOCK

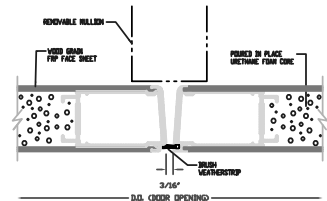

MEETING STILES RIM PANICS (STANDARD)

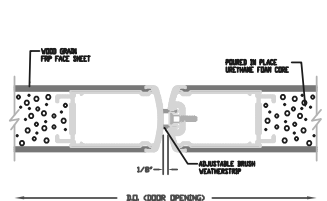

MEETING STILES (OPTIONAL)

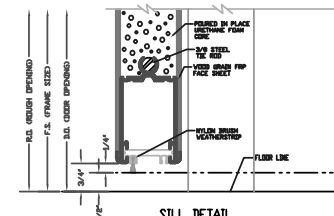

SILL DETAIL

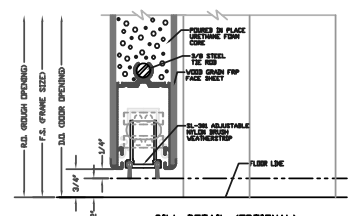

SILL DETAIL (OPTIONAL)

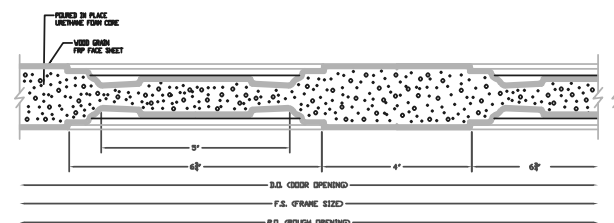

RAISED PANEL HORIZONTAL DETAIL

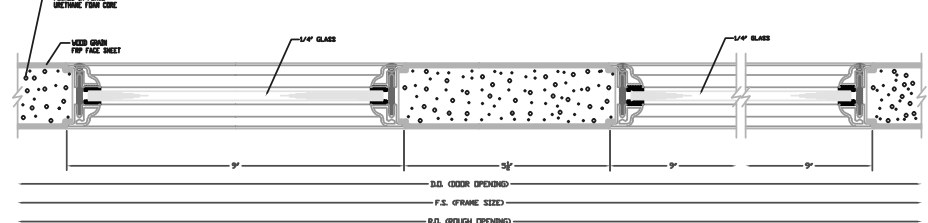
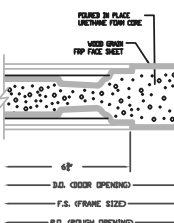

OPTIONAL 1/4\"/>

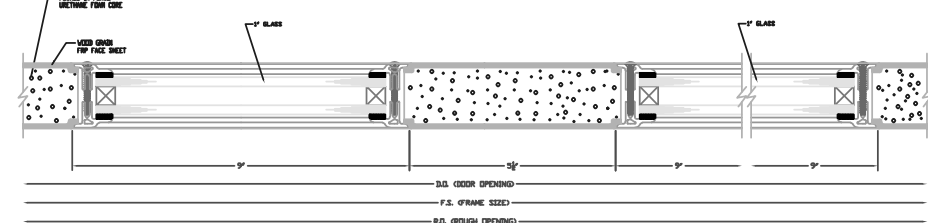

OPTIONAL 1\"/>

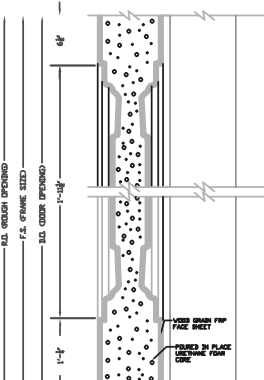

RAISED BOTTOM PANEL DETAIL

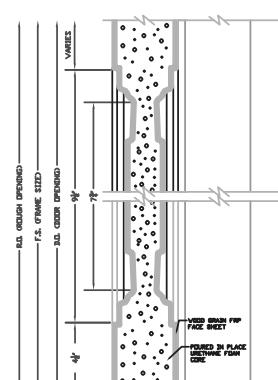

RAISED TOP-PANEL DETAIL

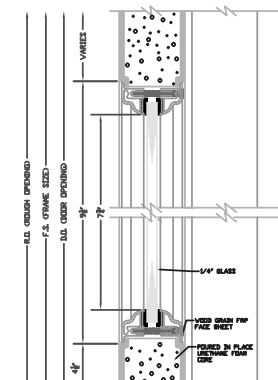

OPTIONAL TOP 1/4\"/>

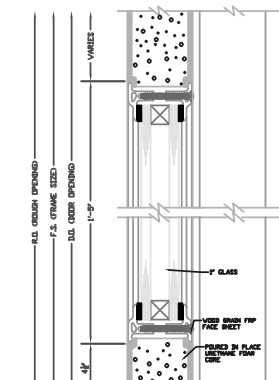

OPTIONAL TOP 1\"/>

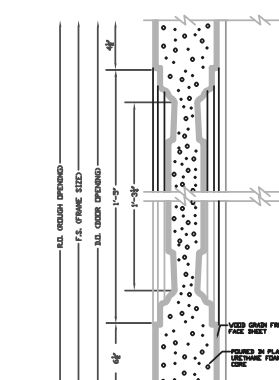

RAISED MID-PANEL DETAIL

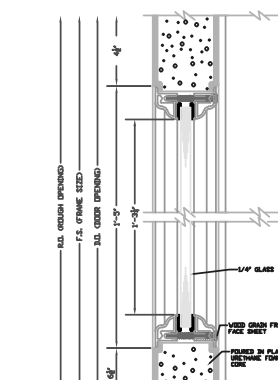

OPTIONAL MID 1/4\"/>

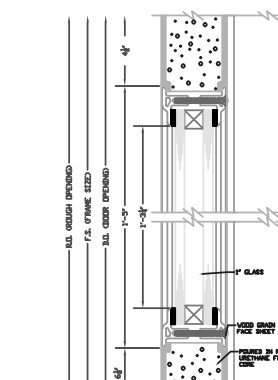

OPTIONAL MID 1\"/>

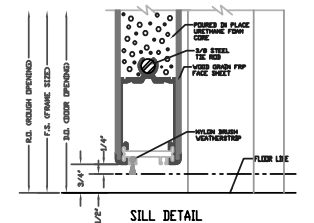

SILL DETAIL

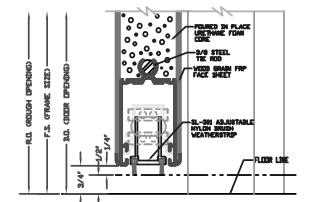

SILL DETAIL (OPTIONAL)

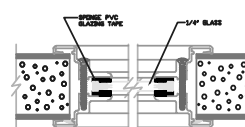

1/4\"/>

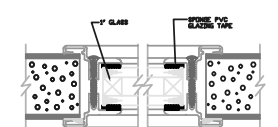

1\"/>

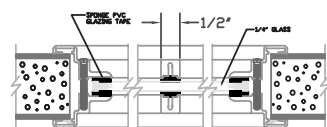

1/4\"/>

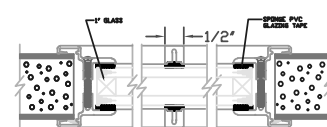

1\"/>

		<b>SPECIAL-LITE, INC.</b> 860 South Williams Street P.O. BOX 6 DECATUR, MI 48045 WWW.SPECIAL-LITE.COM	
		DRAWN BY: BAS REVISION:	SL-18 FRP FLUSH COLONIAL DOOR
A 4/3/17 B 1/9/19	C 11/1/21 D 10/21/22	FILE: SL18DETAILS.dwg	



Project: \_\_\_\_\_  
 Fixture Type: \_\_\_\_\_  
 Location: \_\_\_\_\_  
 Contact: \_\_\_\_\_

### Z-2020 LED

Ceiling Mounted • Wet Location Listed **PROGRESS LED**

#### Description:

Z-2020 LED Collection 1-Light Satin White Frosted Glass LED Modern Circle Wall Light

#### Specifications:

- Frosted Glass Cylindrical
- Dimmable to 10% brightness (See Dimming Notes)
- Canopy covers a standard 4" recessed outlet box: 4.75 in W, 0.75 in ht., 4.75 in depth
- Mounting strap for outlet box included
- 6 in of wire supplied
- Americans With Disabilities Act (ADA) compliant

#### Performance:

Number of Modules	1
Input Power	9 W
Input Voltage	120 V
Input Frequency	60 Hz
Lumens/LPW (Source)	670/71 (LM-82)
CCT	3000 K
CRI	90 CRI
Life (hours)	60000 (L70/TM-21)
EMI/RFI	FCC Title 47, Part 15, Class B
Warranty	5-year Limited Warranty
Labels	cCSAus Wet Location Listed ENERGY STAR® qualified Meets California Title 24 JA8-2016

## P560260-028-30



#### Dimensions:

Length: 6-1/4 in  
 Extends: 2-1/4 in  
 Height: 2-1/4 in

Frosted Glass Cylindrical  
 Width: 1-1/4 in  
 Height: 4-3/4 in

701 Millennium Blvd. Greenville, South Carolina 29607

www.progresslighting.com

Rev. 11/20

## BULLETO LINE

Compact Adjustable Floodlight Projector

LF-5



BULLETO LINE shown in Ferrite Dark Grey finish.

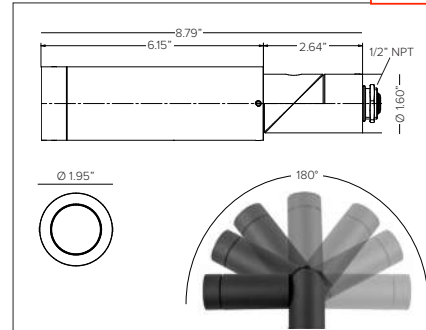

#### CONCEPT

Compact projector flood light for high intensity applications.

#### MECHANICAL CHARACTERISTICS

<b>Housing</b>	1.95" W x 8.79" D
<b>Materials</b>	Aluminum body and joints for maximum heat dissipation.
<b>Finish</b>	Textured finish. ● Ferrite Dark Grey ● Heritage Brown ● Bronze ● Black ● White ● Sandstone Grey
<b>Power Connection</b>	Pre-cabled with 10' Belden direct burial 18-6 cable, optional 25ft length for pole mounting.
<b>Functionality</b>	Modular body for toolless maintenance. IP66 protection rated optical chamber with removable front cap for simple toolless field interchangeability of optics and accessories.
<b>Mounting</b>	Adjustable up to 180° on the vertical surface with aim lock set screw, 360° rotatable on the horizontal axis. Brass counter nut with 1/2" NPS mounting stem suitable for direct-j-box mount. Optional installation accessories for additional mountings.
<b>Weight</b>	2lbs
<b>Protection</b>	IP66
<b>Impact</b>	IK08

#### CERTIFICATIONS

cULus Wet Location Listed E479673.  
 Tested in accordance with LM-79-08.  
 Compliant for California installations.  
 IEC 62471  
 RoHS3 EU 215/863

#### WARRANTY

5 year limited warranty  
 \* Fixture suitable for use in marine grade environments. Not to be in direct contact with salt or corrosive agents for extended periods of time.

#### SUSTAINABILITY

Luminaire designed for disposal/recycling at end-of-life. Replaceable LED light source and control gear by a Targetti technician.

#### ELECTRICAL CHARACTERISTICS

<b>Power Supply</b>	Integral 4/1 smart driver (Non-Dimmable / 0-10V / Reverse Phase / Forward Phase).
<b>Wattage</b>	9W (NSP) / 17W (SP/FL/MFL/WFL)
<b>Voltage</b>	Universal Voltage 120-277V AC 50/60Hz

#### SOURCE

High efficiency LED Emitter

TM30	CCT (Nominal)	CRI	Rf	Rg	SDCM
2700K	90	88	95	2	
3000K	90	91	98	2	
3500K	90	89	96	2	
4000K	90	88	94	2	

#### OPTIC

Optical system is dependent on beam angle. NSP version PMMA lens and fixed holographic filter. SP / FL / MWFL / WFL versions equipped with PMMA lens and interchangeable optical holographic lens, factory preset per specified optic with other beams included in packaging.

Beam	NSP 9°	SP 16°	FL 25°	MWFL 31°	WFL 42°
<b>Delivered Lumens</b>	2700K 407Lm	1008Lm	979Lm	930Lm	764Lm
3000K	430Lm	1085Lm	1054Lm	1001Lm	823Lm
3500K	445Lm	1119Lm	1088Lm	1033Lm	849Lm
4000K	460Lm	1153Lm	1120Lm	1063Lm	874Lm

**Efficacy** 70Lm/W max. Refer to photometric graphs for specific values.

<b>Lifetime</b>	L96/B10 30,000hrs at max TA +25°C L95/B10 50,000hrs at max TA +25°C L94/B10 80,000hrs at max TA +25°C L93/B10 100,000hrs at max TA +25°C
-----------------	---

**Photobiological Classification** Low risk safety RGI

## BOWMAN 6 WALL SCONCE



The classic silhouette of this sleek LED wall sconce makes it suitable for both indoor and outdoor applications. The Bowman's die-cast aluminum body houses a powerful, long-lasting LED light source tightly controlled for down light only, yet supplying significant illumination for even the darkest nights.

**High quality LM80-tested LEDs**  
 for consistent long-life performance and color

#### Outstanding protection against the elements:

- Marine-grade powder coat finishes
- Stainless Steel mounting hardware
- Impact-resistant, UV stabilized frosted acrylic lensing

#### SPECIFICATIONS

DELIVERED LUMENS	1163
WATTS	47.2
VOLTAGE	120V, 277V
DIMMING	ELV
LIGHT DISTRIBUTION	Symmetric
MOUNTING OPTIONS	Downlight
CCT	2700K**, 3000K
CRI	80+
COLOR BINNING	3 Step
BUG RATING	B1-U0-G0
DARK SKY	Compliant
WET LISTED	IP65
GENERAL LISTING	ETL
CALIFORNIA TITLE 24	Can be used to comply with CEC 2016 Title 24 Part 6 for outdoor use. Registration with CEC Appliance Database not required.
START TEMP	-30°C
FIELD SERVICEABLE LED	No
CONSTRUCTION	Aluminum
HARDWARE	Stainless Steel
FINISH	Marine Grade Powder Coat
LED LIFETIME	L70; 70,000 Hours
WARRANTY*	5 Years
WEIGHT	3.2 lbs.

\* Visit techlighting.com for specific warranty limitations and details.  
 \*\* Available in Black and Bronze finish only.

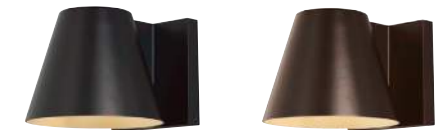

BOWMAN 6 shown in black

BOWMAN 6 shown in bronze



BOWMAN 6 shown in charcoal

BOWMAN 6 shown in silver



BOWMAN 6 shown in white

#### ORDERING INFORMATION

700WSBOW	LENGTH	FINISH	LAMP
6 6"	B	BLACK	-LED827 LED 80 CRI, 2700K 120V**
	Z	BRONZE	-LED827Z77 LED 80 CRI, 2700K 277V**
	H	CHARCOAL	-LED830 LED 80 CRI, 3000K 120V
	I	SILVER	-LED830Z77 LED 80 CRI, 3000K 277V
	W	WHITE	

\*AVAILABLE IN BLACK AND BRONZE FINISH ONLY

techlighting.com



# TOTAL BUILDING DATA: GARDEN APTS.

	COUNT	NET AREA
STUDIO	24	12,240 SF
1 BEDROOM	24	14,400 SF
2 BEDROOM	12	11,900 SF
<b>TOTALS</b>	<b>60</b>	
<b>NET RENTABLE (RESIDENTIAL)</b>		<b>38,540 SF</b>
<b>GROSS</b>		<b>45,410 SF</b>
<b>EFFICIENCY</b>		<b>85%</b>



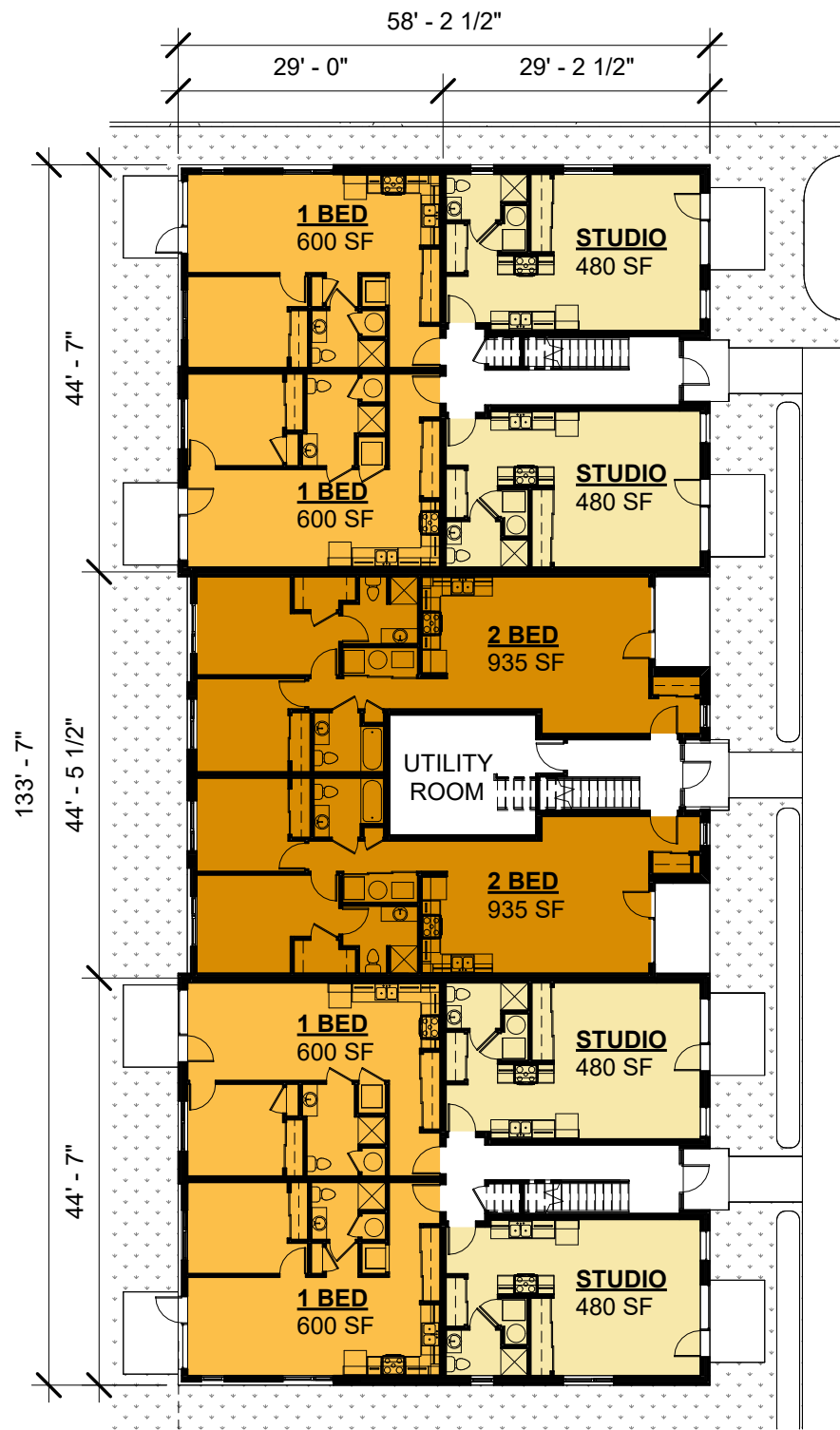

**GROUND FLOOR**

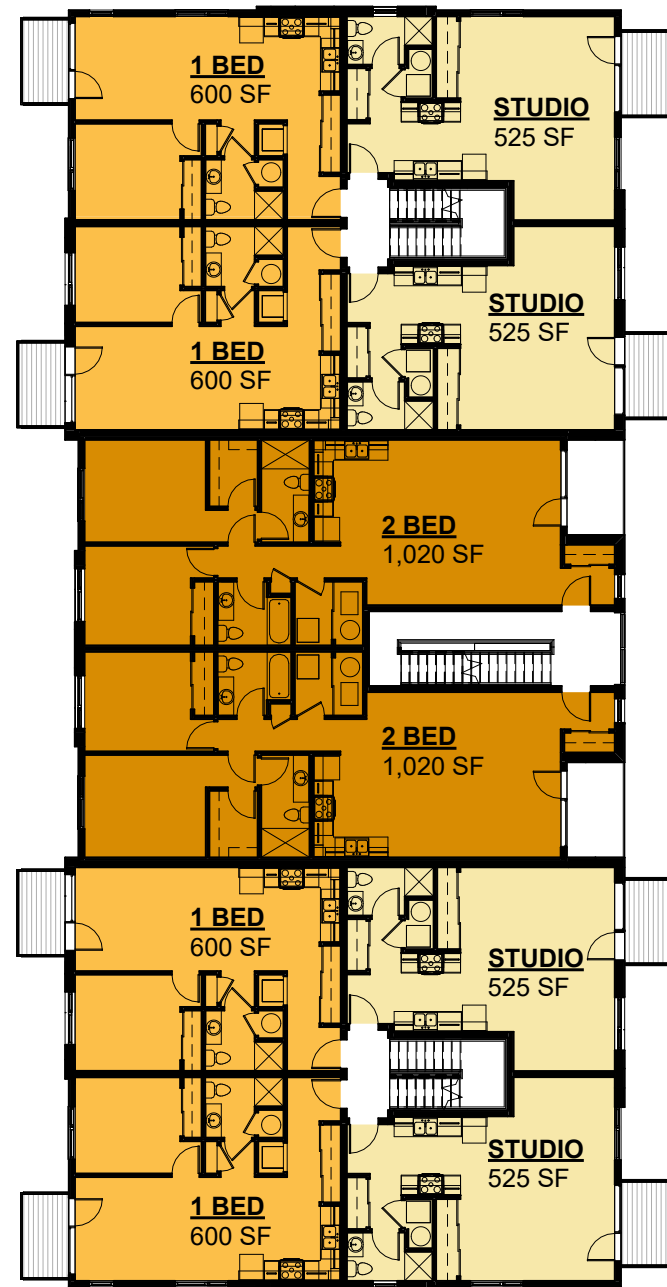

**SECOND FLOOR**

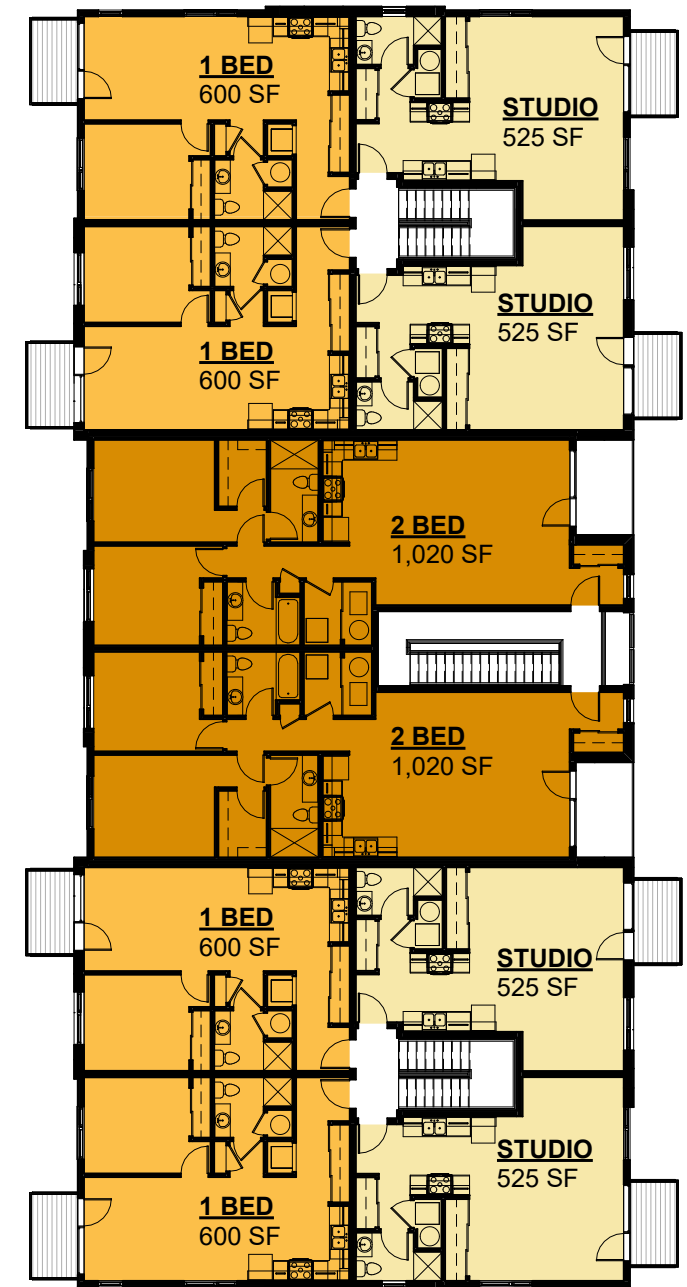

**THIRD FLOOR**



# EXISTING

PRIMARY BRICK

ACCENT BRICK

WINDOW & DOOR COLOR

ROOFING

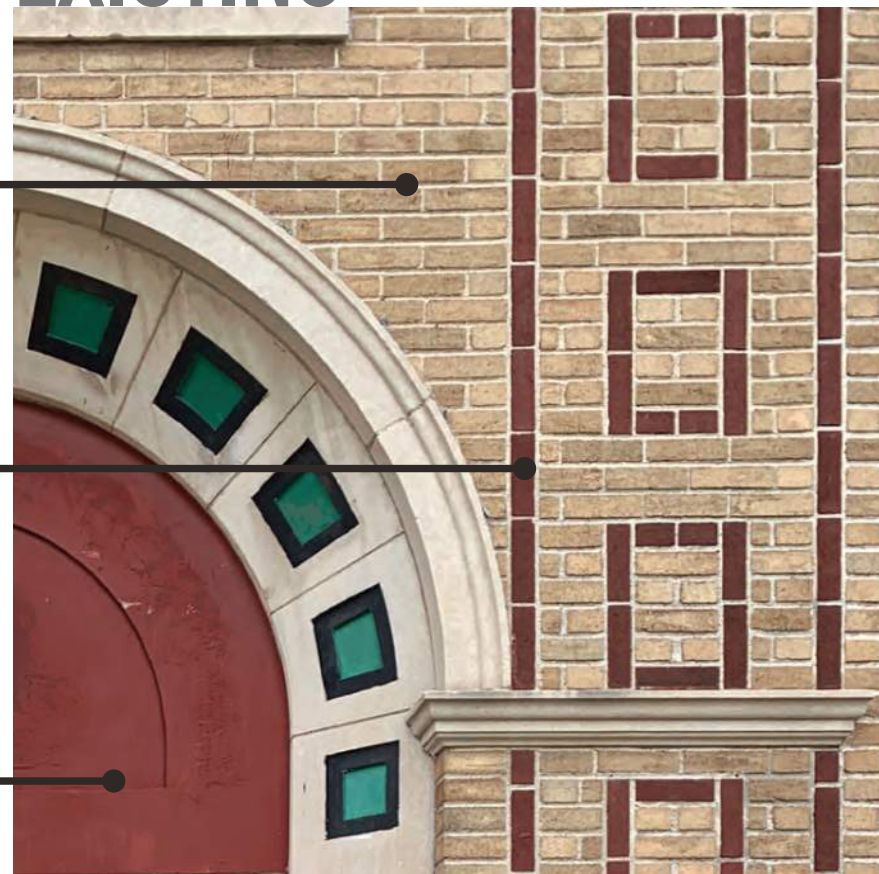

# PROPOSED

BRICK



VERTICAL SIDING



CEMENT PANEL

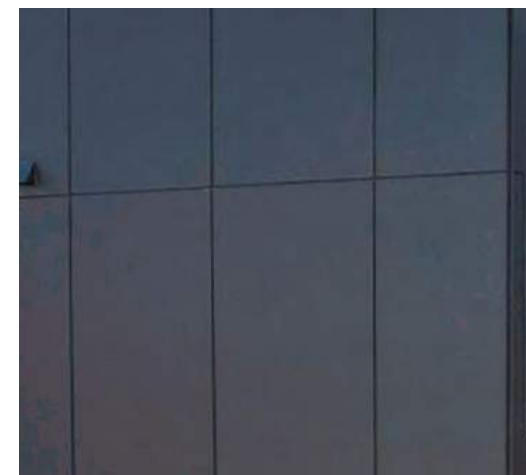

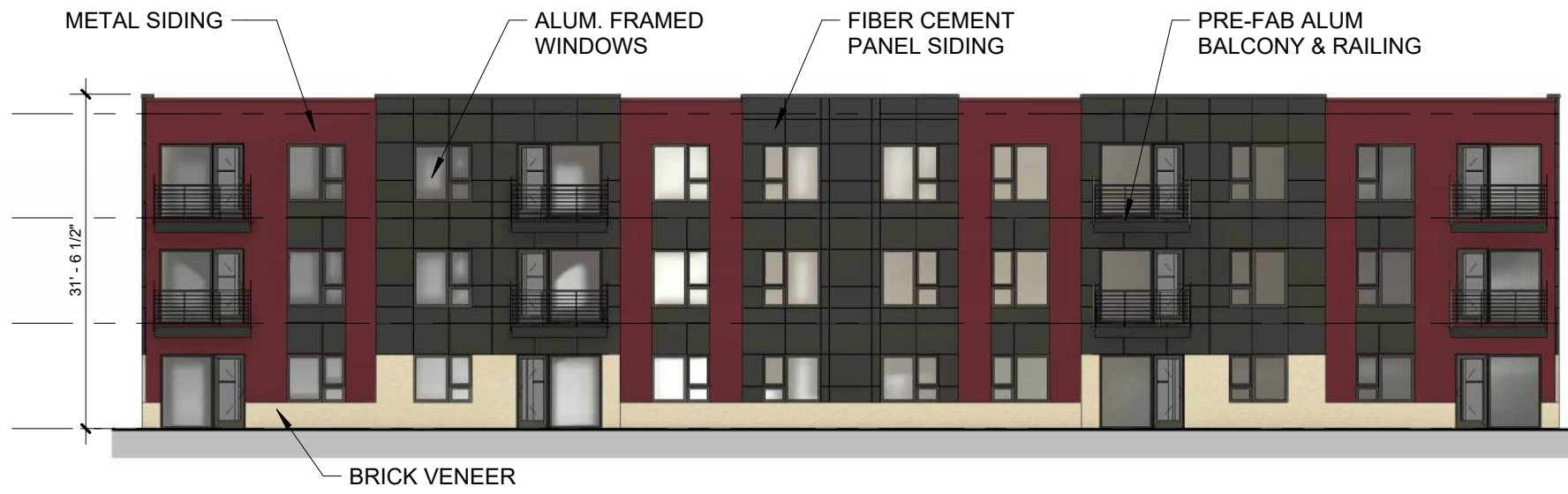

**STREET ELEVATION**



**SIDE ELEVATION**

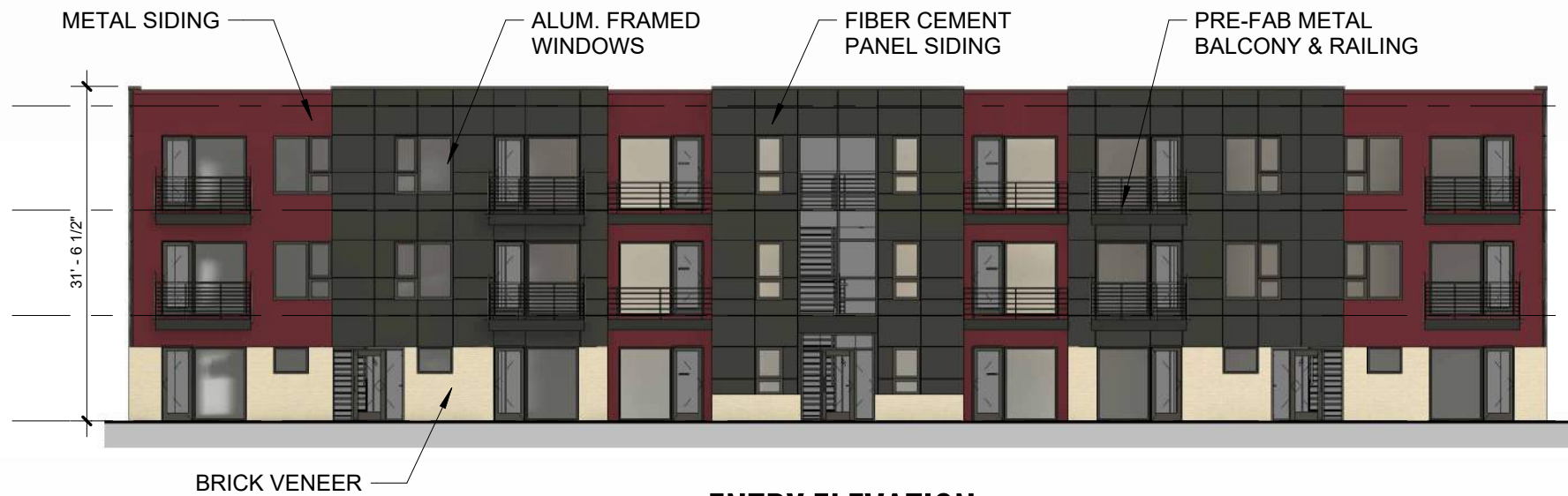

**ENTRY ELEVATION**



**SIDE ELEVATION**



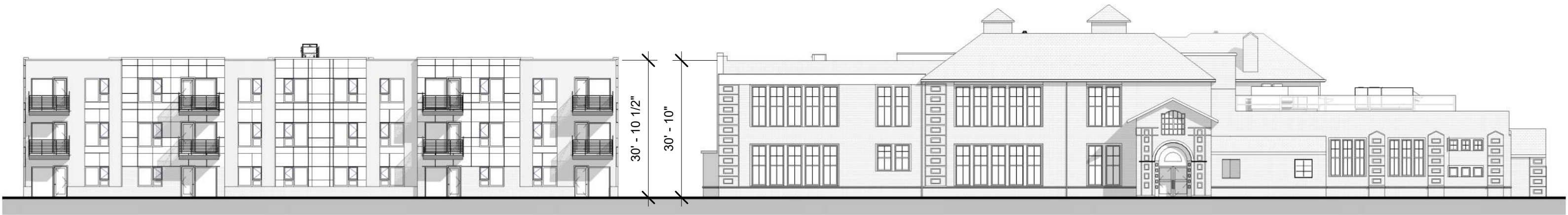





Aerial view looking Northwest





View from Chippewa





View from Indiana





View from parking lot





View of the mews looking North





View of Courtyard





Looking east from Indiana



Looking north from Chippewa