

# DHDC 22-7799

## APPROVAL DOCUMENT - POST AT WORK LOCATION



CITY OF DETROIT  
HISTORIC DISTRICT COMMISSION

2 WOODWARD, SUITE 808  
DETROIT, MICHIGAN 48226

May 18, 2022

### CERTIFICATE OF APPROPRIATENESS

Kevin Prihod  
605 Chicago Avenue  
Detroit MI 48202

**RE: Application Number 22-7799; 605 Chicago; Boston-Edison Historic District**

Dear Mr. Prihod,

At the Regular Meeting that was held on May 11, 2022, the Detroit Historic District Commission (“DHDC”) reviewed the above-referenced application. Pursuant to Section 5(1) of the Michigan Local Historic District Act, as amended, being MCL 399.205 (1) and Sections 21-2-73/21-2-78 of the 2019 Detroit City Code; the DHDC hereby issues a Certificate of Appropriateness (“COA”) for the following work, effective on May 17, 2022, as it meets the Secretary of Interior’s Standards for Rehabilitation and the district’s Elements of Design:

***Erect of a one-story addition at the west elevation near the rear elevation, per the submitted documents, drawings, and product data.***

***With the condition that:***

- ***The drawings will be revised to address the following issues: removal of square vents and specification of tile ridge vents, visual confirmation that the roof ridge will terminate below the second story stone trim, correction of window color, trim specification, and muntin profile.***

Please retain this COA for your files and post it at the subject property until work is complete. It is important to note that approval by the DHDC does not waive the applicant's responsibility to comply with any other applicable ordinances or statutes. If you have any questions regarding the foregoing, please contact staff at 313-224-1762 or [hdc@detroitmi.gov](mailto:hdc@detroitmi.gov).

For the Commission:

Audra Dye  
Detroit Historic District Commission

## Proposed Additions to 605 Chicago Boulevard

Homeowners: Kevin Prihod & Mary Zatina since 1982

1. Bump out of portion of west wall at southwest corner of the house
2. One story addition – 22'3" x 14'8 ½"
3. Wood frame with matching brick (Sioux City Fine Art Velour)
4. Limestone banding matching existing banding
5. Lodowici Red Clay French Interlocking tile roofing
6. Anderson Series 400 Woodwright Windows
7. Addition to allow for expansion of existing kitchen
8. West wall of addition set back 8'3" from property line
9. Architect: Scott Wright of D.S. Wright & Associates
10. 5" troughs and downspouts Identical to existing structure
11. Mini-Split HVAC system attached low on new north wall
12. Fascia and exterior casing identical in size and color to existing trim

Addition allows for expansion fo Existing kitchen without having to make historically inappropriate changes to interior layout.

3/30/22

**REVIEW & FILE**  
**SUBMIT COMPLETE APPLICATION TO HDC STAFF**

Corrected application

**CHICAGO BLVD.**  
(125' Wide)

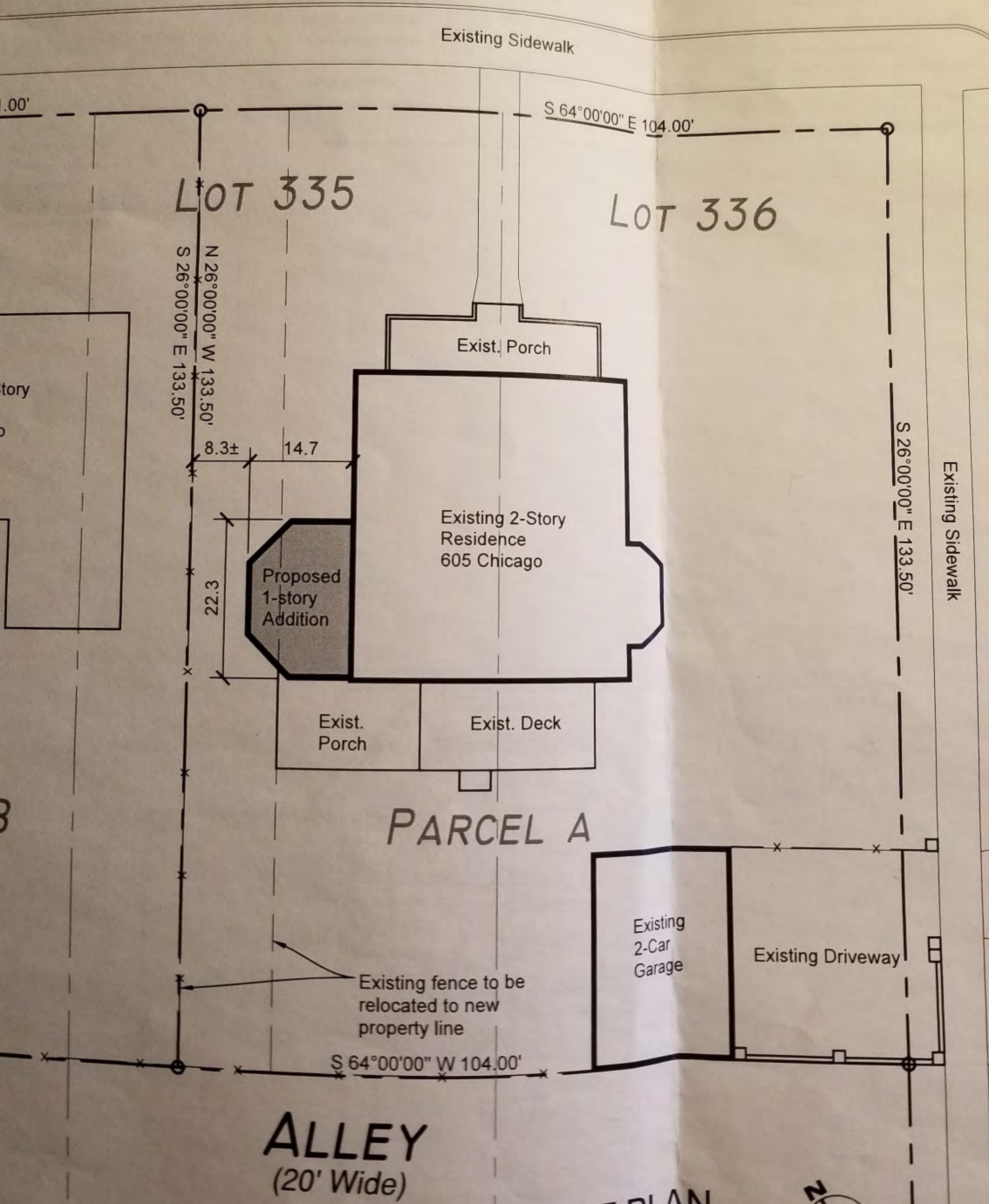

**PARCEL A**

**ALLEY**  
(20' Wide)

**PLOT PLAN**  
SCALE: 1"=20'-0"

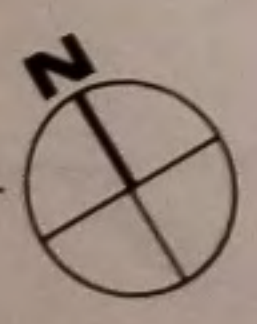

















**FOUNDATION NOTES:**

The building area shall be cleared of debris, topsoil, and organic material. Any existing fill shall be removed and replaced. New fill material shall be clean, well-graded granular material and placed in lifts of not more than 9", with each lift being compacted to a minimum of 95% of the maximum dry density as determined by ASTM designation D-1557 (Modified Proctor).

Concrete for foundations and slab on grade shall have minimum compressive strengths of 3,000 p.s.i. in 28 days. Minimum cement contents shall be 5.5 bags per yard. Air entrainment shall be used for concrete exposed to weather.

Reinforcing steel shall be deformed bars with yield strengths in accordance with A.S.T.M. A-615 grade 60. Welded wire fabric (mesh) shall conform to A.S.T.M. A-185 with minimum side and end laps of 8".

All reinforcing shall be fabricated and placed according to the "Manual of Std. Practice for Detailing Reinforced Concrete", A.C.I. 318-65 revised. Bends, splices and cover shall be in accordance with A.C.I. 318-77.

All foundations shall bear at depths shown or as recommended by a soils engineer. Bearing shall be in compacted virgin undisturbed soil with a minimum bearing capacity of 2,000 p.s.i. Compaction of the existing soil shall be in accordance with the recommendation of the soils engineer and shall be verified prior to placing concrete.

**MASONRY NOTES:**

All work shall conform to the "American Standard Building Code Requirements for Masonry", U.S. Department of Commerce National Bureau of Standards Miscellaneous Publication 211 (American Standards Association A41.1).

Provide 8" solid masonry under ends of walls bearing beams, joists and lintels unless noted otherwise.

All block masonry work below grade shall be 8" or 12" thick concrete block masonry filled with 3,000 PSI concrete with pea gravel aggregate.

**WOOD FRAMING:**

Stud Framing:

General: Provide stud framing where shown. Use 2" x 4" or 2"x6" wood studs 16" o.c. for exterior and bearing walls as shown; for other interior partitions, use 2" x 4" wood studs spaced 16" o.c. Provide single bottom plate and double top plate and double-top plates 2" thick by width of studs, except for anchor plates to supporting construction. Construct corners and intersections with not less than 3 studs; anchor to abutting masonry or concrete, if any. Provide miscellaneous blockings and framing as shown and as required for support of facing materials, fixtures, specialty items and trim.

Joist Framing:

General: Provide framing of sizes and on spacing shown. Support ends of each member with not less than 1-1/2" of bearing on wood or metal or 3" on masonry. Attach to wood bearing members by toe nailing or metal connectors; frame to wood supporting members with wood ledgers, or with metal connectors. Frame openings with headers and trimmers supported by metal joist hangers; double headers and trimmers where span of header exceeds four feet. Do not notch in middle third of joists; limit notches to not more than 1/6 depth of joist or locate closer than 2" from top or bottom. Provide alternate solid blocking (2" thick by depth of joist) at ends of joist unless nailed to header or band member.

Provide bridging between joists whose nominal depth-to-thickness ratio exceeds 5, at intervals of 8 feet. Use bevel cut 1" x 4" or 2" x 3" wood bracing, double-crossed and nailed both ends to joists.

**LUMBER SPECIFICATIONS:**

USAGE/ LOCATION VALUES (psi)	SIZE CLASSIFICATION	MATERIAL	DESIGN
Misc. Framing	2"x4" or 2"x6" studs	Hem-Fir #2 or better	Fb = 850 (S) Ft = 625 Fv = 150
Walls, Partitions, Joists	2"x12" joists		Fc+ = 405 Fc = 1,300 E = 1,200,000
Beams	2"x8"		

**SELECTIONS OF THE FOLLOWING MATERIALS, EQUIPMENT AND FIXTURES ARE TO BE MADE BY THE OWNER / DEVELOPER.**

**INSTALLATION IS TO BE IN ACCORDANCE WITH LOCAL CODES AND MANUFACTURER'S WRITTEN INSTRUCTIONS.**

. Window type, other than specified product and installation details.

. Exterior brick, to match existing, and block.

. Exterior siding and trim.

. Exact type of gutters and downspouts. Coordinate location of downspouts with the Owner.

. Sealant type and color.

. Floor finishes.

. Wall & ceiling finishes other drywall.

. Paint materials.

. Interior door and frame details.

. Kitchen and vanity cabinets type and detail.

. Plumbing fixtures.

. Electrical devices and light fixtures.

. HVAC equipment and systems.

**ELECTRICAL LEGEND**

⊕	15A 115V DUPLEX RECEPTACLE	⊕	HARD WIRED, INTERCONNECTED COMBINATION SMOKE & CARBON MONOXIDE DETECTOR
⊕ <sub>WP</sub>	15A 115V DUPLEX RECEPTACLE IN WEATHER PROOF BOX	⊕	WALL MOUNTED LIGHT FIXTURE
⊕ <sub>GFCI</sub>	15A 115V GROUND FAULT CIRCUIT INTERRUPTER RECEPT.	⊕	CEILING RECESSED CAN LIGHT FIXTURE
⊕	30A 220V APPLIANCE RECEPTACLE	⊕	CEILING MOUNTED LIGHT FIXTURE
△	CAT3 TELEPHONE OUTLET	⊕	KEYLESS LAMP HOLDER w/ PULL CHAIN
\$	15A SINGLE POLE SWITCH	⊕	CEILING FAN
\$	15A 3-WAY SWITCH	⊕	120V CEILING MOUNTED EXHAUST FAN / LIGHT FIXTURE
\$	15A DIMMING SWITCH	⊕	120V CEILING MOUNTED EXHAUST FAN
⊕	JUNCTION BOX w/ 15A CIRCUIT		

**CONSTRUCTION NOTES:**

- 01 New crawl space access panel in existing window opening.
- 02 Crawl space with environmental control.
- 03 Two layers of R-7 rigid insulation board.
- 04 Polyethylene vapor barrier, cover with 1/2"-2" sand, stone or concrete slurry mix.
- 05 #5 Dowels @ 12" o.c. vertically.
- 06 New 2'-6"x6"-8" door & frame. Door to match existing doors or as selected by the Owner.
- 07 Hat shelf & pole as selected by the Owner.
- 08 New 2'-6"x6"-8" door & frame. Door to match existing doors or as selected by the Owner.
- 09 New 1/2" drywall on 2"x furring on existing studs. Thicken wall to accommodate 5/2" wide beam above.
- 10 New Andersen 400 series WoodWright double-hung window model WDH2432.
- 11 New Andersen 400 series WoodWright double-hung window model 3-WDH2432.
- 12 Relocated A/C condensing unit.
- 13 1 1/8" x 360 TJI Floor joists @ 16" o.c.
- 14 2"x Wood hip tray ceiling trusses @ 24" o.c.
- 15 Gutter and downspout.
- 16 For garbage disposer.
- 17 New fitch beam (3) 2"x8" with (2) 1/2"x7" steel plates. Beam to be flush with new and existing ceiling.
- 18 Triple stud bearing.
- 19 New Andersen 400 series WoodWright double-hung window model 2-WDH2032.

**GENERAL NOTES:**

1. All new exterior walls without brick are 7" thick unless noted otherwise.
2. All existing exterior walls with brick are 9" thick unless noted otherwise.
3. All new interior walls are 4 1/2" thick unless noted otherwise.
4. All existing interior walls are 5" thick unless noted otherwise.
5. All new door and window headers minimum (2) 2"x12".
6. Prior to the removal of any walls, verify and shore existing 2nd floor or roof structure.
7. Verify type of closet shelving and hat shelf poles with Owner.
8. \*Verify rough opening with window manufacturer.

**DEMOLITION NOTES:**

- D1 Remove and relocate existing A/C condensing unit.
- D2 Remove brick veneer and exterior sheathing.
- D3 Remove existing windows and wall.
- D4 Remove existing basement windows.
- D5 Remove existing counter top and cabinets.
- D6 Remove existing counter.
- D7 Remove existing deck steps, railings, balusters, and posts. Save railing, balusters, and posts for reuse.
- D8 Shorten existing downspouts and spill on new roof.

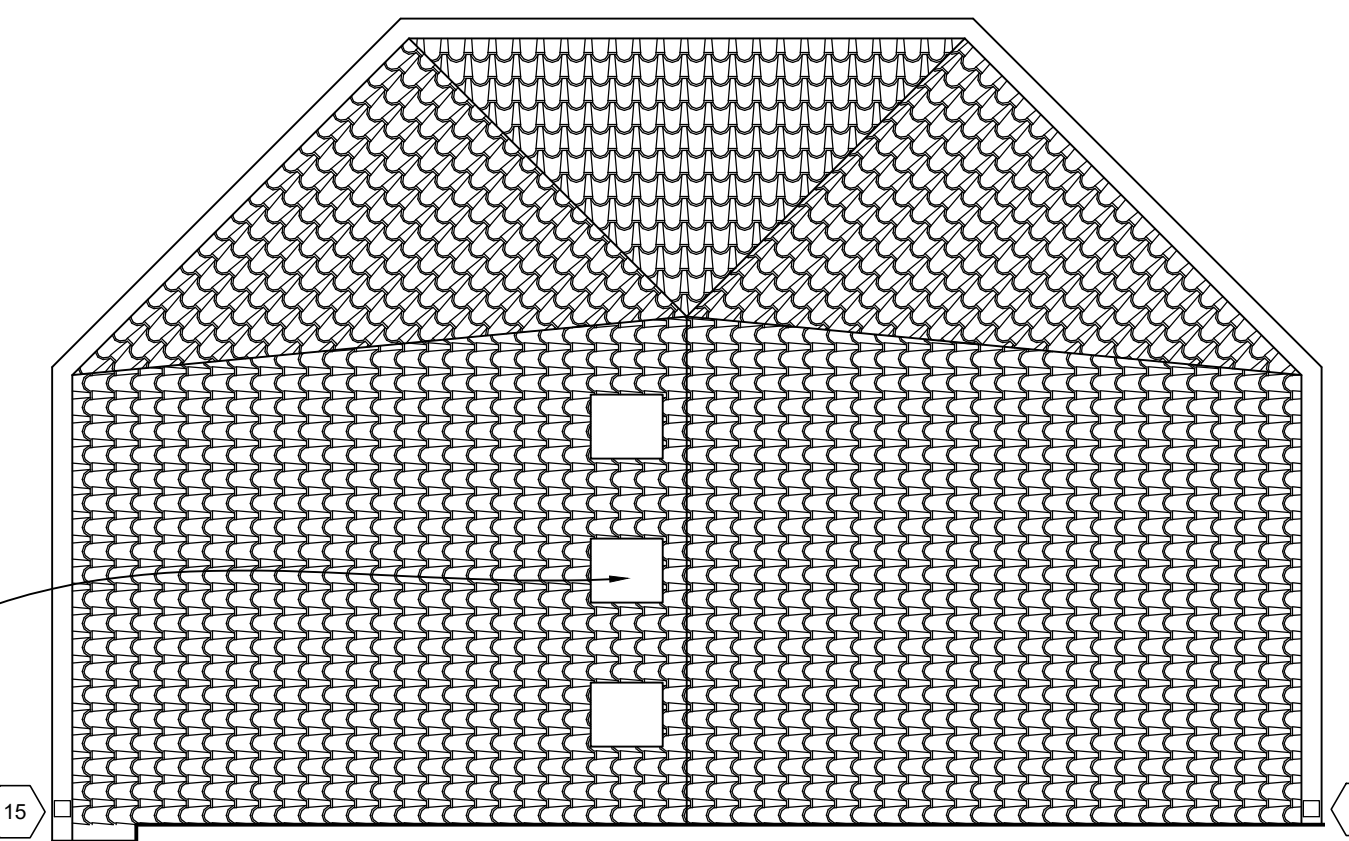

**Roof Plan**

Scale: 1/4"=1'-0"

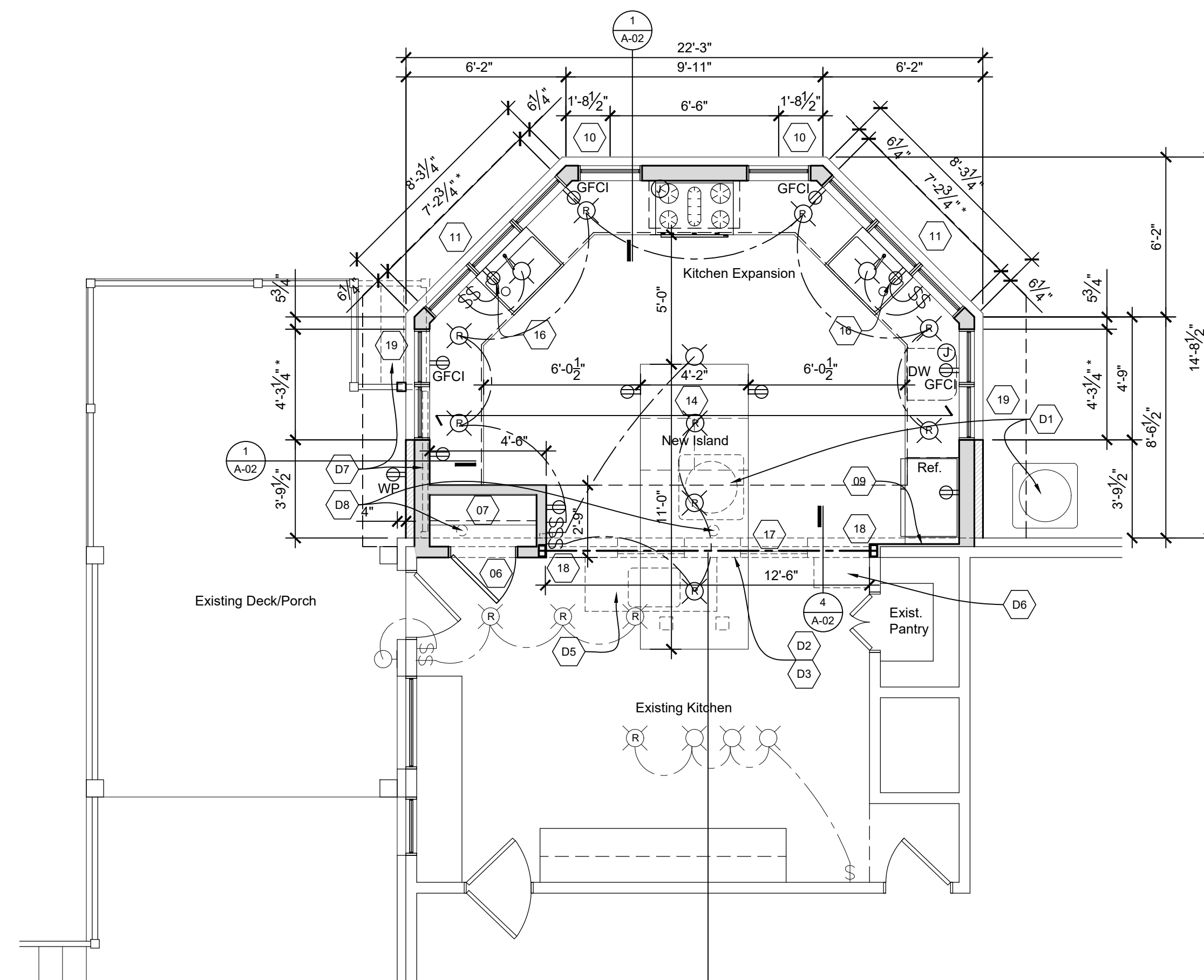

**Floor Plan**

Scale: 1/4"=1'-0"

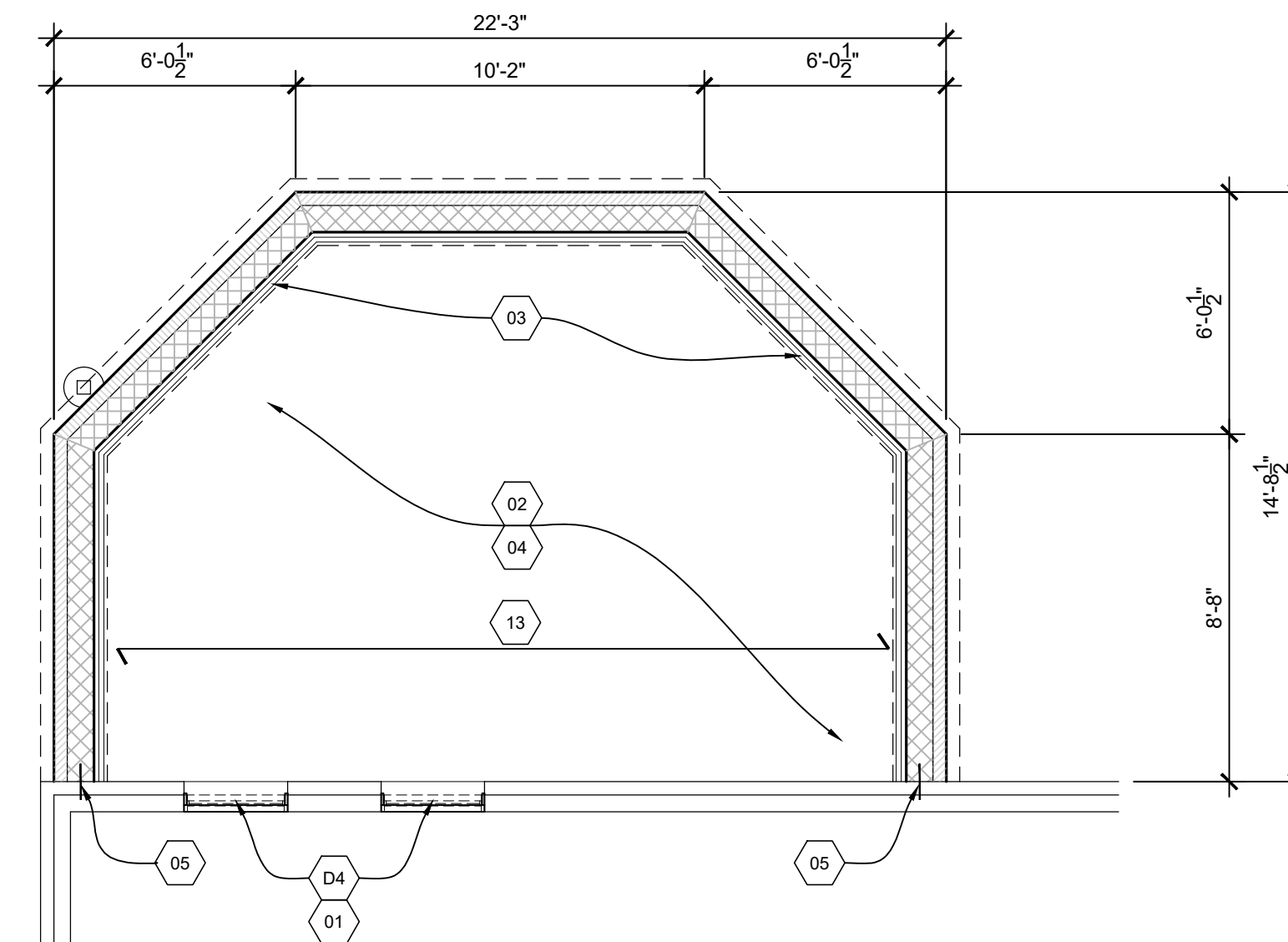

**Foundation Plan**

Scale: 1/4"=1'-0"

**DESIGN NOTES:**

These residential plans are designed to and all new construction shall comply with:

- 2015 Michigan Residential Code
- First Floor Live Load = 40# s.f.
- Second Floor Live Load = 30# s.f.
- Roof Ground Snow Load = 25# s.f.

**Plans and Notes**

REVISION FOR	DATE
Construction	06/17/20
Owner Revisions	07/06/21
Owner Revisions	11/23/21

**Residence Addition for Kevin Prihod**  
605 Chicago Blvd.  
Detroit, MI 48202

APPROVED	DRAWING DATE
	05/22/2020

PROJECT No:  
**18-415.02**

SHEET No:  
**A - 01**

**D. S. WRIGHT & ASSOCIATES, P. C.**  
ARCHITECTURE & PLANNING  
44456 CLARE BLVD., PLYMOUTH, MICHIGAN 48170  
TELEPHONE • 734.377-4632

ASSOCIATE ARCHITECT

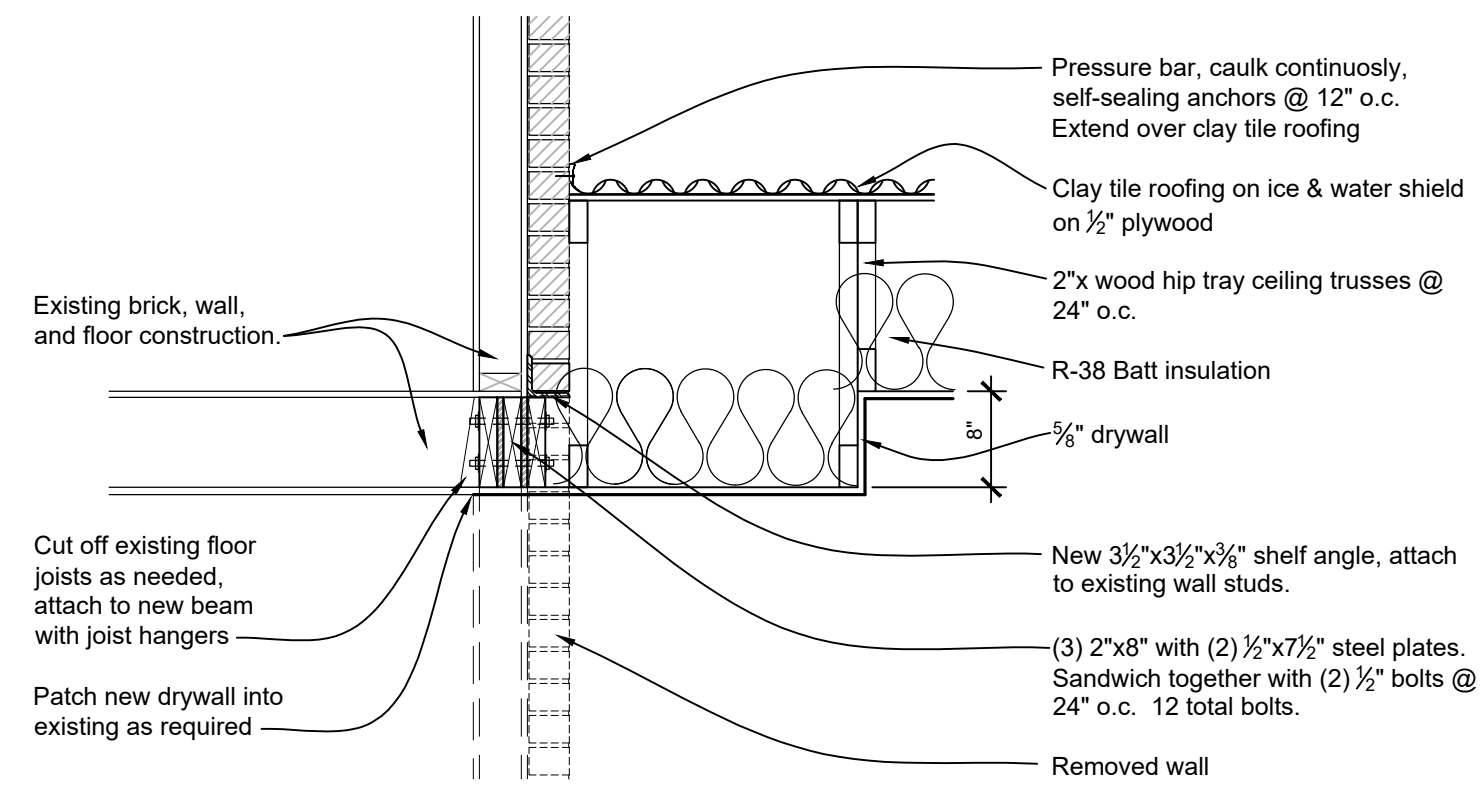

**2**  
A-01  
**Beam Detail**  
Scale: 1/2"=1'-0"

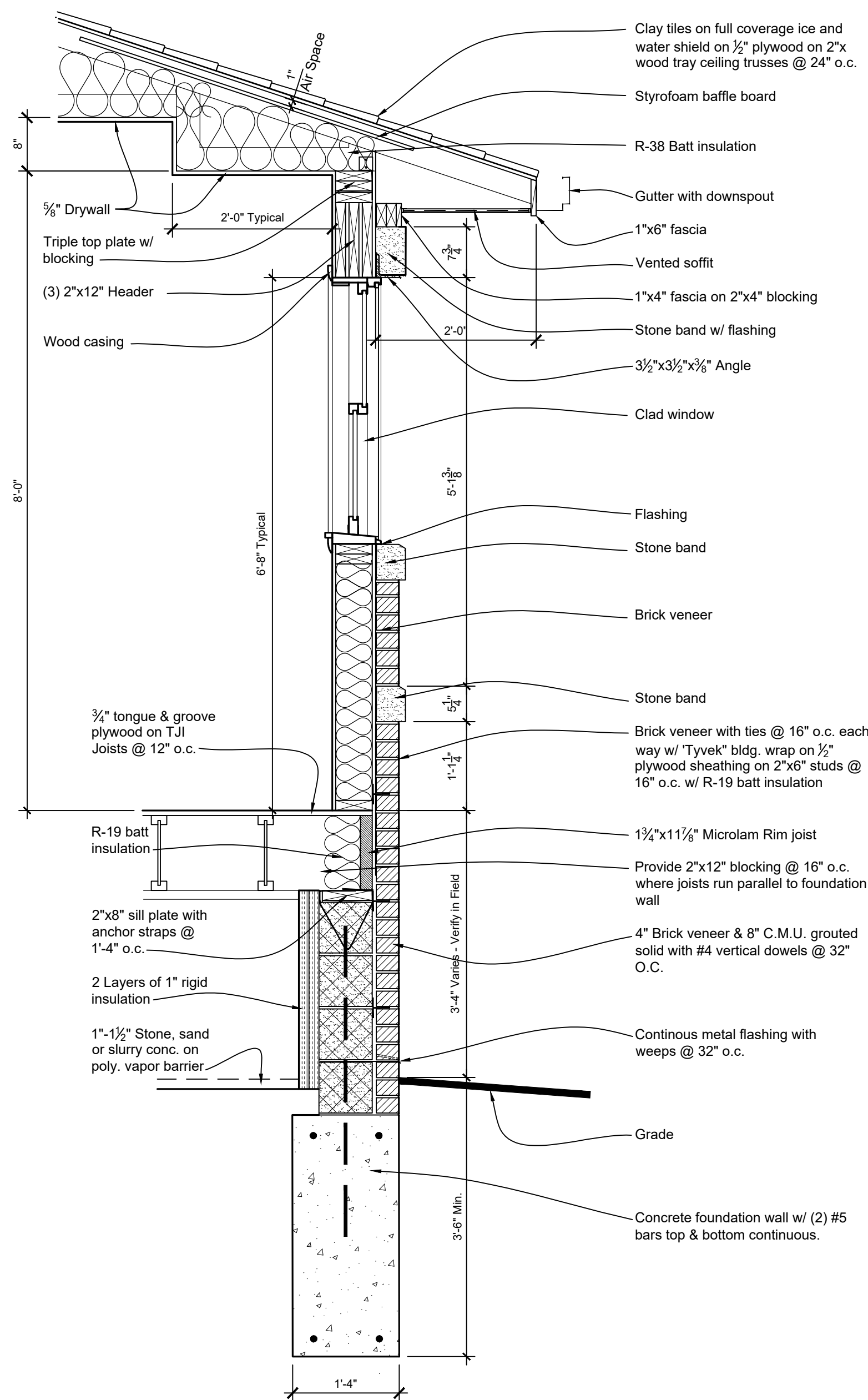

**1**  
A-01  
**Typical Section**  
Scale: 3/4"=1'-0"

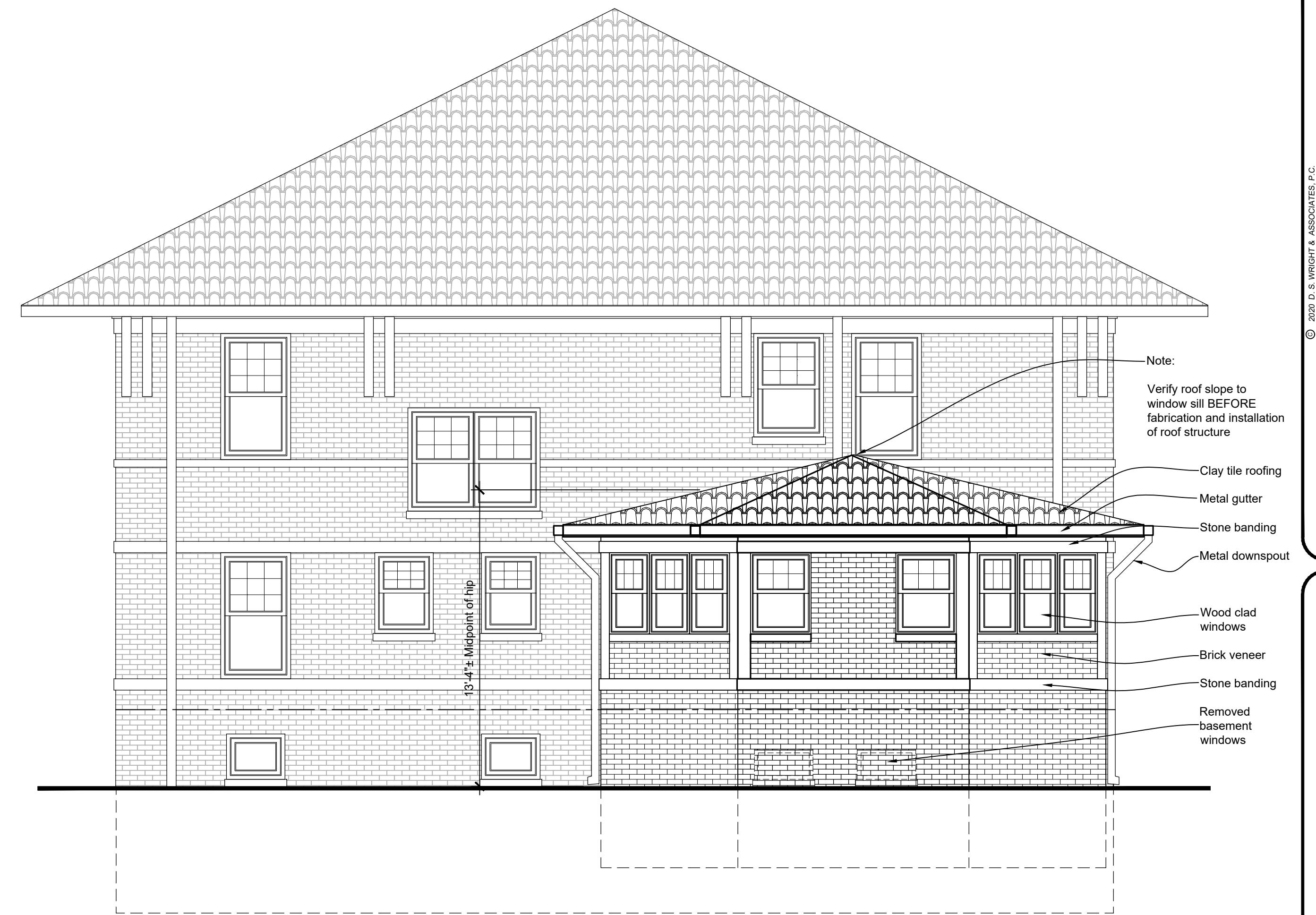

**West Elevation**  
Scale: 1/4"=1'-0"

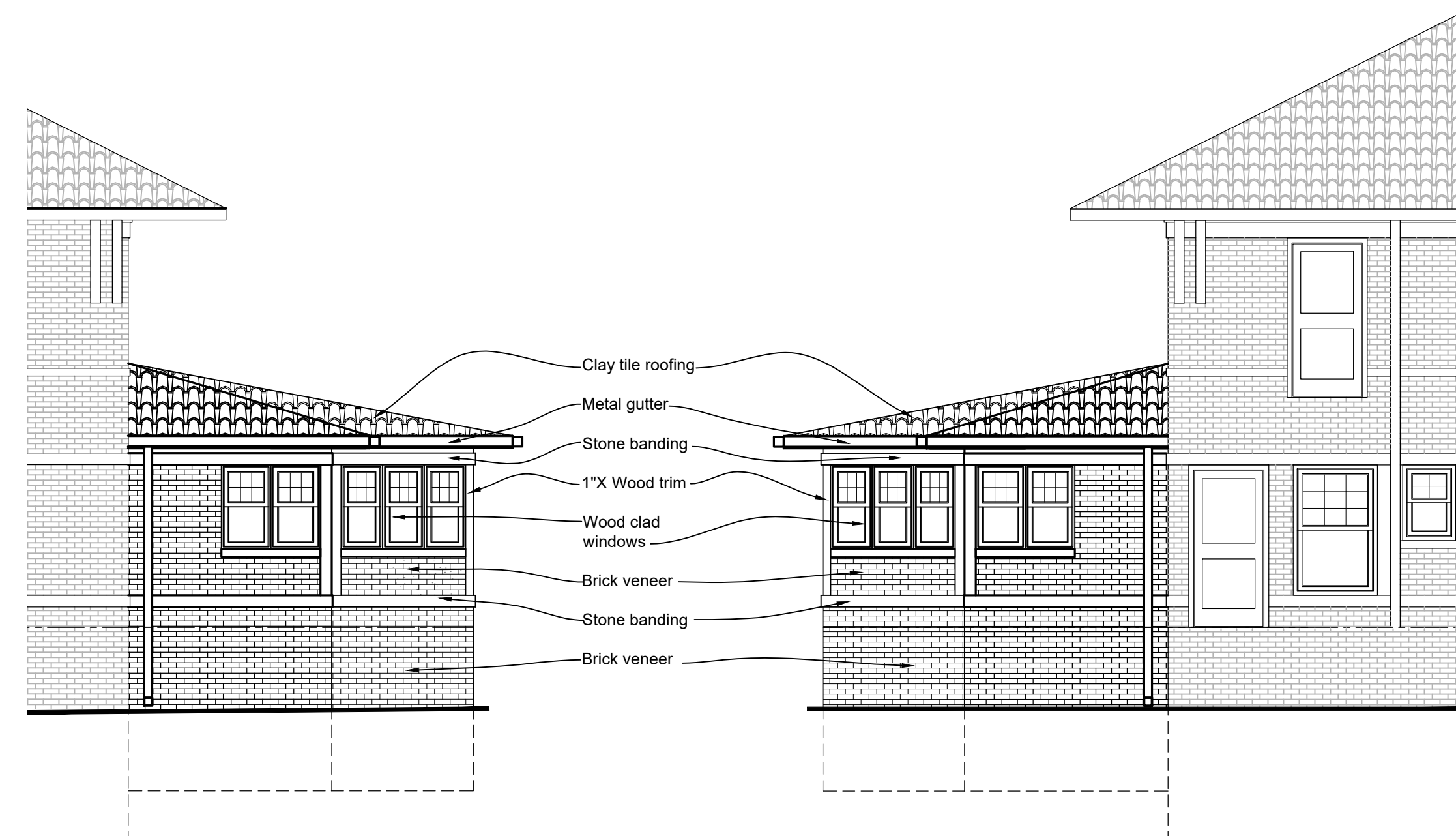

**North Elevation**  
Scale: 1/4"=1'-0"

**South Elevation**  
Scale: 1/4"=1'-0"

**Elevation Notes:**

- All fascia's and trim to be covered with pre-finished metal, match existing
- Windows: Andersen 400 Series Woodwright Windows, color white.
- Brick: Sioux City Brick, color Fine Arts Velour, big standard, if available.
- Gutters and Downspouts: Match existing gutters & downspouts.
- Verify ALL colors and materials with the Owner.
- Verify all vertical masonry dimensions with existing building.

© 2020 D. S. WRIGHT & ASSOCIATES, P.C.  
**D. S. WRIGHT & ASSOCIATES, P. C.**  
ARCHITECTURE & PLANNING  
44456 CLARE BLVD, PLYMOUTH, MICHIGAN 48170  
TELEPHONE • 734 377-4632

**Elevations & Details**

REVISION	DATE
Construction	06/17/20
Owner Revisions	07/06/21
Owner Revisions	11/23/21

**Residence Addition for Kevin Prihod**  
605 Chicago Blvd.  
Detroit, MI 48202

APPROVED	DRAWING DATE
	05/22/2020

PROJECT No:  
**18-415.02**

SHEET No:  
**A - 02**



Elevations & Details



TILE

of the  
**LUDOWIC**

- 1 Ridge
- 2 Torsional
- 3 Hip
- 4 Eave System



2 Cornice Returns  
 A. A narrow

**Sioux City Brick**  
 Since 1913

American Owned - American Made

**DISTRICT COMMISSION  
 & PERMIT PROCES**

*Fine Art Velour*



LEGACY COLLECTION

# FRENCH INTERLO

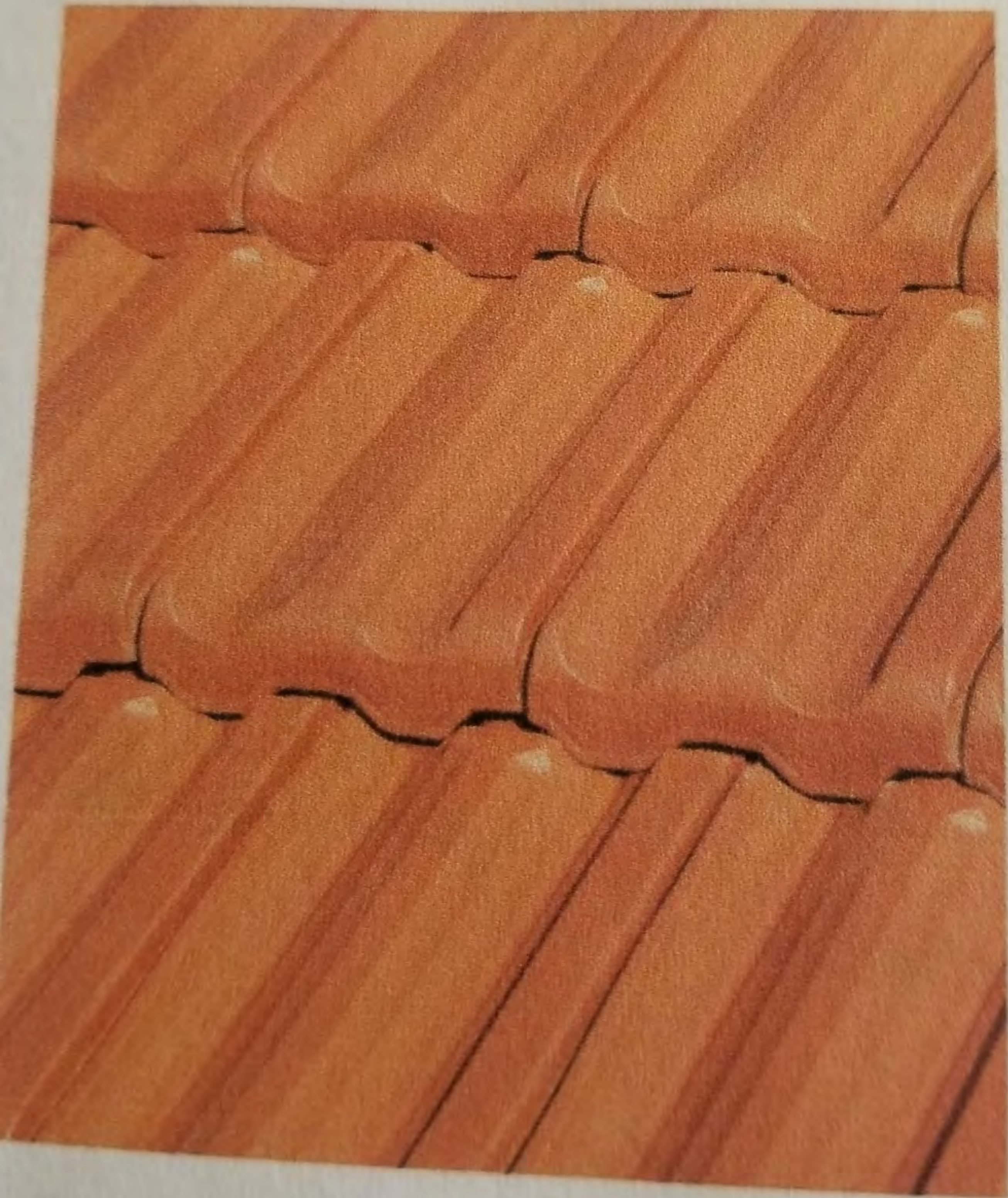

Introduced in the 1890s Ludowici's

# FRENCH INTERLOCKING TILE

LU

4 Closed Ridge End  
(Not shown on diagram, see below)

Field Tile





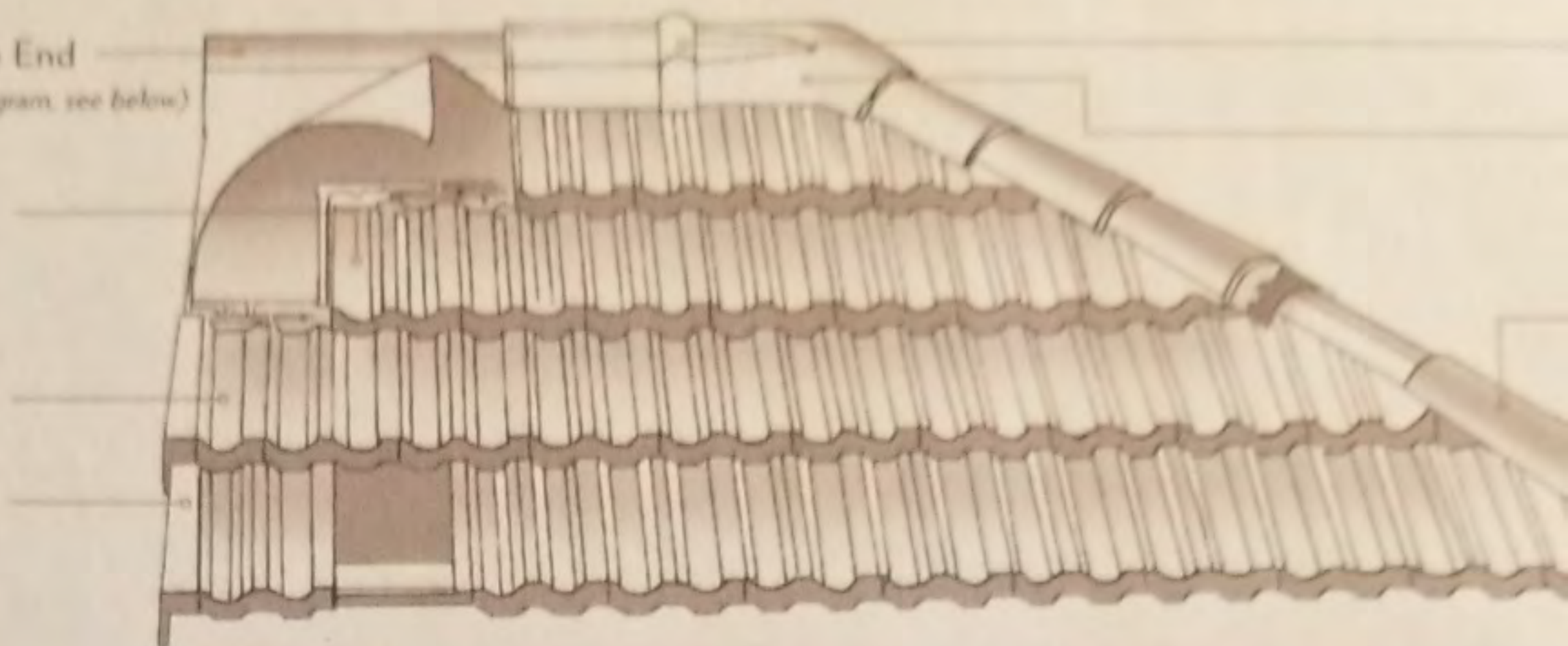



31 End Band

30 Detached Gable Rake

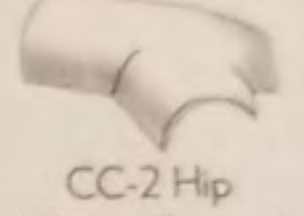

## HIP & RIDGE

Visit [www.ludowici.com](http://www.ludowici.com) to download a detailed product sheet on Hip & Ridge

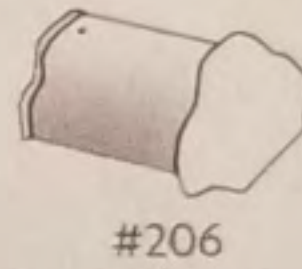
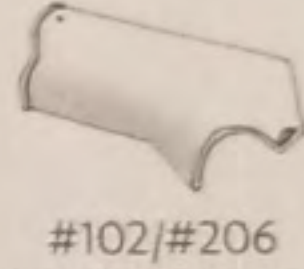
	1	2	3	4	
PROFILE	HIP STARTER	HIP	RIDGE	CLOSED RIDGE END	TE
Circular Cover Hip & Ridge Trim Group	 CC-Hip Starter	 CC-Hip	 CC-Ridge	 CC-Closed Ridge End	 CC-2 Hip 1 Ridge Terminal
#102/#206 Hip & Ridge Trim Group	 #152 Hip Starter	 #102 Hip Roll	 #206 Ridge	 #206 Closed Ridge End	 #102/#206 2 Hip 1 Ridge Terminal

## FITTINGS

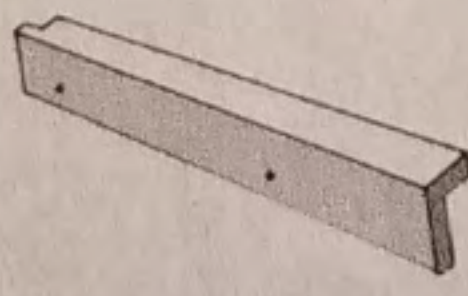
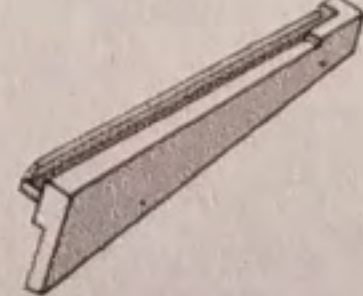
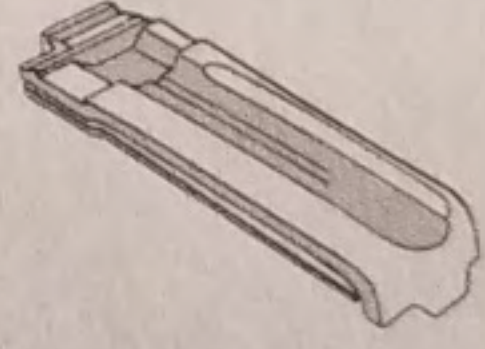
PROFILE	30 DETACHED GABLE RAKE		31 END BAND
	 Left Rake	 Right Rake	
Length	16 1/4"		16 1/4"
Exposure	13 3/8"		13 3/8"
Weight	2.9 lbs./pc.		5.7 lbs./pc.

MAKING YOUR DECISIONS  
PERFECTLY CLEAR.



# YOU'VE GOT QUESTIONS. ANDERSEN ANSWERS.

Whether you're replacing old windows, remodeling your home or building a new house, you have lots of questions about the best way to solve your problems and fulfill your dreams. Andersen has the answers. But don't take our word for it. Instead, take it from the millions of people just like you who have gone through the same process you're going through now. For over 100 years, homeowners have turned to Andersen for answers, and in the process they've made Andersen the most enjoyed windows and doors in America. When you choose Andersen, you're not only getting superior products that perform. You're getting ultimate peace of mind. So take a closer look at Andersen® windows and doors in the pages ahead, and take comfort in your decision to choose Andersen. It's one choice that's perfectly clear.



What makes Andersen® windows & doors perform?

Page 4



Are you replacing, remodeling or building?

Page 6



REPLACE



REMODEL



BUILD

How do windows & doors influence style? Page 8





# 6

What are the six simple selection steps?

Page 14



What are the different Andersen® window & door choices?

Page 30



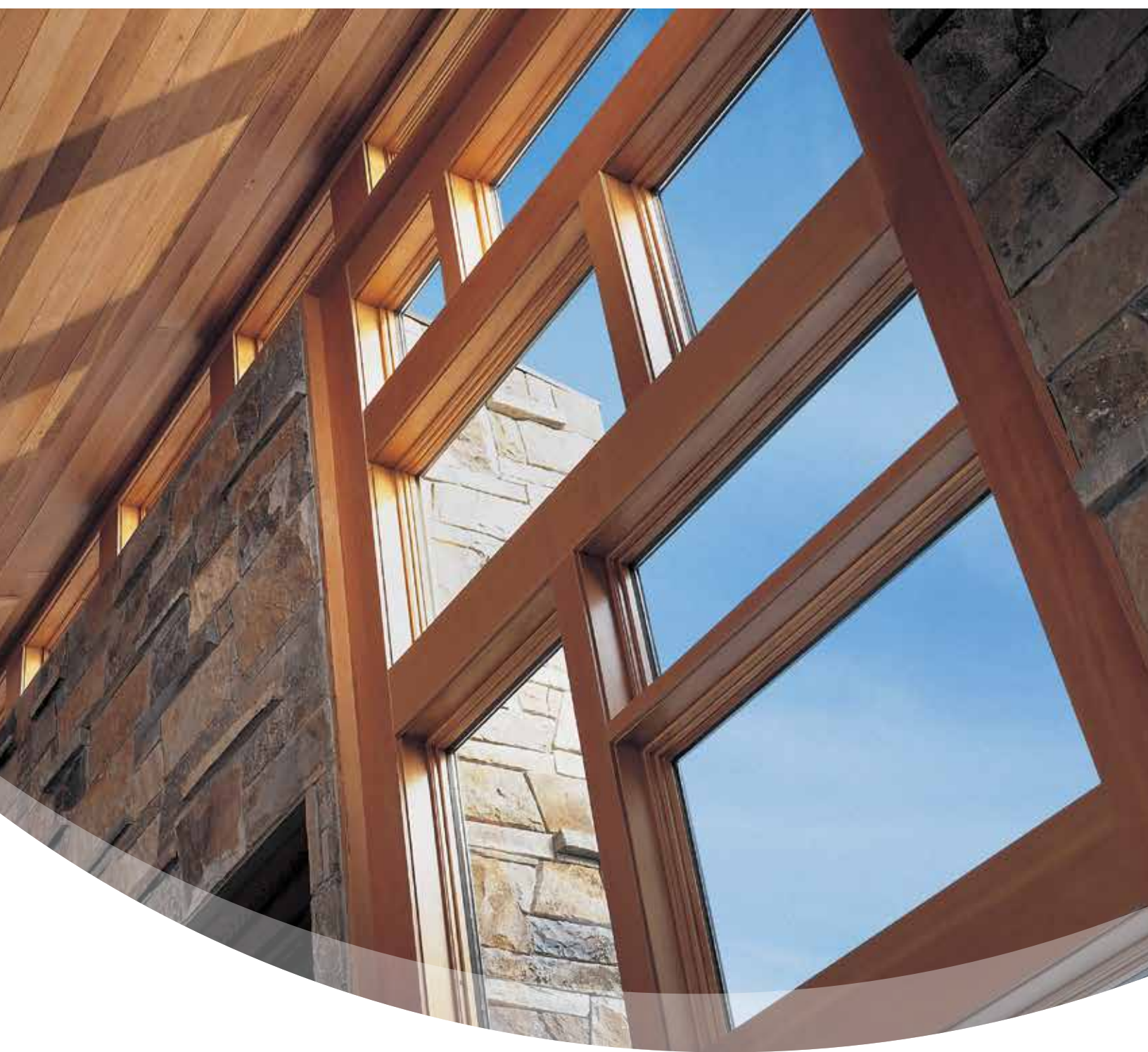

## **WHAT MAKES ANDERSEN<sup>®</sup> WINDOWS & DOORS PERFORM?**

**From energy efficiency and durability to low maintenance,** Andersen designs and builds windows and patio doors that are among the best-performing products in the industry. It's been that way for more than a hundred years, and Andersen is committed to constant innovation as well as rigorous testing of performance and quality to make sure we continue setting the highest possible bar for performance. That's why peace of mind comes standard on all Andersen<sup>®</sup> windows and patio doors.

LUDOWICI®  
*Trusted. Timeless. Terra Cotta.*



ARCHITECTURAL TERRA COTTA  
ROOFING PRODUCTS CATALOG





*For over 130 years, architects, homeowners,  
universities, commercial and government clients have  
turned to Ludowici for uniquely beautiful architectural  
terra cotta products that stand the test of time.*

## TABLE OF CONTENTS

The Ludowici Difference .....	3
Ludowici’s Warranty and Green Promise .....	4
Historic Renovations.....	5
Colors and Textures of Ludowici.....	7
Legacy Collection.....	9
Accessories and Trim.....	71
Graduated and Tower Tile.....	73
Chimney Pots and Wall Coping.....	73
Additional Profiles .....	74
Underlayment and Fasteners.....	74
Old World Collection.....	75
Quarry Tile Flooring.....	77
Wall Cladding and Solar Shades.....	79
Factory of Ideas.....	81

## — THE LUDOWICI DIFFERENCE —

Over 400 years ago in Rome, Italy, the Ludowici family became famous for its expertly crafted roof tile. Today, that old-world legacy continues in the small town of New Lexington, Ohio — where Ludowici still operates in one of its original manufacturing facilities. Built on over 130 years of meticulous craftsmanship and innovation, Ludowici has a long-trusted reputation for developing exceptionally beautiful architectural terra cotta products that last for centuries.

### UNMATCHED DURABILITY

Ludowici products last a lifetime in any climate — even the harshest environments — for enduring luxury and beauty that will never fade.

### EXCEPTIONAL QUALITY

Ludowici's unmatched materials and processes result in a product that's second to none and delivers a lifetime of beauty.

### AFFORDABLE LUXURY

Ludowici has multiple solutions to fit a broad range of lifestyles and budgets.

### CUSTOM CRAFTSMANSHIP

Ludowici's product line can be infinitely customized and handcrafted to the finest detail to match any color or fit any architectural style — from modern to old-world.

### DOMESTIC PRODUCT

For over 130 years, Ludowici tiles have been made in New Lexington, Ohio, with raw materials sourced just 5 miles away.

### COMPANY LONGEVITY

Our history speaks for itself — high-end homeowners, architects and commercial clients have been trusting Ludowici since 1888.

### PERSONAL SERVICE

Every customer receives personal attention, and every order is handled with a personal touch.





**75** YEAR WARRANTY

## PEACE OF MIND FOR A LIFETIME

Ludowici roof tiles and floor tiles manufactured in New Lexington, Ohio are backed by a 75-year material warranty — unmatched in the industry — delivering peace of mind to even the most demanding jobs. Our world-class warranty is included in the cost of your terra cotta tiles and includes color fastness, guaranteeing your roof will remain just as beautiful as the day it was installed.

## LUDOWICI'S GREEN PROMISE

At Ludowici, we are committed to manufacturing architectural terra cotta products that honor their heritage from the earth. There are many qualifications that we strive to meet each and every day to help us live up to this promise. Ludowici products are made of locally sourced, natural materials that are produced through a unique process that creates no waste. Ludowici tiles are chemically inert and 100% recyclable, have an average life expectancy of over 100 years and offer energy savings commonly exceeding 20% over asphalt roofing.

Ludowici products also earn some or all of the many certifications from the four main organizations setting the standards for sustainability: Cool Roof Rating Council, Cradle to Cradle, Energy Star and U.S. Green Building Council's LEED program.



Ludo 360™ is a special clay body blend made of clay scrap, shale and waste material that produces a clay tile with 40% post-industrial content. Ludowici can make any of our standard profiles, trim pieces and accessories with our Ludo 360 clay body. Add that to one of our LEED, CRRC and Energy Star color glazes, and you have a truly environmentally friendly roof option.

For more information about Ludowici's Green Promise, visit: [ludowici.com/solutions/green-sustainable](http://ludowici.com/solutions/green-sustainable)





**EAST LAKE GOLF CLUB**  
*Atlanta, GA*



**PENNSYLVANIA STATE CAPITOL**  
*Harrisburg, PA*



**GROVE PARK INN & SPA**  
*Asheville, NC*



**UNION STATION**  
*Denver, CO*

## HISTORIC RENOVATIONS

For over 130 years, Ludowici has crafted hundreds of different profiles of terra cotta roof tiles as well as thousands of different trim parts ranging from the heavily ornate designs of the Victorian era to the simpler lines of the second industrial revolution. The unique styling and detail of Ludowici tiles and trim are critical components to maintaining the character and charm of historic buildings. However, as architectural styles and tastes have evolved so has Ludowici's product line. Even though some profiles are no longer standard, Ludowici has a vast library of historic patterns and designs.

Using historic catalogs, drawings and technical guides going back to the 1800s, Ludowici's technical service department can identify and quote replacement parts for your historic roof. In addition to replicating Ludowici's own historic tile profiles and trim, Ludowici can match tiles from long gone manufacturers such as B. Mifflin Hood and Heinz.





# RENOVATION QUICKSHIP

Ludowici's history as the leader in architectural terra cotta products in the United States since 1888 makes us a trusted partner in home renovation and historic restoration projects. Our unique Renovation QuickShip program allows you to order small quantities of frequently used historic tiles for repairing your roof. These select profiles, trim and colors usually ship in 7-14 days from receipt of a complete order.

## RENOVATION QUICKSHIP ROOF TILE PROFILES

CHARACTERISTIC	13 1/4" SPANISH	CLOSED SHINGLE	CLASSIC	FRENCH
Profile				
Size	9 3/4" x 13 1/4"	8 3/4" x 11" x 1 3/16"	9" x 14"	9" x 16 1/4"
Surface	Smooth	Smooth	Smooth	Smooth
Fittings Available	Top Fixtures, Eave Closures and Gable Rakes	Gable Rakes	Under Eaves and Gable Rakes	Gable Rakes

## RENOVATION QUICKSHIP HIP AND RIDGE

CHARACTERISTIC	#206 RIDGE	#102 HIP ROLL	CIRCULAR COVER HIP/RIDGE	#211 RIDGE	#118 HIP ROLL	V-HIP/RIDGE
Profile						
Length	13 3/4"	14 1/4"	16"	13 1/4"	14"	14 1/4"
Exposure	12"	12"	13"	12"	12"	12"

## RENOVATION QUICKSHIP COLORS



For more information about Renovation QuickShip program, please visit: [ludowici.com/renovation-quickship](http://ludowici.com/renovation-quickship)

# COLORS OF LUDOWICI

With over 50 designer colors and the ability to custom match nearly any hue, the color possibilities are endless. Plus, our color glazes are kiln fired at extreme temperatures during production, fusing the color into the tile and ensuring that the original tones and hues are retained for generations.

## STANDARD COLOR BLENDS



CLAY RED



SUNSET RED  
AGED SRI VALUE=32



SLATE RED  
AGED SRI VALUE=28



BURGUNDY  
AGED SRI VALUE=26



SUMMER ROSE  
AGED SRI VALUE=36



SANTIAGO ROSE  
AGED SRI VALUE=49



DESERT SAND  
AGED SRI VALUE=51



BARCELONA BUFF  
AGED SRI VALUE=64



EMPIRE GREEN  
AGED SRI VALUE=47



BRIGHT GREEN  
AGED SRI VALUE=45



VINTAGE GREEN  
AGED SRI VALUE=35



BROOKVILLE GREEN\*  
AGED SRI VALUE=26



DARK GREEN  
AGED SRI VALUE=10



MEDITERRANEAN BLUE\*



ROYAL PERSIAN\*  
AGED SRI VALUE=15



HERITAGE BLUE  
AGED SRI VALUE=10



PLUMSTONE  
AGED SRI VALUE=8



BRIAR BROWN  
AGED SRI VALUE=13



AGED OAK  
AGED SRI VALUE=11



BEACH BROWN  
AGED SRI VALUE=23



EBONY  
AGED SRI VALUE=6



BRUNSWICK BLACK  
AGED SRI VALUE=6



MIDNIGHT BLACK\*  
AGED SRI VALUE=0



LAVA BLACK  
AGED SRI VALUE=12



SLATE GRAY  
AGED SRI VALUE=23



MONTPELIER GREEN  
AGED SRI VALUE=33



ASH GRAY  
AGED SRI VALUE=27



MATTE WHITE  
AGED SRI VALUE=90



ADOBE FLECK



PROCESS FLASH



SUNSET RED WITH  
EBONY MIST



EBONY MIST



SIENNA  
AGED SRI VALUE=24



WHITE CEDAR



GOLDEN RED CEDAR



AGED CEDAR



FOREST GREEN  
AGED SRI VALUE=28



AGED COPPER



EARTH GRAY



ANTIQUED  
MONTPELIER GREEN  
AGED SRI VALUE=43



WESTERN CEDAR



VERMONT GRAY BLACK



ANTIQUED  
BRUNSWICK BLACK  
AGED SRI VALUE=30



ANTIQUED  
SLATE GRAY  
AGED SRI VALUE=43



MOTTLED GREEN  
PURPLE

**75** YEAR WARRANTY

Ludowici is proud to include color in our 75-year material warranty.

Colors are shown for representation purposes only. Due to monitor and print calibration differences, these chips should not be used for final product selection. Tiles ordered should be chosen from actual samples available at the time of order. Ludowici reserves the right to alter and adjust products, colors and finishes at any time. Please contact a sales representative for more information.

\*Gloss glazes

## IMPRESSIONIST SERIES BLENDS

The Impressionist Series utilizes two or three complementary shades applied randomly over a base color to create the patina of a century old roof.

Standard blends can be selected or custom blends can be created using different percentages of the Impressionist Series colors.

The Impressionist Series colors are available on all barrel, interlocking and shingle tiles, excluding French.

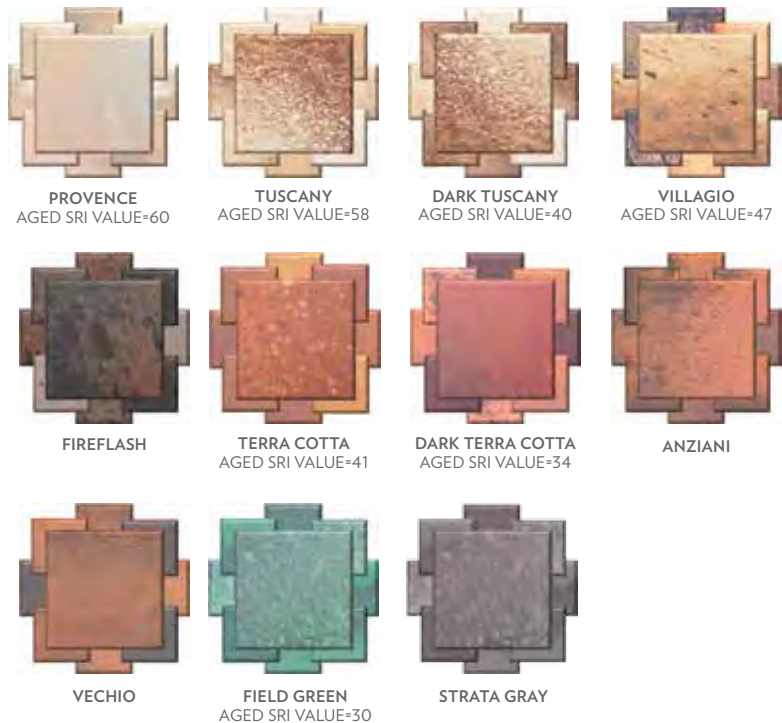

## TERRA COTTA TEXTURES

At Ludowici, our skilled craftsman can recreate a number of finishes that authentically replicate the surface of age-old tiles. Custom textures can be applied to match historic applications or to meet your specific design aesthetic. Textures reduce glare reflecting off the tile and allow the true color to show through. Many tile textures are applied by hand which allows each tile to have a unique, handmade look.

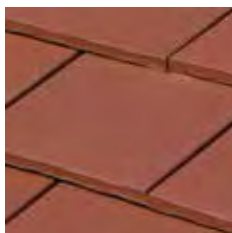

SMOOTH

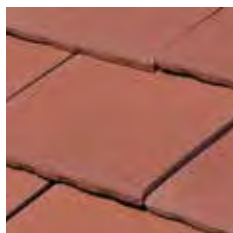

FINE MACHINE SCORE

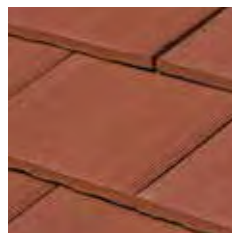

MEDIUM MACHINE SCORE

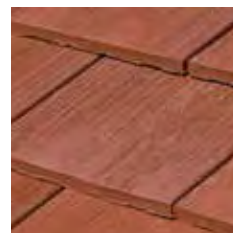

HAND ROUGHED

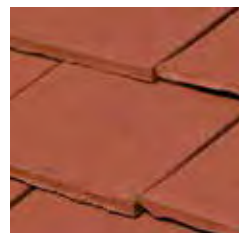

PINHOLE



WEATHERED



HAND SLUSHED

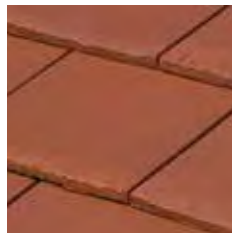

BATTERED & BRUSHED BUTT

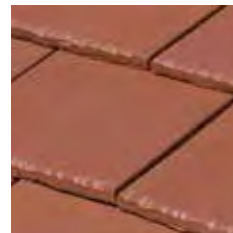

BATTERED BUTT



WARPED

Not every texture is available on every tile profile. Please see your sales representative for more details.



PRIVATE RESIDENCE  
Saint Simons Island, GA

# THE LEGACY COLLECTION

Aptly named, Ludowici's Legacy Collection contains more than 40 tile profiles, 50 colors and a variety of textures that have been crafted and perfected over many generations. Since every customer's project is unique, the tiles are produced on an order-by-order basis — many by hand. Every aspect of the tile is customizable — color, texture and profile — and every tile is covered by Ludowici's world-class 75-year limited material warranty. The Legacy Collection is divided in three families — barrel tiles, shingle tiles and interlocking tiles.

## BARREL TILES

Ludowici offers a wide range of barrel tiles, so called because of their convex barrel-like shape. The tiles are divided into two varieties based on their design origin, Mission and Spanish, and they are fully customizable.



## SHINGLE TILES

Ludowici's shingle tiles can be divided into two broad categories based on the aesthetic they exude: rustic and formal. With small exposures and unique surface textures, Ludowici shingles can be infinitely customized to meet your specific roofing needs.



## INTERLOCKING TILES

With graceful proportions and classic aesthetics, Ludowici's interlocking tiles combine an elegant appearance with installation efficiencies. Each tile features different surface textures and interlocking channels, and you can choose from a range of flat and dimensional profiles.



# LEGACY COLLECTION

## BARREL TILE

Spanish 13 1/4" .....	11
Spanish 18 3/8" .....	13
Scandia .....	15
Palm Beach Mission 18 3/8" .....	17
Straight Barrel Mission 18 3/8" .....	19
Italia 16" .....	21

## SHINGLE TILE

Antique .....	23
Brittany .....	25
Calais .....	27
Colonial .....	29
Cotswold .....	31
Cottage .....	33
Crude .....	35
Georgian .....	37
Norman .....	39
Provincial .....	41
Rustic Colonial .....	43

## INTERLOCKING

Americana 16" .....	45
Americana 14" .....	47
Century Shake® .....	49
Classic 16" .....	51
Classic 14" .....	53
French .....	55
Lanai 16" .....	57
Lanai 14" .....	59
Lexington Slate® .....	61
LudoShake .....	63
LudoSlate .....	65
Williamsburg 16" .....	67
Williamsburg 14" .....	69



PRIVATE RESIDENCE  
Denver, CO



PRIVATE RESIDENCE  
Atlanta, GA

# SPANISH 13 1/4" BARREL TILE



One of the most popular profiles in Ludowici's Legacy Collection™, Spanish tile is prized for its simple, one-piece barrel design which provides a pattern of distinctive ripples across a roof. Spanish 13 1/4" tile provides an authentic, old European look to any style of architecture from small bungalows to large public institutions. Spanish tiles have a smooth surface, but may be customized with a number of custom textures. Our Spanish tiles are available in all standard and custom colors, mists and blends offered by Ludowici. See the *Colors of Ludowici* brochure for more information about our extensive color program. Ludowici Spanish barrel tile is also available in an 18 3/8" profile.

## PHYSICAL CHARACTERISTICS

CHARACTERISTIC	SPANISH 13 1/4" BARREL TILE	PROFILE
Weight Per Square	900 lbs.	
Pieces Per Square	171 pcs.	
Overall Size	9 3/4" x 13 1/4"	
Exposure	8 1/4" x 10 1/4"	
Installed Barrel Height Off Deck	3" Nominal	
Minimum Slope	4:12	
Color Blends	Available in all standard and custom colors. For more information about Ludowici's color program, please see the <i>Colors of Ludowici</i> brochure.	
Base Texture	Smooth Also available in custom textures.* Please see the <i>Terra Cotta Textures</i> brochure for more information.	

## APPROVALS & CERTIFICATIONS

- ◆ Miami-Dade NOA No: 12-0904.18
- ◆ State of Florida Approval No: FL 13777
- ◆ ASTM C1167 Grade 1 Roof Tile With Water Absorption Less Than 2%
- ◆ Class A Fire Rated
- ◆ IAMPO UES ER-452

## LUDOWICI WARRANTY

All Ludowici tiles are manufactured in the United States and carry a 75-year warranty against color fading and manufacturing defects. For complete warranty details, please visit [www.ludowici.com](http://www.ludowici.com).



# SPANISH 13 1/4" BARREL TILE

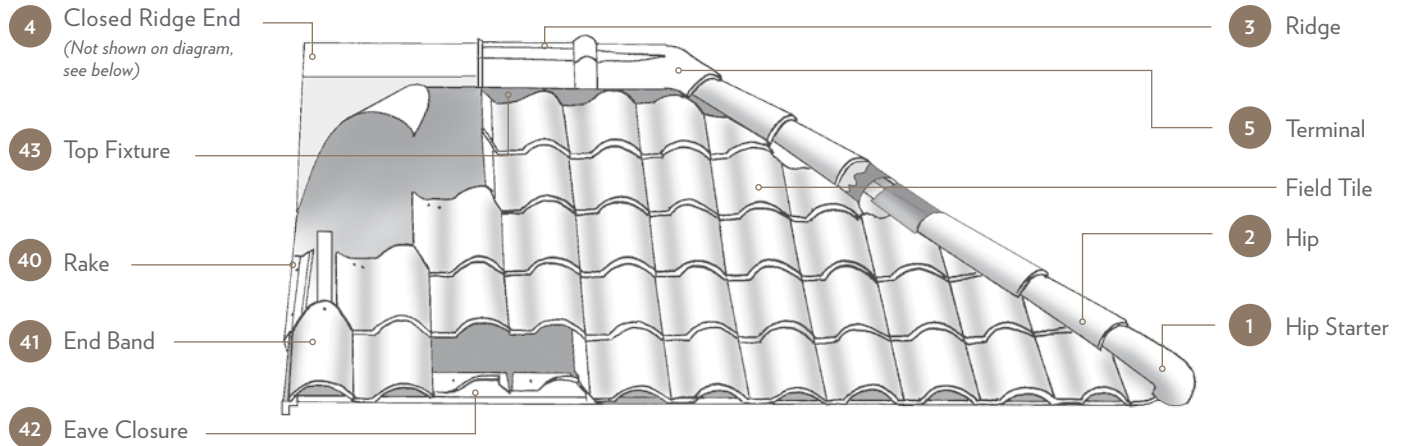

HIP & RIDGE							Visit <a href="http://www.ludowici.com">www.ludowici.com</a> to download a detailed product sheet on Hip, Ridge and Decorative Hip Starters.	
PROFILE	1 HIP STARTER	2 HIP	3 RIDGE	4 CLOSED RIDGE END	5 TERMINAL			
Circular Cover Hip & Ridge Trim Group	CC-Hip Starter	CC-Hip	CC-Ridge	CC-Closed Ridge End	CC-2 Hip 1 Ridge Terminal	CC-Low Bump 2 Hip 1 Ridge Terminal		
#102/#206 Hip & Ridge Trim Group	#152 Hip Starter	#102 Hip Roll	#206 Ridge	#206 Closed Ridge End	#102/#206 2 Hip 1 Ridge Terminal	#405 High Bump 2 Hip 1 Ridge Terminal	#406 High Bump Gable Terminal	

FITTINGS							
PROFILE	40 RAKES		41 END BAND	42 EAVES		43 TOP FIXTURE	
	Left Detached Gable Rake	Right Detached Gable Rake	Rolled Rake	End Band	Eave Closure	Closed Eave	Top Fixture
Length	13 1/4"		13 1/4"	13 1/4"	8 1/4"	13 1/4"	5"
Exposure	10 1/4"		10 1/4"	10 1/4"	8 1/4"	8 1/4" x 10 1/4"	8 1/4"
Weight	2.1 lbs./pc.		5.7 lbs./pc.	4.5 lbs./pc.	1.2 lbs./pc.	6.3 lbs./pc.	1.2 lbs./pc.

\* Textures available include brushed butt, battered butt, heavy machine score, hand roughed, top sand and weathered. Please see a sales representative for more details. Photos are for representation purposes only and should not be used for final product selection. Tiles ordered should be chosen from actual samples available at the time of order. Ludowici reserves the right to alter and adjust products, colors and finishes at any time. Please contact a sales representative for more information.



# SPANISH 18 <sup>3</sup>/<sub>8</sub>" BARREL TILE



One of the most popular profiles in Ludowici's Legacy Collection™, Spanish tile is prized for its simple, one-piece barrel design which provides a pattern of distinctive ripples across a roof. Often synonymous with clay roof tile, Spanish tile enhances virtually any style of architecture from small bungalows to large public institutions. Spanish tiles have a smooth surface but may be customized with a number of custom textures. Our Spanish tiles are available in all standard and custom colors, mists and blends offered by Ludowici. See the *Colors of Ludowici* brochure for more information about our extensive color program. For a more authentic old European look, consider Spanish 13 <sup>1</sup>/<sub>4</sub>" tile, or for a higher profile and more dramatic appearance, consider one of Ludowici's Mission tiles.

## PHYSICAL CHARACTERISTICS

CHARACTERISTIC	SPANISH 18 <sup>3</sup> / <sub>8</sub> " BARREL TILE	PROFILE
Weight Per Square	800 lbs.	
Pieces Per Square	114 pcs.	
Overall Size	9 <sup>3</sup> / <sub>4</sub> " x 18 <sup>3</sup> / <sub>8</sub> "	
Exposure	8 <sup>1</sup> / <sub>4</sub> " x 15 <sup>3</sup> / <sub>8</sub> "	
Installed Barrel Height Off Deck	3" Nominal	
Minimum Slope	4:12	
Color Blends	Available in all standard and custom colors. For more information about Ludowici's color program, please see the <i>Colors of Ludowici</i> brochure.	
Base Texture	Smooth Also available in custom textures. Please see the <i>Terra Cotta Textures</i> brochure for more information.	

## APPROVALS & CERTIFICATIONS

- ◆ Miami-Dade NOA No: 12-0904.18
- ◆ State of Florida Approval No: FL 13777
- ◆ ASTM C1167 Grade 1 Roof Tile With Water Absorption Less Than 2%
- ◆ Class A Fire Rated
- ◆ IAMPO UES ER-452

## LUDOWICI WARRANTY

All Ludowici tiles are manufactured in the United States and carry a 75-year warranty against color fading and manufacturing defects. For complete warranty details, please visit [www.ludowici.com](http://www.ludowici.com).



# SPANISH 18 3/8" BARREL TILE

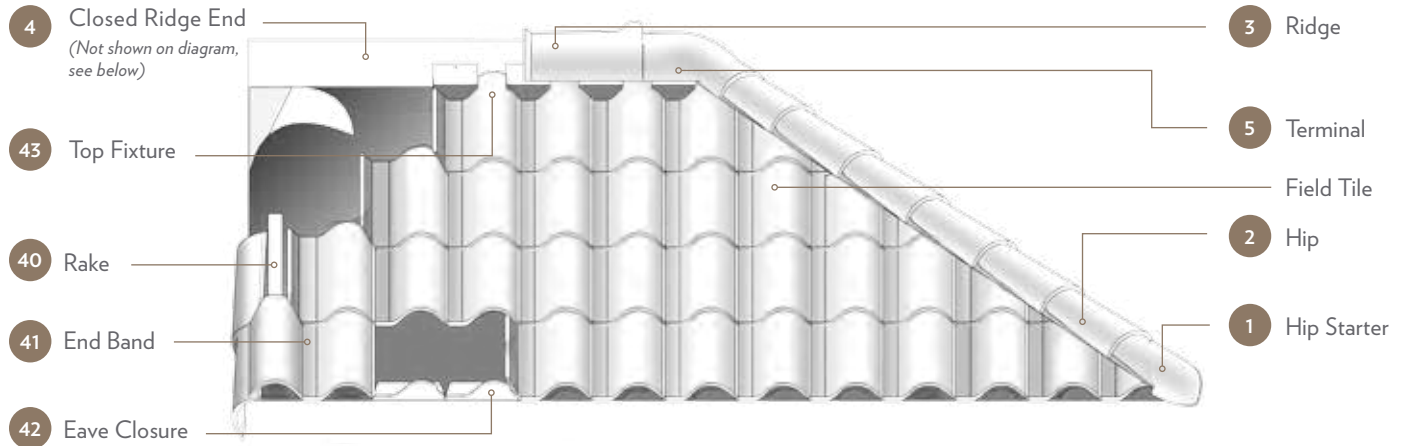

HIP & RIDGE							
Visit <a href="http://www.ludowici.com">www.ludowici.com</a> to download a detailed product sheet on Hip, Ridge and Decorative Hip Starters.							
PROFILE	1 HIP STARTER	2 HIP	3 RIDGE	4 CLOSED RIDGE END	5 TERMINAL		
<b>Circular Cover Hip &amp; Ridge Trim Group</b>	CC-Hip Starter	CC-Hip	CC-Ridge	CC-Closed Ridge End	CC-2 Hip 1 Ridge Terminal	CC-Low Bump 2 Hip 1 Ridge Terminal	
<b>#102/#206 Hip &amp; Ridge Trim Group</b>	#152 Hip Starter	#102 Hip Roll	#206 Ridge	#206 Closed Ridge End	#102/#206 2 Hip 1 Ridge Terminal	#405 High Bump 2 Hip 1 Ridge Terminal	#406 High Bump Gable Terminal

FITTINGS						
PROFILE	40 RAKES	41 END BAND	42 EAVES			43 TOP FIXTURE
	Rolled Rake	End Band	Eave Closure	Barrel Eave Pan*	Closed Eave	Top Fixture
<b>Length</b>	18 3/8"	18 3/8"	8 1/4"	18 3/8"	18 3/8"	5"
<b>Exposure</b>	15 3/8"	15 3/8"	8 1/4"	8 1/4" x 15 3/8"	8 1/4" x 15 3/8"	8 1/4"
<b>Weight</b>	6.8 lbs./pc.	4.6 lbs./pc.	1.2 lbs./pc.	9.0 lbs./pc.	8.0 lbs./pc.	1.2 lbs./pc.

\* Barrel eave cover piece not shown, but required when using barrel eave pan.

Photos are for representation purposes only and should not be used for final product selection. Tiles ordered should be chosen from actual samples available at the time of order. Ludowici reserves the right to alter and adjust products, colors and finishes at any time. Please contact a sales representative for more information.

# SCANDIA BARREL TILE



Scandia tile is synonymous with clay roof tile from northern Europe. Its wide pan and low profile barrel offer a unique and subtle roof texture suitable for a wide range of architectural styles. For a higher profile and more dramatic appearance consider one of Ludowici's Spanish tiles. Scandia tiles are available in all standard and custom colors, mixes and blends offered by Ludowici. See the *Colors of Ludowici* brochure for more information about our extensive color program.

## PHYSICAL CHARACTERISTICS

CHARACTERISTIC	SCANDIA BARREL TILE	PROFILE
Weight Per Square	926 lbs.	
Pieces Per Square	188 pcs.	
Overall Size	8 3/4" x 13 1/4"	
Exposure	7 1/2" x 10 1/4"	
Installed Barrel Height Off Deck	3" Nominal	
Minimum Slope	4:12	
Color Blends	Available in all standard and custom colors. For more information about Ludowici's color program, please see the <i>Colors of Ludowici</i> brochure.	
Base Texture	Smooth Also available in custom textures.* Please see the <i>Terra Cotta Textures</i> brochure for more information.	

## APPROVALS & CERTIFICATIONS

- ♦ ASTM C1167 Grade 1 Roof Tile With Water Absorption Less Than 2%



## LUDOWICI WARRANTY

All Ludowici tiles are manufactured in the United States and carry a 75-year warranty against color fading and manufacturing defects. For complete warranty details, please visit [www.ludowici.com](http://www.ludowici.com).



\*Textures available include battered butt, brushed butt, heavy machine score, hand roughed, top sand and weathered. Please see a sales representative for more details.

Photos are for representation purposes only and should not be used for final product selection. Tiles ordered should be chosen from actual samples available at the time of order. Ludowici reserves the right to alter and adjust products, colors and finishes at any time. Please contact a sales representative for more information.

# SCANDIA BARREL TILE

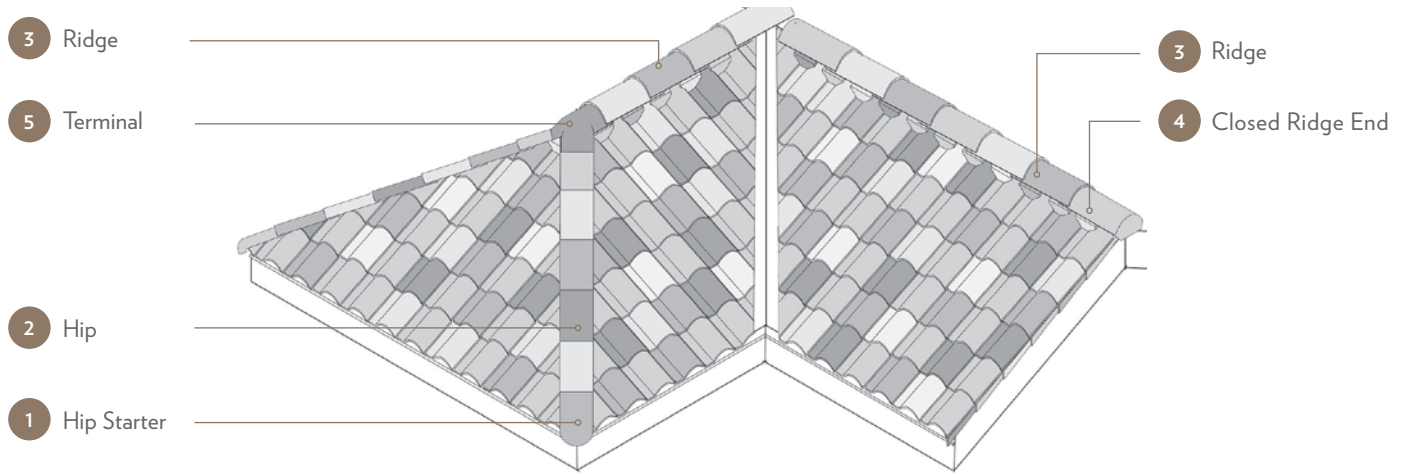

**HIP & RIDGE** Visit [www.ludowici.com](http://www.ludowici.com) to download a detailed product sheet on Hip, Ridge and Decorative Hip Starters.

PROFILE	1 HIP STARTER	2 HIP	3 RIDGE	4 CLOSED RIDGE END	5 TERMINAL		
<b>Circular Cover Hip &amp; Ridge Trim Group</b>	CC-Hip Starter	CC-Hip	CC-Ridge	CC-Closed Ridge End	CC-2 Hip 1 Ridge Terminal	CC-Low Bump 2 Hip 1 Ridge Terminal	
<b>#102/#206 Hip &amp; Ridge Trim Group</b>	#152 Hip Starter	#102 Hip Roll	#206 Ridge	#206 Closed Ridge End	#102/#206 2 Hip 1 Ridge Terminal	#405 High Bump 2 Hip 1 Ridge Terminal	#406 High Bump Gable Terminal

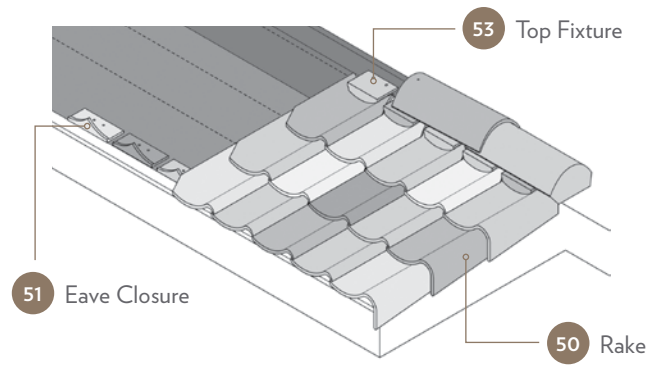
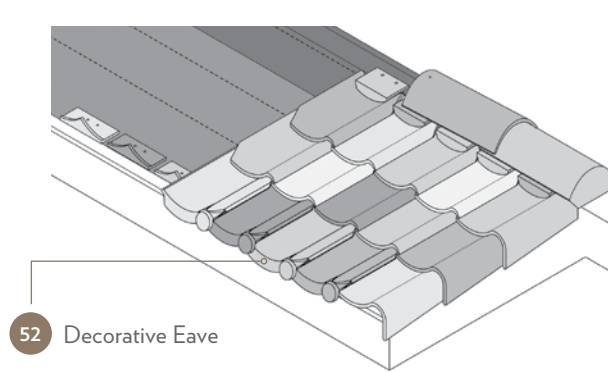

**FITTINGS**

PROFILE	50 ATTACHED RAKE	51 EAVE CLOSURE	52 DECORATIVE EAVE	53 TOP FIXTURE
<b>Length</b>	13 1/4"	7 1/4"	13 1/4"	5 11/16"
<b>Exposure</b>	9 3/8" x 10 1/4"	7 1/2"	7 1/2" x 10 1/4"	7 1/2"
<b>Weight</b>	7.4 lbs./pc.	.94 lbs./pc.	6.5 lbs./pc.	.86 lbs./pc.

Use short course tiles as shorter cap tiles in the first row of a "laid-tight method" installation and as pans in the last row at the ridge.

# PALM BEACH MISSION 18 3/8" TILE



Ludowici's Palm Beach Mission is a mission barrel system comprised of tapered covers and straight barrel pans with a smooth surface. The longer tiles mean fewer pieces per square creating the most economical of Ludowici's mission tiles. Tiles can be laid in straight rows or staggered. Palm Beach Mission tiles have a smooth surface but may be customized with a number of custom textures. Palm Beach Mission tiles are available in all standard and custom colors, mists and blends offered by Ludowici. See the *Colors of Ludowici* brochure for more information about our extensive color program.

## PHYSICAL CHARACTERISTICS

CHARACTERISTIC	PALM BEACH MISSION 18 3/8" TILE	PROFILE
Weight Per Square	1165 lbs.	
Pieces Per Square	163 pcs.	
Overall Size	8" x 18 3/8"	
Exposure	11 1/2" C.C. x 15 3/8"	
Installed Barrel Height Off Deck	4 3/8" Nominal	
Minimum Slope	5:12	
Color Blends	Available in all standard and custom colors. For more information about Ludowici's color program, please see the <i>Colors of Ludowici</i> brochure.	
Base Texture	Smooth Also available in custom textures. Please see the <i>Terra Cotta Textures</i> brochure for more information.	

## APPROVALS & CERTIFICATIONS

- ◆ Miami-Dade NOA No: 12-0904.17
- ◆ State of Florida Approval No: FL 13777
- ◆ ASTM C1167 Grade 1 Roof Tile With Water Absorption Less Than 2%
- ◆ Class A Fire Rated
- ◆ IAMPO UES ER-452

## LUDOWICI WARRANTY

All Ludowici tiles are manufactured in the United States and carry a 75-year warranty against color fading and manufacturing defects. For complete warranty details, please visit [www.ludowici.com](http://www.ludowici.com).



# PALM BEACH MISSION 18 3/8" TILE

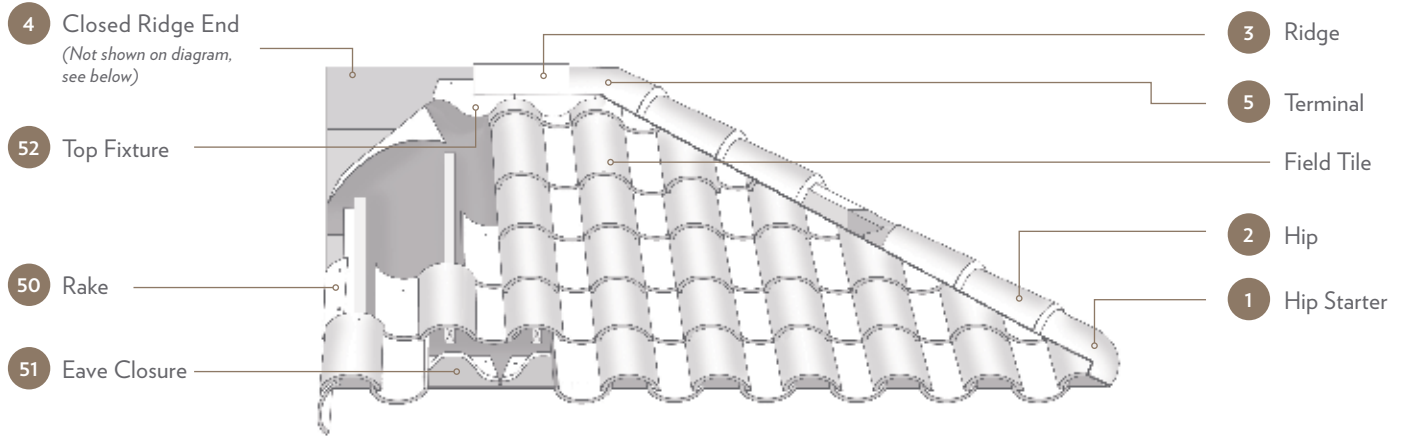

**HIP & RIDGE** Visit [www.ludowici.com](http://www.ludowici.com) to download a detailed product sheet on Hip, Ridge and Decorative Hip Starters.

PROFILE	1 HIP STARTER	2 HIP	3 RIDGE	4 CLOSED RIDGE END	5 TERMINAL		
<b>Circular Cover Hip &amp; Ridge Trim Group</b>	CC-Hip Starter	CC-Hip	CC-Ridge	CC-Closed Ridge End	CC-2 Hip 1 Ridge Terminal	CC-Low Bump 2 Hip 1 Ridge Terminal	
<b>#102/#206 Hip &amp; Ridge Trim Group</b>	#152 Hip Starter	#102 Hip Roll	#206 Ridge	#206 Closed Ridge End	#102/#206 2 Hip 1 Ridge Terminal	#405 High Bump 2 Hip 1 Ridge Terminal	#406 High Bump Gable Terminal

**FITTINGS**

PROFILE	50 ROLLED RAKE	51 EAVE CLOSURE	52 TOP FIXTURE	SHORT COURSE*
<b>Length</b>	18 3/8"	11 1/2"	7 1/2"	15 3/8"
<b>Exposure</b>	15 3/8"	11 1/2"	11 1/2"	12 3/8"
<b>Weight</b>	7.1 lbs./pc.	1.7 lbs./pc.	1.7 lbs./pc.	6.5 lbs./pc.

\* Use short course tiles as shorter cap tiles in the first row of a "laid-tight method" installation and as pans in the last row at the ridge.

Photos are for representation purposes only and should not be used for final product selection. Tiles ordered should be chosen from actual samples available at the time of order. Ludowici reserves the right to alter and adjust products, colors and finishes at any time. Please contact a sales representative for more information.

# STRAIGHT BARREL MISSION 18 3/8" TILE



Inspired by the Spanish Missions of the southwestern U.S., Ludowici's Straight Barrel Mission tile features pans and covers with a smooth clay surface. The longer length of Ludowici's 18 3/8" tile means fewer pieces per square and is the most economical of Ludowici's Mission tiles. They can be laid in straight rows or staggered. Ludowici's Straight Barrel Mission tile is also available in 14 1/4" and 16" profiles. Straight Barrel Mission tiles are available in all standard and custom colors, mists and blends offered by Ludowici. See the *Colors of Ludowici* brochure for more information about our extensive color program.

## PHYSICAL CHARACTERISTICS

CHARACTERISTIC	STRAIGHT BARREL MISSION 18 3/8" TILE	PROFILE
Weight Per Square	1165 lbs.	
Pieces Per Square	163 pcs.	
Overall Size	8" x 18 3/8"	
Exposure	11 1/2" C.C. x 15 3/8"	
Installed Barrel Height Off Deck	4 3/8" Nominal	
Minimum Slope	5:12	
Color Blends	Available in all standard and custom colors. For more information about Ludowici's color program, please see the <i>Colors of Ludowici</i> brochure.	
Base Texture	Smooth Also available in custom textures. Please see the <i>Terra Cotta Textures</i> brochure for more information.	

## APPROVALS & CERTIFICATIONS

- ◆ Miami-Dade NOA No: 12-0904.17
- ◆ State of Florida Approval No: FL 13777
- ◆ ASTM C1167 Grade 1 Roof Tile With Water Absorption Less Than 2%
- ◆ Class A Fire Rated
- ◆ IAMPO UES ER-452

## LUDOWICI WARRANTY

All Ludowici tiles are manufactured in the United States and carry a 75-year warranty against color fading and manufacturing defects. For complete warranty details, please visit [www.ludowici.com](http://www.ludowici.com).



# STRAIGHT BARREL MISSION 18 3/8" TILE

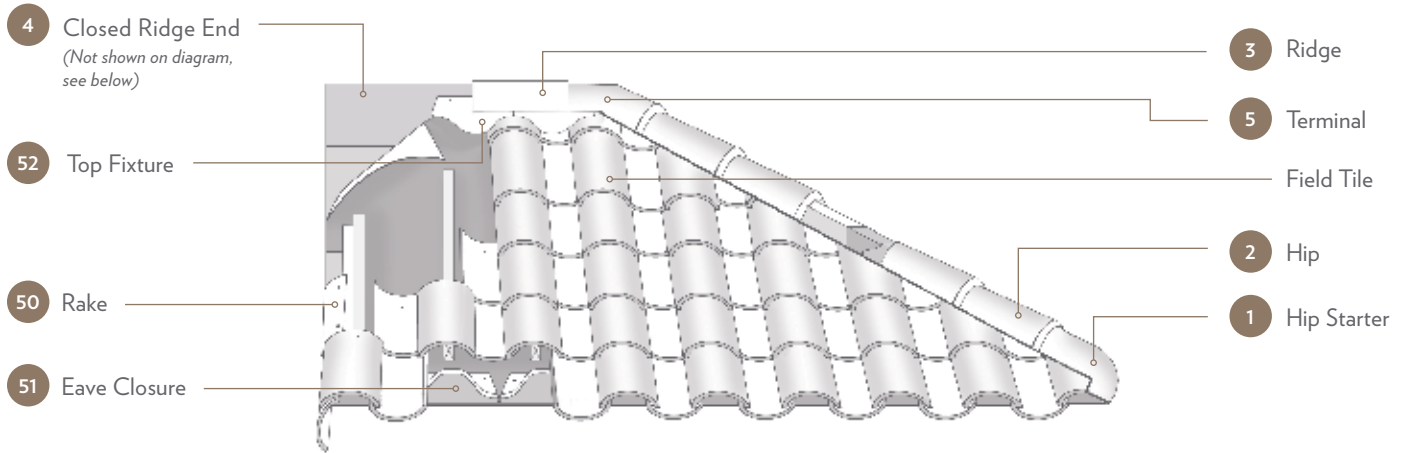

HIP & RIDGE							
	Visit <a href="http://www.ludowici.com">www.ludowici.com</a> to download a detailed product sheet on Hip, Ridge and Decorative Hip Starters.						
PROFILE	1 HIP STARTER	2 HIP	3 RIDGE	4 CLOSED RIDGE END	5 TERMINAL		
Circular Cover Hip & Ridge Trim Group	CC-Hip Starter	CC-Hip	CC-Ridge	CC-Closed Ridge End	CC-2 Hip 1 Ridge Terminal	CC-Low Bump 2 Hip 1 Ridge Terminal	
#102/#206 Hip & Ridge Trim Group	#152 Hip Starter	#102 Hip Roll	#206 Ridge	#206 Closed Ridge End	#102/#206 2 Hip 1 Ridge Terminal	#405 High Bump 2 Hip 1 Ridge Terminal	#406 High Bump Gable Terminal

FITTINGS				
PROFILE	50 ROLLED RAKE	51 EAVE CLOSURE	52 TOP FIXTURE	SHORT COURSE*
Length	18 3/8"	11 1/2"	7 1/2"	15 3/8"
Exposure	15 3/8"	11 1/2"	11 1/2"	12 3/8"
Weight	7.1 lbs./pc.	1.7 lbs./pc.	1.7 lbs./pc.	6.5 lbs./pc.

\* Use short course tiles as shorter cap tiles in the first row of a "laid-tight method" installation and as pans in the last row at the ridge.

Photos are for representation purposes only and should not be used for final product selection. Tiles ordered should be chosen from actual samples available at the time of order. Ludowici reserves the right to alter and adjust products, colors and finishes at any time. Please contact a sales representative for more information.



# ITALIA 16" PAN AND COVER TILE



Ludowici's Italia tile with straight barrel caps and flat pans faithfully matches the authentic look and character of centuries-old Italian roofs. Italia tiles are available in all standard and custom colors, mists and blends offered by Ludowici. See the *Colors of Ludowici* brochure for more information about our extensive color program.

## PHYSICAL CHARACTERISTICS

CHARACTERISTIC	ITALIA 16" PAN AND COVER TILE	PROFILE
Weight Per Square	950 lbs.	
Pieces Per Square	148 pcs.	
Overall Size	Cover 8" x 16", Pan 9 3/4" x 16"	
Exposure	15" C.C. x 13"	
Installed Barrel Height Off Deck	4 3/8" Nominal	
Minimum Slope	5:12	
Color Blends	Available in all standard and custom colors. For more information about Ludowici's color program, please see the <i>Colors of Ludowici</i> brochure.	
Base Texture	Smooth Also available in custom textures.* Please see the <i>Terra Cotta Textures</i> brochure for more information.	

## APPROVALS & CERTIFICATIONS

- ◆ ASTM C1167 Grade 1 Roof Tile With Water Absorption Less Than 2%



## LUDOWICI WARRANTY

All Ludowici tiles are manufactured in the United States and carry a 75-year warranty against color fading and manufacturing defects. For complete warranty details, please visit [www.ludowici.com](http://www.ludowici.com).









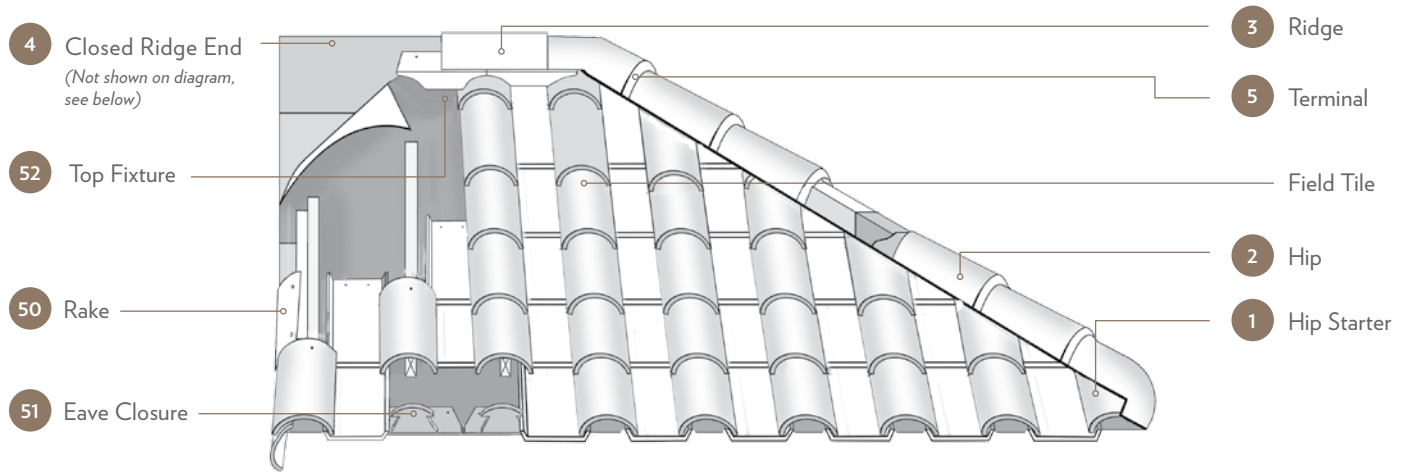





\* Textures available include brushed butt, battered butt, hand roughed, hand slushed, top sand and weathered. Please see a sales representative for more details.

Photos are for representation purposes only and should not be used for final product selection. Tiles ordered should be chosen from actual samples available at the time of order. Ludowici reserves the right to alter and adjust products, colors and finishes at any time. Please contact a sales representative for more information.





# ITALIA 16" PAN AND COVER TILE



**HIP & RIDGE** Visit [www.ludowici.com](http://www.ludowici.com) to download a detailed product sheet on Hip, Ridge and Decorative Hip Starters.

PROFILE	1 HIP STARTER	2 HIP	3 RIDGE	4 CLOSED RIDGE END	5 TERMINAL		
<b>Circular Cover Hip &amp; Ridge Trim Group</b>	 CC-Hip Starter	 CC-Hip	 CC-Ridge	 CC-Closed Ridge End	 CC-2 Hip 1 Ridge Terminal	 CC-Low Bump 2 Hip 1 Ridge Terminal	
<b>#102/#206 Hip &amp; Ridge Trim Group</b>	 #152 Hip Starter	 #102 Hip Roll	 #206 Ridge	 #206 Closed Ridge End	 #102/#206 2 Hip 1 Ridge Terminal	 #405 High Bump 2 Hip 1 Ridge Terminal	 #406 High Bump Gable Terminal

**FITTINGS**

PROFILE	50 ROLLED RAKE	51 EAVE CLOSURE	52 TOP FIXTURE	SHORT COURSE*
				
<b>Length</b>	16"	14 3/4"	11 1/8"	13"
<b>Exposure</b>	13"	15"	15"	10"
<b>Weight</b>	7.0 lbs./pc.	1.7 lbs./pc.	1.7 lbs./pc.	5.1 lbs./pc.

\* Use short course tiles as shorter cap tiles in the first row of a "laid-tight method" installation and as pans in the last row at the ridge.

# ANTIQUE SHINGLE TILE



Uneven lengths, a rough textured surface and severely chipped butts reflecting the feel of old masonry give Ludowici's Antique shingle tile the warmth and character of Old Europe. Antique shingle tiles are available in standard and custom matte colors, mists and blends. See the *Colors of Ludowici* brochure for more information about our extensive color program.

## PHYSICAL CHARACTERISTICS

CHARACTERISTIC	ANTIQUE SHINGLE TILE	PROFILE
Weight Per Square	1650 lbs.	
Pieces Per Square	412 pcs.	
Overall Size	7" x 12" x 1/2"	
Exposure	7" x 5"	
Minimum Slope	5:12	
Color Blends	Available in all standard and custom matte colors. For more information about Ludowici's color program, please see the <i>Colors of Ludowici</i> brochure.	
Base Texture	Roughed Also available in custom textures.* Please see the <i>Terra Cotta Textures</i> brochure for more information.	

## APPROVALS & CERTIFICATIONS

- ◆ Miami-Dade NOA No: 12-0904.14
- ◆ State of Florida Approval No: FL 13777
- ◆ ASTM C1167 Grade 1 Roof Tile With Water Absorption Less Than 2%
- ◆ Class A Fire Rated
- ◆ IAMPO UES ER-452



## LUDOWICI WARRANTY

All Ludowici tiles are manufactured in the United States and carry a 75-year warranty against color fading and manufacturing defects. For complete warranty details, please visit [www.ludowici.com](http://www.ludowici.com).



\*Textures available include hand slushed and top sand. Please see a sales representative for more details.

Photos are for representation purposes only and should not be used for final product selection. Tiles ordered should be chosen from actual samples available at the time of order. Ludowici reserves the right to alter and adjust products, colors and finishes at any time. Please contact a sales representative for more information.

# ANTIQUE SHINGLE TILE

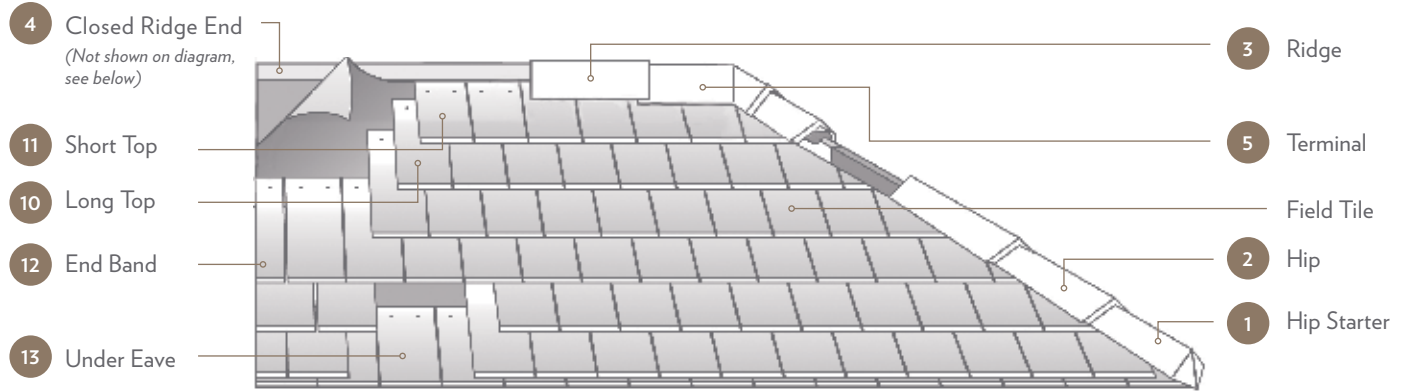

HIP & RIDGE							
Visit <a href="http://www.ludowici.com">www.ludowici.com</a> to download a detailed product sheet on Hip, Ridge and Decorative Hip Starters.							
PROFILE	1 HIP STARTER	2 HIP	3 RIDGE	4 CLOSED RIDGE END	5 TERMINAL		
<b>V-Hip &amp; Ridge Trim Group</b>	V-Hip Starter	V-Hip	V-Ridge	V-Closed Ridge End	V-2 Hip	1 Ridge Terminal	
<b>#118/#211 Hip &amp; Ridge Trim Group</b>	#168 Hip Starter	#118 Hip Roll	#211 Ridge	#211 Closed Ridge End	#118/#211 Hip	2 Hip 1 Ridge Terminal	
<b>Circular Cover Hip &amp; Ridge Trim Group</b>	CC-Hip Starter	CC-Hip	CC-Ridge	CC-Closed Ridge End	CC-2 Hip	1 Ridge Terminal	CC-Low Bump
<b>#102/#206 Hip &amp; Ridge Trim Group</b>	#152 Hip Starter	#102 Hip Roll	#206 Ridge	#206 Closed Ridge End	#102/#206 Hip	2 Hip 1 Ridge Terminal	#405 High Bump #406 High Bump Gable Terminal
<b>Old Style Trim Group</b>	Bonnet Hip Starter*	Bonnet Hip Roll* Aries Hip Plate*	Interlocking Ridge				

\* Roof slope on each intersecting roof plane needs to be identical to use these pieces.

FITTINGS					
PROFILE	10 LONG TOP	11 SHORT TOP	12 END BAND	13 UNDER EAVE	HEADER COURSE
<b>Actual Size</b>	7" x 9"	7" x 5"	3 1/2" x 12"	7" x 7"	7" x 12"
<b>Exposure</b>	7" x 5"	7" x 2"	3 1/2" x 5"	7"	7" x 9"
<b>Weight</b>	3.0 lbs./pc.	1.7 lbs./pc.	2.0 lbs./pc.	2.4 lbs./pc.	4.0 lbs./pc.

# BRITTANY SHINGLE TILE



A dramatic textured tile in irregular lengths with the feel of aged stone, Brittany shingle tile provides a truly provincial appearance. Brittany shingle tiles are available in standard and custom matte colors, mists and blends. See the *Colors of Ludowici* brochure for more information about our extensive color program.

## PHYSICAL CHARACTERISTICS

CHARACTERISTIC	BRITTANY SHINGLE TILE	PROFILE
Weight Per Square	1900 lbs.	
Pieces Per Square	412 pcs.	
Overall Size	7" x 12" x 5/8"	
Exposure	7" x 5"	
Minimum Slope	5:12	
Color Blends	Available in all standard and custom matte colors. For more information about Ludowici's color program, please see the <i>Colors of Ludowici</i> brochure.	
Base Texture	Lightly Pressed Stone Also available in custom textures. Please see the <i>Terra Cotta Textures</i> brochure for more information.	

## APPROVALS & CERTIFICATIONS

- ◆ Miami-Dade NOA No: 12-0904.14
- ◆ State of Florida Approval No: FL 13777
- ◆ ASTM C1167 Grade 1 Roof Tile With Water Absorption Less Than 2%
- ◆ Class A Fire Rated
- ◆ IAMPO UES ER-452



## LUDOWICI WARRANTY

All Ludowici tiles are manufactured in the United States and carry a 75-year warranty against color fading and manufacturing defects. For complete warranty details, please visit [www.ludowici.com](http://www.ludowici.com).



Photos are for representation purposes only and should not be used for final product selection. Tiles ordered should be chosen from actual samples available at the time of order. Ludowici reserves the right to alter and adjust products, colors and finishes at any time. Please contact a sales representative for more information.

# BRITTANY SHINGLE TILE

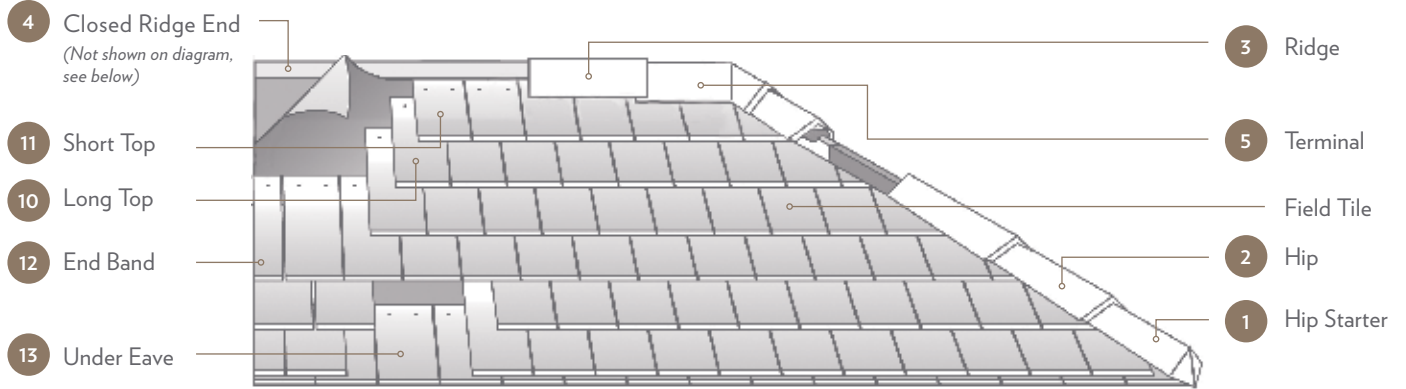

HIP & RIDGE							
Visit <a href="http://www.ludowici.com">www.ludowici.com</a> to download a detailed product sheet on Hip, Ridge and Decorative Hip Starters.							
PROFILE	1 HIP STARTER	2 HIP	3 RIDGE	4 CLOSED RIDGE END	5 TERMINAL		
<b>V-Hip &amp; Ridge Trim Group</b>	V-Hip Starter	V-Hip	V-Ridge	V-Closed Ridge End	V-2 Hip	1 Ridge Terminal	
<b>#118/#211 Hip &amp; Ridge Trim Group</b>	#168 Hip Starter	#118 Hip Roll	#211 Ridge	#211 Closed Ridge End	#118/#211 Hip	2 Hip 1 Ridge Terminal	
<b>Circular Cover Hip &amp; Ridge Trim Group</b>	CC-Hip Starter	CC-Hip	CC-Ridge	CC-Closed Ridge End	CC-2 Hip	1 Ridge Terminal	CC-Low Bump 2 Hip 1 Ridge Terminal
<b>#102/#206 Hip &amp; Ridge Trim Group</b>	#152 Hip Starter	#102 Hip Roll	#206 Ridge	#206 Closed Ridge End	#102/#206 Hip	2 Hip 1 Ridge Terminal	#405 High Bump 2 Hip 1 Ridge Terminal #406 High Bump Gable Terminal
<b>Old Style Trim Group</b>	Bonnet Hip Starter*	Bonnet Hip Roll* Aries Hip Plate*	Interlocking Ridge				

\* Roof slope on each intersecting roof plane needs to be identical to use these pieces.

FITTINGS					
PROFILE	10 LONG TOP	11 SHORT TOP	12 END BAND	13 UNDER EAVE	HEADER COURSE
<b>Actual Size</b>	7" x 9"	7" x 5"	3 1/2" x 12"	7" x 7"	7" x 12"
<b>Exposure</b>	7" x 5"	7" x 2"	3 1/2" x 5"	7"	7" x 9"
<b>Weight</b>	3.5 lbs./pc.	2.0 lbs./pc.	2.4 lbs./pc.	2.7 lbs./pc.	4.6 lbs./pc.

# CALAIS SHINGLE TILE



A cratered surface with a rough bottom edge give Ludowici’s Calais shingle tile the look and character of centuries old roof tile from France. Calais shingle tiles are available in standard and custom matte colors, mists and blends. See the *Colors of Ludowici* brochure for more information about our extensive color program.

## PHYSICAL CHARACTERISTICS

CHARACTERISTIC	CALAIS SHINGLE TILE	PROFILE
Weight Per Square	1600 lbs.	
Pieces Per Square	317 pcs.	
Overall Size	7" x 15" x 1/2"	
Exposure	7" x 6 1/2"	
Minimum Slope	5:12	
Color Blends	Available in all standard and custom matte colors. For more information about Ludowici’s color program, please see the <i>Colors of Ludowici</i> brochure.	
Base Texture	Dimpled Also available in custom textures. Please see the <i>Terra Cotta Textures</i> brochure for more information.	

## APPROVALS & CERTIFICATIONS

- ◆ Miami-Dade NOA No: 12-0904.14
- ◆ State of Florida Approval No: FL 13777
- ◆ ASTM C1167 Grade 1 Roof Tile With Water Absorption Less Than 2%
- ◆ Class A Fire Rated
- ◆ IAMPO UES ER-452



## LUDOWICI WARRANTY

All Ludowici tiles are manufactured in the United States and carry a 75-year warranty against color fading and manufacturing defects. For complete warranty details, please visit [www.ludowici.com](http://www.ludowici.com).



Photos are for representation purposes only and should not be used for final product selection. Tiles ordered should be chosen from actual samples available at the time of order. Ludowici reserves the right to alter and adjust products, colors and finishes at any time. Please contact a sales representative for more information.

# CALAIS SHINGLE TILE

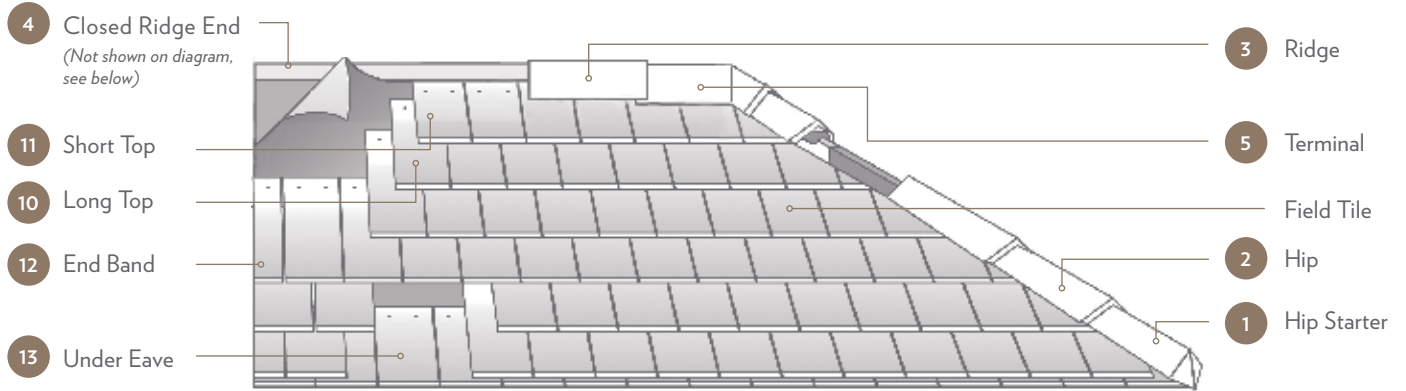

HIP & RIDGE							
Visit <a href="http://www.ludowici.com">www.ludowici.com</a> to download a detailed product sheet on Hip, Ridge and Decorative Hip Starters.							
PROFILE	1 HIP STARTER	2 HIP	3 RIDGE	4 CLOSED RIDGE END	5 TERMINAL		
V-Hip & Ridge Trim Group	V-Hip Starter	V-Hip	V-Ridge	V-Closed Ridge End	V-2 Hip	1 Ridge Terminal	
#118/#211 Hip & Ridge Trim Group	#168 Hip Starter	#118 Hip Roll	#211 Ridge	#211 Closed Ridge End	#118/#211 Hip	2 Hip 1 Ridge Terminal	
Circular Cover Hip & Ridge Trim Group	CC-Hip Starter	CC-Hip	CC-Ridge	CC-Closed Ridge End	CC-2 Hip	1 Ridge Terminal	CC-Low Bump 2 Hip 1 Ridge Terminal
#102/#206 Hip & Ridge Trim Group	#152 Hip Starter	#102 Hip Roll	#206 Ridge	#206 Closed Ridge End	#102/#206 Hip	2 Hip 1 Ridge Terminal	#405 High Bump 2 Hip 1 Ridge Terminal #406 High Bump Gable Terminal
Old Style Trim Group	Bonnet Hip Starter*	Bonnet Hip Roll* Aries Hip Plate*	Interlocking Ridge				

\* Roof slope on each intersecting roof plane needs to be identical to use these pieces.

FITTINGS					
PROFILE	10 LONG TOP	11 SHORT TOP	12 END BAND	13 UNDER EAVE	HEADER COURSE
Actual Size	7" x 10 1/2"	7" x 6 1/2"	3 1/2" x 15"	7" x 8 1/2"	7" x 15"
Exposure	7" x 6 1/2"	7" x 4 1/2"	3 1/2" x 6 1/2"	7"	7" x 12"
Weight	4.2 lbs./pc.	2.6 lbs./pc.	2.9 lbs./pc.	3.4 lbs./pc.	5.0 lbs./pc.



# COLONIAL SHINGLE TILE



Long irregular lengths and a rich grooved texture give Ludowici’s Colonial shingle tile the look and feel of hand split wood shake used on Early American and Colonial buildings. However, they can be customized with a number of different custom texture options to create your desired effect. Colonial shingles are available in all standard and custom matte colors, mists and blends offered by Ludowici. See the *Colors of Ludowici* brochure for more information about our extensive color program. For a deeper, more pronounced hand split wood shake texture, consider Rustic Colonial tile.

## PHYSICAL CHARACTERISTICS

CHARACTERISTIC	COLONIAL SHINGLE TILE	PROFILE
Weight Per Square	1800 lbs.	
Pieces Per Square	310 pcs.	
Overall Size	7 3/8" x 14 5/8" x 5/8"	
Exposure	7 3/8" x 6 5/16"	
Minimum Slope	5:12	
Color Blends	Available in all standard and custom matte colors. For more information about Ludowici’s color program, please see the <i>Colors of Ludowici</i> brochure.	
Base Texture	Grooved Also available in custom textures. Please see the <i>Terra Cotta Textures</i> brochure for more information.	

### APPROVALS & CERTIFICATIONS

- ◆ Miami-Dade NOA No: 12-0904.14
- ◆ State of Florida Approval No: FL 13777
- ◆ ASTM C1167 Grade 1 Roof Tile With Water Absorption Less Than 2%
- ◆ Class A Fire Rated
- ◆ IAMPO UES ER-452



### LUDOWICI WARRANTY

All Ludowici tiles are manufactured in the United States and carry a 75-year warranty against color fading and manufacturing defects. For complete warranty details, please visit [www.ludowici.com](http://www.ludowici.com).



Photos are for representation purposes only and should not be used for final product selection. Tiles ordered should be chosen from actual samples available at the time of order. Ludowici reserves the right to alter and adjust products, colors and finishes at any time. Please contact a sales representative for more information.

# COLONIAL SHINGLE TILE

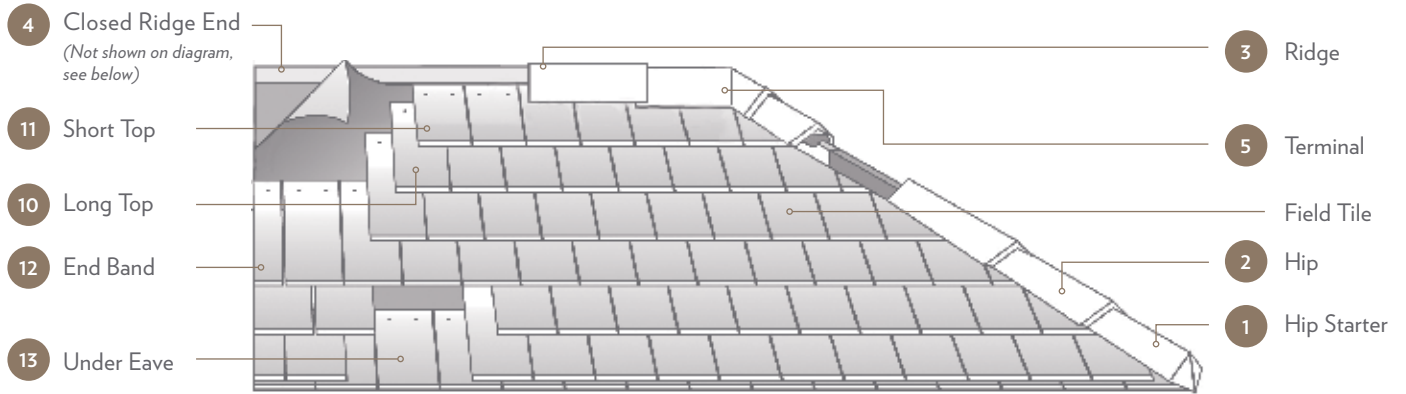

HIP & RIDGE							
Visit <a href="http://www.ludowici.com">www.ludowici.com</a> to download a detailed product sheet on Hip, Ridge and Decorative Hip Starters.							
PROFILE	1 HIP STARTER	2 HIP	3 RIDGE	4 CLOSED RIDGE END	5 TERMINAL		
<b>V-Hip &amp; Ridge Trim Group</b>	V-Hip Starter	V-Hip	V-Ridge	V-Closed Ridge End	V-2 Hip	1 Ridge Terminal	
<b>#118/#211 Hip &amp; Ridge Trim Group</b>	#168 Hip Starter	#118 Hip Roll	#211 Ridge	#211 Closed Ridge End	#118/#211 Hip	2 Hip 1 Ridge Terminal	
<b>Circular Cover Hip &amp; Ridge Trim Group</b>	CC-Hip Starter	CC-Hip	CC-Ridge	CC-Closed Ridge End	CC-2 Hip	1 Ridge Terminal	CC-Low Bump 2 Hip 1 Ridge Terminal
<b>#102/#206 Hip &amp; Ridge Trim Group</b>	#152 Hip Starter	#102 Hip Roll	#206 Ridge	#206 Closed Ridge End	#102/#206 Hip	2 Hip 1 Ridge Terminal	#405 High Bump 2 Hip 1 Ridge Terminal #406 High Bump Gable Terminal
<b>Old Style Trim Group</b>	Bonnet Hip Starter*	Bonnet Hip Roll* Aries Hip Plate*	Interlocking Ridge				

\* Roof slope on each intersecting roof plane needs to be identical to use these pieces.

FITTINGS					
PROFILE	10 LONG TOP	11 SHORT TOP	12 END BAND	13 UNDER EAVE	HEADER COURSE
<b>Actual Size</b>	7 3/8" x 10 1/2"	7 3/8" x 6 1/2"	3 1/2" x 14 5/8"	7 3/8" x 8 1/2"	7 3/8" x 14 5/8"
<b>Exposure</b>	7 3/8" x 6 5/16"	7 3/8" x 3 5/16"	3 1/2" x 6 5/16"	7 3/8"	7 3/8" x 11 5/8"
<b>Weight</b>	4.2 lbs./pc.	2.6 lbs./pc.	2.9 lbs./pc.	3.4 lbs./pc.	5.8 lbs./pc.

# COTSWOLD SHINGLE TILE



Ludowici’s Cotswold shingle tiles feature uneven lengths, chiseled edges and a split stone textured surface reminiscent of Cotswold stone from the English countryside. Cotswold shingle tiles add character and charm to any home design. Cotswold shingle tiles are available in standard and custom matte colors, mists and blends. See the *Colors of Ludowici* brochure for more information about our extensive color program.

## PHYSICAL CHARACTERISTICS

CHARACTERISTIC	COTSWOLD SHINGLE TILE	PROFILE
Weight Per Square	1925 lbs.	
Pieces Per Square	333 pcs.	
Overall Size	7" x 14 3/8" x 5/8"	
Exposure	7" x 6 5/16"	
Minimum Slope	5:12	
Color Blends	Available in all standard and custom matte colors. For more information about Ludowici’s color program, please see the <i>Colors of Ludowici</i> brochure.	
Base Texture	Stone Also available in custom textures. Please see the <i>Terra Cotta Textures</i> brochure for more information.	

## APPROVALS & CERTIFICATIONS

- ♦ ASTM C1167 Grade 1 Roof Tile With Water Absorption Less Than 2%



## LUDOWICI WARRANTY

All Ludowici tiles are manufactured in the United States and carry a 75-year warranty against color fading and manufacturing defects. For complete warranty details, please visit [www.ludowici.com](http://www.ludowici.com).



Photos are for representation purposes only and should not be used for final product selection. Tiles ordered should be chosen from actual samples available at the time of order. Ludowici reserves the right to alter and adjust products, colors and finishes at any time. Please contact a sales representative for more information.

# COTSWOLD SHINGLE TILE

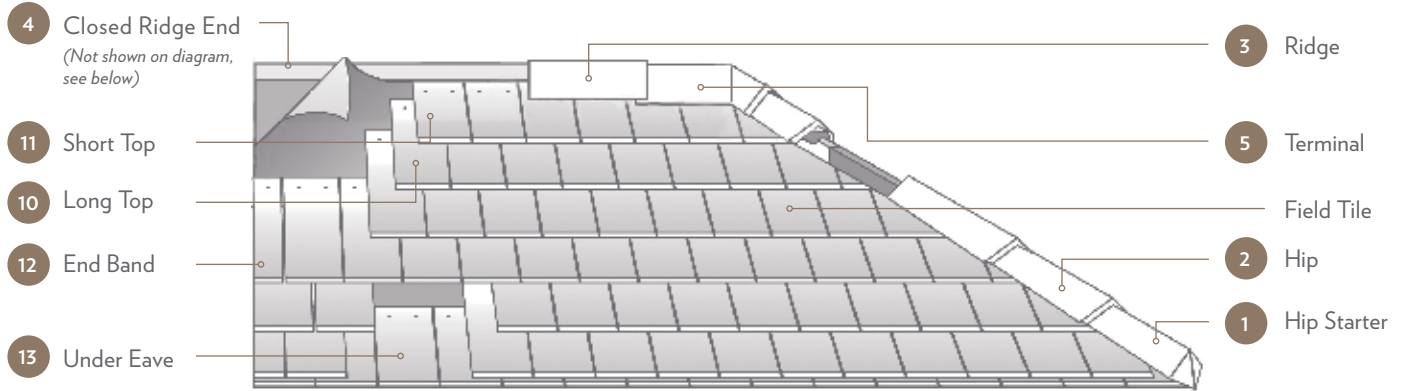

HIP & RIDGE							
Visit <a href="http://www.ludowici.com">www.ludowici.com</a> to download a detailed product sheet on Hip, Ridge and Decorative Hip Starters.							
PROFILE	1 HIP STARTER	2 HIP	3 RIDGE	4 CLOSED RIDGE END	5 TERMINAL		
<b>V-Hip &amp; Ridge Trim Group</b>	V-Hip Starter	V-Hip	V-Ridge	V-Closed Ridge End	V-2 Hip	1 Ridge Terminal	
<b>#118/#211 Hip &amp; Ridge Trim Group</b>	#168 Hip Starter	#118 Hip Roll	#211 Ridge	#211 Closed Ridge End	#118/#211 Hip	2 Hip 1 Ridge Terminal	
<b>Circular Cover Hip &amp; Ridge Trim Group</b>	CC-Hip Starter	CC-Hip	CC-Ridge	CC-Closed Ridge End	CC-2 Hip	1 Ridge Terminal	CC-Low Bump 2 Hip 1 Ridge Terminal
<b>#102/#206 Hip &amp; Ridge Trim Group</b>	#152 Hip Starter	#102 Hip Roll	#206 Ridge	#206 Closed Ridge End	#102/#206 Hip	2 Hip 1 Ridge Terminal	#405 High Bump 2 Hip 1 Ridge Terminal #406 High Bump Gable Terminal
<b>Old Style Trim Group</b>	Bonnet Hip Starter*	Bonnet Hip Roll* Aries Hip Plate*	Interlocking Ridge				

\* Roof slope on each intersecting roof plane needs to be identical to use these pieces.

FITTINGS					
PROFILE	10 LONG TOP	11 SHORT TOP	12 END BAND	13 UNDER EAVE	HEADER COURSE
<b>Actual Size</b>	7" x 10 1/2"	7" x 6 1/2"	3 1/2" x 14 5/8"	7" x 8 1/2"	7" x 14 5/8"
<b>Exposure</b>	7" x 6 5/16"	7" x 4 5/16"	3 1/2" x 6 5/16"	7"	7" x 11 5/8"
<b>Weight</b>	4.2 lbs./pc.	2.6 lbs./pc.	2.9 lbs./pc.	3.4 lbs./pc.	5.8 lbs./pc.

# COTTAGE SHINGLE TILE



Ludowici's Cottage shingle tile is reminiscent of the tiles adorning centuries Old English country cottages. Enhance the bucolic style by laying the 10" roof tiles in a staggered installation. Cottage tiles can be further enhanced by adding custom textures to suit your design preference. Cottage tiles are available in all standard and custom matte colors, mists and blends offered by Ludowici. See the *Colors of Ludowici* brochure for more information about our extensive color program.

For an even more aged look, try Ludowici's Old World Cottage tile. Old World Cottage tile is available in a mix of 8", 9" and 10" widths. Ludowici craftsmen create a rustic appearance by hand-warping 15% of the tiles.

## PHYSICAL CHARACTERISTICS

CHARACTERISTIC	COTTAGE SHINGLE TILE	OLD WORLD COTTAGE			PROFILE
Weight Per Square	1600 lbs.	1600 lbs.			
Pieces Per Square	222 pcs.	248 pcs. (10" Tile: 74, 9" Tile: 82, 8" Tile: 92)			
Overall Size	10" x 15" x 1/2"	8" x 15" x 1/2"	9" x 15" x 1/2"	10" x 15" x 1/2"	
Exposure	10" x 6 1/2"	8" x 6 1/2"	9" x 6 1/2"	10" x 6 1/2"	
Minimum Slope	5:12	5:12			
Color Blends	Available in all standard and custom matte colors. For more information about Ludowici's color program, please see the <i>Colors of Ludowici</i> brochure.				
Base Texture	Weathered or Sanded Also available in custom textures. Please see the <i>Terra Cotta Textures</i> brochure for more information.				

## APPROVALS & CERTIFICATIONS

- ♦ ASTM C1167 Grade 1 Roof Tile With Water Absorption Less Than 2%



## LUDOWICI WARRANTY

All Ludowici tiles are manufactured in the United States and carry a 75-year warranty against color fading and manufacturing defects. For complete warranty details, please visit [www.ludowici.com](http://www.ludowici.com).



Photos are for representation purposes only and should not be used for final product selection. Tiles ordered should be chosen from actual samples available at the time of order. Ludowici reserves the right to alter and adjust products, colors and finishes at any time. Please contact a sales representative for more information.

# COTTAGE SHINGLE TILE

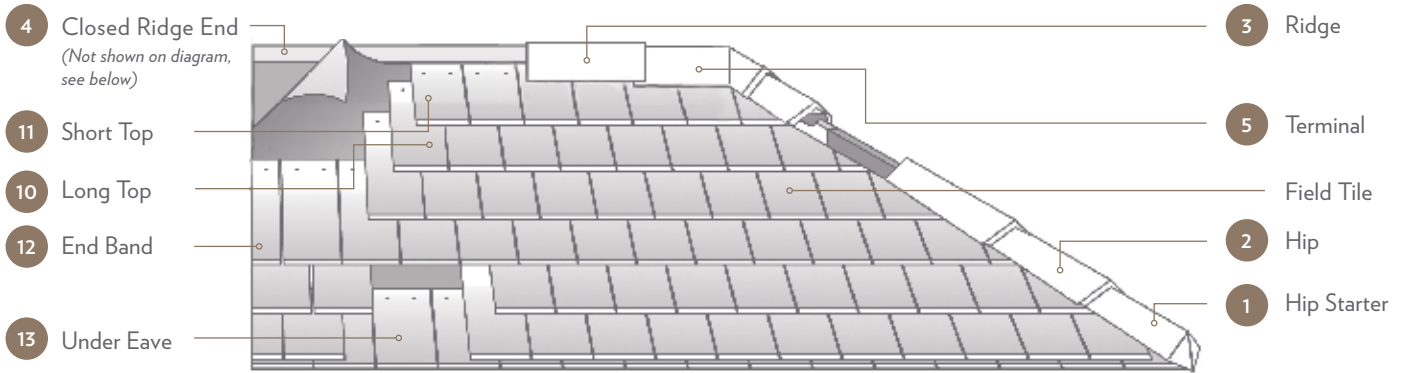

HIP & RIDGE							
Visit <a href="http://www.ludowici.com">www.ludowici.com</a> to download a detailed product sheet on Hip, Ridge and Decorative Hip Starters.							
PROFILE	1 HIP STARTER	2 HIP	3 RIDGE	4 CLOSED RIDGE END	5 TERMINAL		
<b>V-Hip &amp; Ridge Trim Group</b>	V-Hip Starter	V-Hip	V-Ridge	V-Closed Ridge End	V-2 Hip	1 Ridge Terminal	
<b>#118/#211 Hip &amp; Ridge Trim Group</b>	#168 Hip Starter	#118 Hip Roll	#211 Ridge	#211 Closed Ridge End	#118/#211 Hip	2 Hip 1 Ridge Terminal	
<b>Circular Cover Hip &amp; Ridge Trim Group</b>	CC-Hip Starter	CC-Hip	CC-Ridge	CC-Closed Ridge End	CC-2 Hip	1 Ridge Terminal	CC-Low Bump
<b>#102/#206 Hip &amp; Ridge Trim Group</b>	#152 Hip Starter	#102 Hip Roll	#206 Ridge	#206 Closed Ridge End	#102/#206 Hip	2 Hip 1 Ridge Terminal	#405 High Bump #406 High Bump Gable Terminal
<b>Old Style Trim Group</b>	Bonnet Hip Starter*	Bonnet Hip Roll* Aries Hip Plate*	Interlocking Ridge				

\* Roof slope on each intersecting roof plane needs to be identical to use these pieces.

FITTINGS					
PROFILE	10 LONG TOP	11 SHORT TOP	12 END BAND	13 UNDER EAVE	HEADER COURSE
<b>Actual Size</b>	10" x 10 1/2"	10" x 6 1/2"	5" x 15"	10" x 8 1/2"	10" x 15"
<b>Exposure</b>	10" x 6 1/2"	10" x 4 1/2"	5" x 6 1/2"	10"	10" x 12"
<b>Weight</b>	4.2 lbs./pc.	2.6 lbs./pc.	2.9 lbs./pc.	3.4 lbs./pc.	5.8 lbs./pc.

# CRUDE SHINGLE TILE



Chipped corners, rounded butts and a rough stone surface give Ludowici's Crude shingle tile the authenticity and character of an Old Europe appearance. Crude shingle tiles are available in standard and custom matte colors, mists and blends. See the *Colors of Ludowici* brochure for more information about our extensive color program.

## PHYSICAL CHARACTERISTICS

CHARACTERISTIC	CRUDE SHINGLE TILE	PROFILE
Weight Per Square	1935 lbs.	
Pieces Per Square	480 pcs.	
Overall Size	6" x 12" x 5/8"	
Exposure	6" x 5"	
Minimum Slope	5:12	
Color Blends	Available in all standard and custom matte colors. For more information about Ludowici's color program, please see the <i>Colors of Ludowici</i> brochure.	
Base Texture	Stone Also available in custom textures. Please see the <i>Terra Cotta Textures</i> brochure for more information.	

### APPROVALS & CERTIFICATIONS

- ◆ Miami-Dade NOA No: 12-0904.14
- ◆ State of Florida Approval No: FL 13777
- ◆ ASTM C1167 Grade 1 Roof Tile With Water Absorption Less Than 2%
- ◆ Class A Fire Rated
- ◆ IAMPO UES ER-452



### LUDOWICI WARRANTY

All Ludowici tiles are manufactured in the United States and carry a 75-year warranty against color fading and manufacturing defects. For complete warranty details, please visit [www.ludowici.com](http://www.ludowici.com).



Photos are for representation purposes only and should not be used for final product selection. Tiles ordered should be chosen from actual samples available at the time of order. Ludowici reserves the right to alter and adjust products, colors and finishes at any time. Please contact a sales representative for more information.

# CRUDE SHINGLE TILE

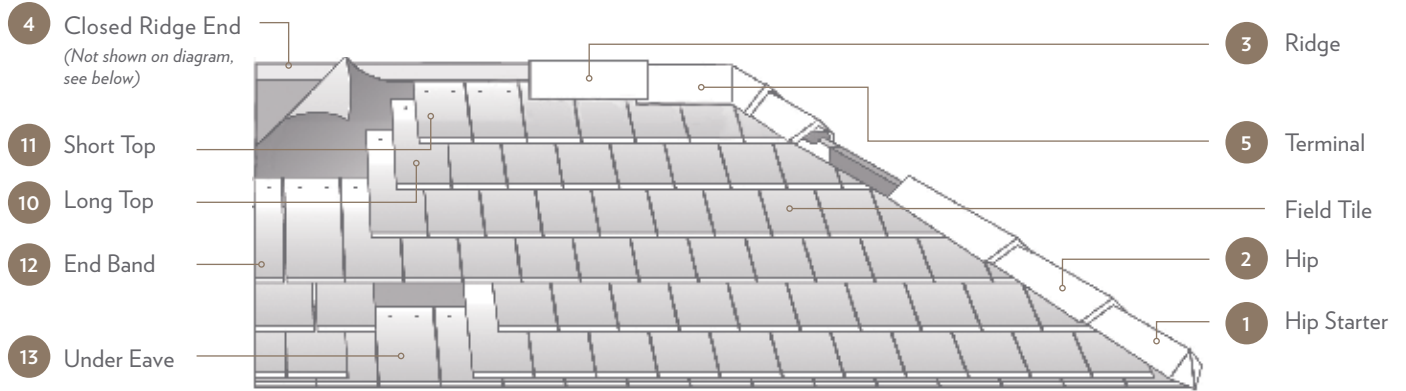

HIP & RIDGE							
Visit <a href="http://www.ludowici.com">www.ludowici.com</a> to download a detailed product sheet on Hip, Ridge and Decorative Hip Starters.							
PROFILE	1 HIP STARTER	2 HIP	3 RIDGE	4 CLOSED RIDGE END	5 TERMINAL		
<b>V-Hip &amp; Ridge Trim Group</b>	V-Hip Starter	V-Hip	V-Ridge	V-Closed Ridge End	V-2 Hip	1 Ridge Terminal	
<b>#118/#211 Hip &amp; Ridge Trim Group</b>	#168 Hip Starter	#118 Hip Roll	#211 Ridge	#211 Closed Ridge End	#118/#211 Hip	2 Hip 1 Ridge Terminal	
<b>Circular Cover Hip &amp; Ridge Trim Group</b>	CC-Hip Starter	CC-Hip	CC-Ridge	CC-Closed Ridge End	CC-2 Hip	1 Ridge Terminal	CC-Low Bump 2 Hip 1 Ridge Terminal
<b>#102/#206 Hip &amp; Ridge Trim Group</b>	#152 Hip Starter	#102 Hip Roll	#206 Ridge	#206 Closed Ridge End	#102/#206 Hip	2 Hip 1 Ridge Terminal	#405 High Bump 2 Hip 1 Ridge Terminal #406 High Bump Gable Terminal
<b>Old Style Trim Group</b>	Bonnet Hip Starter*	Bonnet Hip Roll* Aries Hip Plate*	Interlocking Ridge				

\* Roof slope on each intersecting roof plane needs to be identical to use these pieces.

FITTINGS					
PROFILE	10 LONG TOP	11 SHORT TOP	12 END BAND	13 UNDER EAVE	HEADER COURSE
<b>Actual Size</b>	6" x 9"	6" x 5"	3" x 12"	6" x 7"	6" x 12"
<b>Exposure</b>	6" x 5"	6" x 2"	3" x 5"	6"	6" x 9"
<b>Weight</b>	3.1 lbs./pc.	1.7 lbs./pc.	2.1 lbs./pc.	3.0 lbs./pc.	4.1 lbs./pc.



# GEORGIAN SHINGLE TILE



Georgian shingle tile’s scored wood sawn finish and square bottom edge evokes the texture and character of hand split wood shakes. Georgian tile has a permanent non-fading finish and it will not rot, warp, curl or burn like wood shakes. In addition to the standard 8” width, widths of 9” and 10” can be mixed for a more random appearance. Georgian shingle tiles are available in all standard and custom matte colors, mists and blends offered by Ludowici. See the *Colors of Ludowici* brochure for more information about our extensive color program.

## PHYSICAL CHARACTERISTICS

CHARACTERISTIC	GEORGIAN SHINGLE TILE	PROFILE
Weight Per Square	1600 lbs.	
Pieces Per Square	276 pcs.	
Overall Size	8” x 15” x 1/2”	
Exposure	8” x 6 1/2”	
Minimum Slope	5:12	
Color Blends	Available in all standard and custom matte colors. For more information about Ludowici’s color program, please see the <i>Colors of Ludowici</i> brochure.	
Base Texture	Georgian Scoring Also available in custom textures.* Please see the <i>Terra Cotta Textures</i> brochure for more information.	

### APPROVALS & CERTIFICATIONS

- ◆ Miami-Dade NOA No: 12-0904.14
- ◆ State of Florida Approval No: FL 13777
- ◆ ASTM C1167 Grade 1 Roof Tile With Water Absorption Less Than 2%
- ◆ Class A Fire Rated
- ◆ IAMPO UES ER-452



### LUDOWICI WARRANTY

All Ludowici tiles are manufactured in the United States and carry a 75-year warranty against color fading and manufacturing defects. For complete warranty details, please visit [www.ludowici.com](http://www.ludowici.com).



\* Textures available include brushed butt, battered butt, top sand and other scoring options. Similar tile profiles available in additional textures. Please see a sales representative for more details.

Photos are for representation purposes only and should not be used for final product selection. Tiles ordered should be chosen from actual samples available at the time of order. Ludowici reserves the right to alter and adjust products, colors and finishes at any time. Please contact a sales representative for more information.

# GEORGIAN SHINGLE TILE

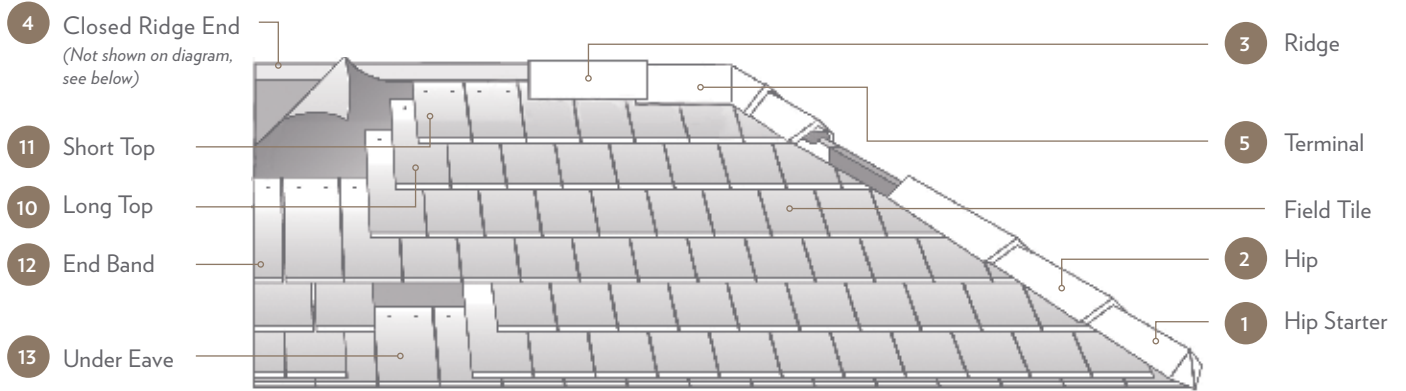

HIP & RIDGE							
Visit <a href="http://www.ludowici.com">www.ludowici.com</a> to download a detailed product sheet on Hip, Ridge and Decorative Hip Starters.							
PROFILE	1 HIP STARTER	2 HIP	3 RIDGE	4 CLOSED RIDGE END	5 TERMINAL		
V-Hip & Ridge Trim Group	V-Hip Starter	V-Hip	V-Ridge	V-Closed Ridge End	V-2 Hip	1 Ridge Terminal	
#118/#211 Hip & Ridge Trim Group	#168 Hip Starter	#118 Hip Roll	#211 Ridge	#211 Closed Ridge End	#118/#211 Hip	2 Hip 1 Ridge Terminal	
Circular Cover Hip & Ridge Trim Group	CC-Hip Starter	CC-Hip	CC-Ridge	CC-Closed Ridge End	CC-2 Hip	1 Ridge Terminal	CC-Low Bump
#102/#206 Hip & Ridge Trim Group	#152 Hip Starter	#102 Hip Roll	#206 Ridge	#206 Closed Ridge End	#102/#206 Hip	2 Hip 1 Ridge Terminal	#405 High Bump #406 High Bump Gable Terminal
Old Style Trim Group	Bonnet Hip Starter*	Bonnet Hip Roll* Aries Hip Plate*	Interlocking Ridge				

\* Roof slope on each intersecting roof plane needs to be identical to use these pieces.

FITTINGS					
PROFILE	10 LONG TOP	11 SHORT TOP	12 END BAND	13 UNDER EAVE	HEADER COURSE
Actual Size	8" x 10 1/2"	8" x 6 1/2"	4" x 15"	8" x 8 1/2"	8" x 15"
Exposure	8" x 6 1/2"	8" x 4 1/2"	4" x 6 1/2"	8"	8" x 12"
Weight	4.2 lbs./pc.	2.6 lbs./pc.	2.9 lbs./pc.	3.4 lbs./pc.	5.8 lbs./pc.

# NORMAN SHINGLE TILE



Ludowici's Norman shingle tile with a cratered surface, black-sanded finish and rough bottom edge has the look and character of centuries old roof tiles from the Normandy region of France. Norman shingle tiles typically feature Santiago Rose glaze with a black sand accent, but may be customized for your project's aesthetic. Norman shingle tiles are backed with the Ludowici 75-year material warranty, including color.

## PHYSICAL CHARACTERISTICS

CHARACTERISTIC	NORMAN SHINGLE TILE	PROFILE
Weight Per Square	1600 lbs.	
Pieces Per Square	317 pcs.	
Overall Size	7" x 15" x 1/2"	
Exposure	7" x 6 1/2"	
Minimum Slope	5:12	
Color Blends	Santiago Rose with Black Sand Also available in other standard and custom matte colors. For more information about Ludowici's color program, please see the <i>Colors of Ludowici</i> brochure.	
Base Texture	Dimpled and Hand Sanded Also available in custom textures. Please see the <i>Terra Cotta Textures</i> brochure for more information.	

## APPROVALS & CERTIFICATIONS

- ◆ Miami-Dade NOA No: 12-0904.14
- ◆ State of Florida Approval No: FL 13777
- ◆ ASTM C1167 Grade 1 Roof Tile With Water Absorption Less Than 2%
- ◆ Class A Fire Rated
- ◆ IAMPO UES ER-452



## LUDOWICI WARRANTY

All Ludowici tiles are manufactured in the United States and carry a 75-year warranty against color fading and manufacturing defects. For complete warranty details, please visit [www.ludowici.com](http://www.ludowici.com).



Photos are for representation purposes only and should not be used for final product selection. Tiles ordered should be chosen from actual samples available at the time of order. Ludowici reserves the right to alter and adjust products, colors and finishes at any time. Please contact a sales representative for more information.

# NORMAN SHINGLE TILE

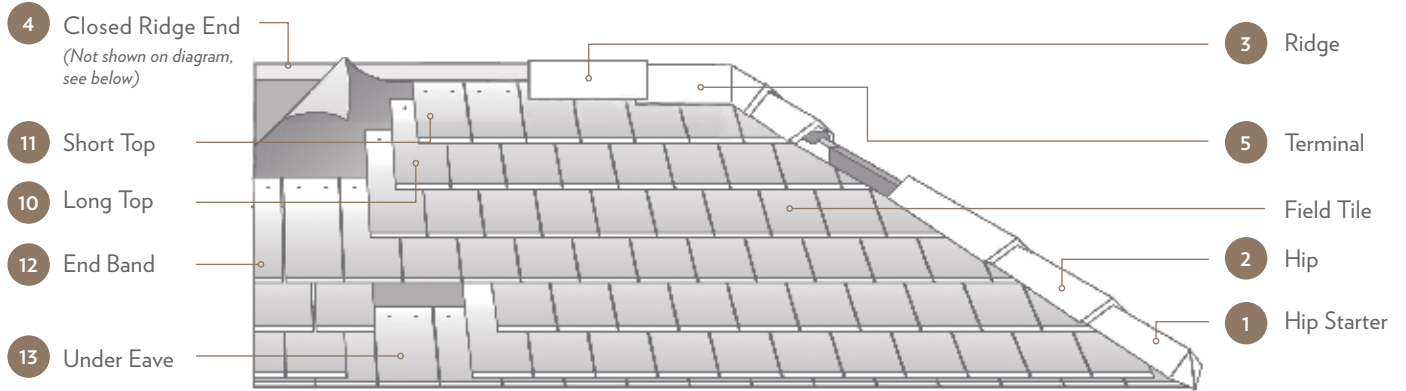

HIP & RIDGE							
Visit <a href="http://www.ludowici.com">www.ludowici.com</a> to download a detailed product sheet on Hip, Ridge and Decorative Hip Starters.							
PROFILE	1 HIP STARTER	2 HIP	3 RIDGE	4 CLOSED RIDGE END	5 TERMINAL		
<b>V-Hip &amp; Ridge Trim Group</b>	V-Hip Starter	V-Hip	V-Ridge	V-Closed Ridge End	V-2 Hip	1 Ridge Terminal	
<b>#118/#211 Hip &amp; Ridge Trim Group</b>	#168 Hip Starter	#118 Hip Roll	#211 Ridge	#211 Closed Ridge End	#118/#211 Hip	2 Hip 1 Ridge Terminal	
<b>Circular Cover Hip &amp; Ridge Trim Group</b>	CC-Hip Starter	CC-Hip	CC-Ridge	CC-Closed Ridge End	CC-2 Hip	1 Ridge Terminal	CC-Low Bump 2 Hip 1 Ridge Terminal
<b>#102/#206 Hip &amp; Ridge Trim Group</b>	#152 Hip Starter	#102 Hip Roll	#206 Ridge	#206 Closed Ridge End	#102/#206 Hip	2 Hip 1 Ridge Terminal	#405 High Bump 2 Hip 1 Ridge Terminal #406 High Bump Gable Terminal
<b>Old Style Trim Group</b>	Bonnet Hip Starter*	Bonnet Hip Roll* Aries Hip Plate*	Interlocking Ridge				

\* Roof slope on each intersecting roof plane needs to be identical to use these pieces.

FITTINGS					
PROFILE	10 LONG TOP	11 SHORT TOP	12 END BAND	13 UNDER EAVE	HEADER COURSE
<b>Actual Size</b>	7" x 10 1/2"	7" x 6 1/2"	3 1/2" x 15"	7" x 8 1/2"	7" x 15"
<b>Exposure</b>	7" x 6 1/2"	7" x 4 1/2"	3 1/2" x 6 1/2"	7"	7" x 12"
<b>Weight</b>	4.2 lbs./pc.	2.6 lbs./pc.	2.5 lbs./pc.	3.4 lbs./pc.	5.0 lbs./pc.

# PROVINCIAL SHINGLE TILE



Ludowici's Provincial shingle tile has a glare reducing fine machine scored surface and a beveled butt providing a clean elegant look suitable for all architectural styles. Provincial shingle tiles are available in standard and custom matte colors, mists and blends. See the *Colors of Ludowici* brochure for more information about our extensive color program.

## PHYSICAL CHARACTERISTICS

CHARACTERISTIC	PROVINCIAL SHINGLE TILE	PROFILE
Weight Per Square	1575 lbs.	
Pieces Per Square	317 pcs.	
Overall Size	7" x 15" x 1/2"	
Exposure	7" x 6 1/2"	
Minimum Slope	5:12	
Color Blends	Available in all standard and custom matte colors. For more information about Ludowici's color program, please see the <i>Colors of Ludowici</i> brochure.	
Base Texture	Fine Machine Score Also available in custom textures. Please see the <i>Terra Cotta Textures</i> brochure for more information.	

### APPROVALS & CERTIFICATIONS

- ◆ Miami-Dade NOA No: 12-0904.14
- ◆ State of Florida Approval No: FL 13777
- ◆ ASTM C1167 Grade 1 Roof Tile With Water Absorption Less Than 2%
- ◆ Class A Fire Rated
- ◆ IAMPO UES ER-452



### LUDOWICI WARRANTY

All Ludowici tiles are manufactured in the United States and carry a 75-year warranty against color fading and manufacturing defects. For complete warranty details, please visit [www.ludowici.com](http://www.ludowici.com).



Photos are for representation purposes only and should not be used for final product selection. Tiles ordered should be chosen from actual samples available at the time of order. Ludowici reserves the right to alter and adjust products, colors and finishes at any time. Please contact a sales representative for more information.

# PROVINCIAL SHINGLE TILE

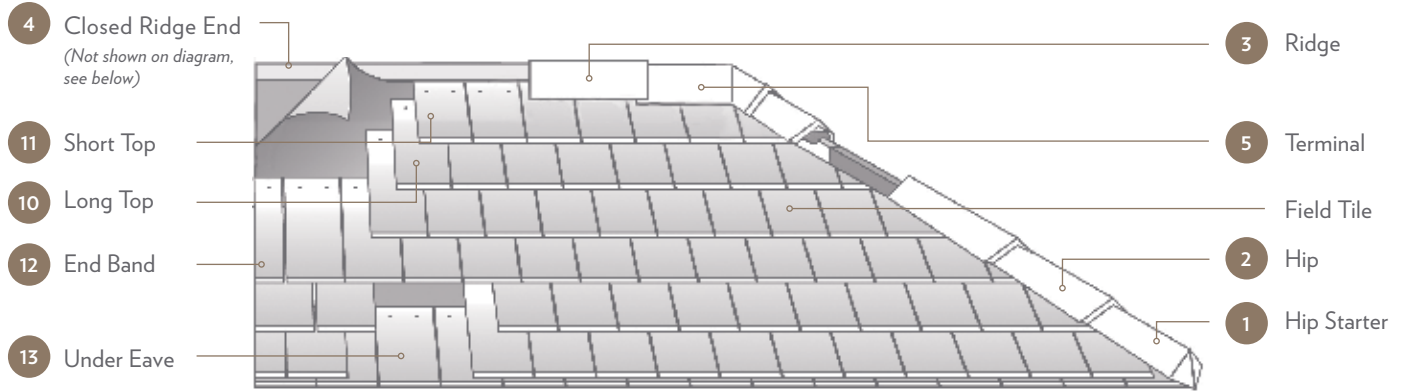

HIP & RIDGE							
Visit <a href="http://www.ludowici.com">www.ludowici.com</a> to download a detailed product sheet on Hip, Ridge and Decorative Hip Starters.							
PROFILE	1 HIP STARTER	2 HIP	3 RIDGE	4 CLOSED RIDGE END	5 TERMINAL		
<b>V-Hip &amp; Ridge Trim Group</b>	V-Hip Starter	V-Hip	V-Ridge	V-Closed Ridge End	V-2 Hip	1 Ridge Terminal	
<b>#118/#211 Hip &amp; Ridge Trim Group</b>	#168 Hip Starter	#118 Hip Roll	#211 Ridge	#211 Closed Ridge End	#118/#211 Hip	2 Hip 1 Ridge Terminal	
<b>Circular Cover Hip &amp; Ridge Trim Group</b>	CC-Hip Starter	CC-Hip	CC-Ridge	CC-Closed Ridge End	CC-2 Hip	1 Ridge Terminal	CC-Low Bump
<b>#102/#206 Hip &amp; Ridge Trim Group</b>	#152 Hip Starter	#102 Hip Roll	#206 Ridge	#206 Closed Ridge End	#102/#206 Hip	2 Hip 1 Ridge Terminal	#405 High Bump #406 High Bump Gable Terminal
<b>Old Style Trim Group</b>	Bonnet Hip Starter*	Bonnet Hip Roll* Aries Hip Plate*	Interlocking Ridge				

\* Roof slope on each intersecting roof plane needs to be identical to use these pieces.

FITTINGS					
PROFILE	10 LONG TOP	11 SHORT TOP	12 END BAND	13 UNDER EAVE	HEADER COURSE
<b>Actual Size</b>	7" x 10 1/2"	7" x 6 1/2"	3 1/2" x 15"	7" x 8 1/2"	7" x 15"
<b>Exposure</b>	7" x 6 1/2"	7" x 4 1/2"	3 1/2" x 6 1/2"	7"	7" x 12"
<b>Weight</b>	4.2 lbs./pc.	2.6 lbs./pc.	2.5 lbs./pc.	3.4 lbs./pc.	4.9 lbs./pc.

# RUSTIC COLONIAL SHINGLE TILE



Long irregular lengths and a deep rich grooved texture give Ludowici's Rustic Colonial shingle tile the look and feel of hand split wood shakes used on Early American and Colonial buildings. Rustic Colonial shingle tiles are available in standard and custom matte colors, mists and blends. See the *Colors of Ludowici* brochure for more information about our extensive color program.

## PHYSICAL CHARACTERISTICS

CHARACTERISTIC	RUSTIC COLONIAL SHINGLE TILE	PROFILE
Weight Per Square	1800 lbs.	
Pieces Per Square	310 pcs.	
Overall Size	7 3/8" x 14 5/8" x 5/8"	
Exposure	7 3/8" x 6 5/16"	
Minimum Slope	5:12	
Color Blends	Available in all standard and custom matte colors. For more information about Ludowici's color program, please see the <i>Colors of Ludowici</i> brochure.	
Base Texture	Deep Grooved Bark Also available in custom textures. Please see the <i>Terra Cotta Textures</i> brochure for more information.	

## APPROVALS & CERTIFICATIONS

- ◆ ASTM C1167 Grade 1 Roof Tile With Water Absorption Less Than 2%



## LUDOWICI WARRANTY

All Ludowici tiles are manufactured in the United States and carry a 75-year warranty against color fading and manufacturing defects. For complete warranty details, please visit [www.ludowici.com](http://www.ludowici.com).



Photos are for representation purposes only and should not be used for final product selection. Tiles ordered should be chosen from actual samples available at the time of order. Ludowici reserves the right to alter and adjust products, colors and finishes at any time. Please contact a sales representative for more information.

# RUSTIC COLONIAL SHINGLE TILE

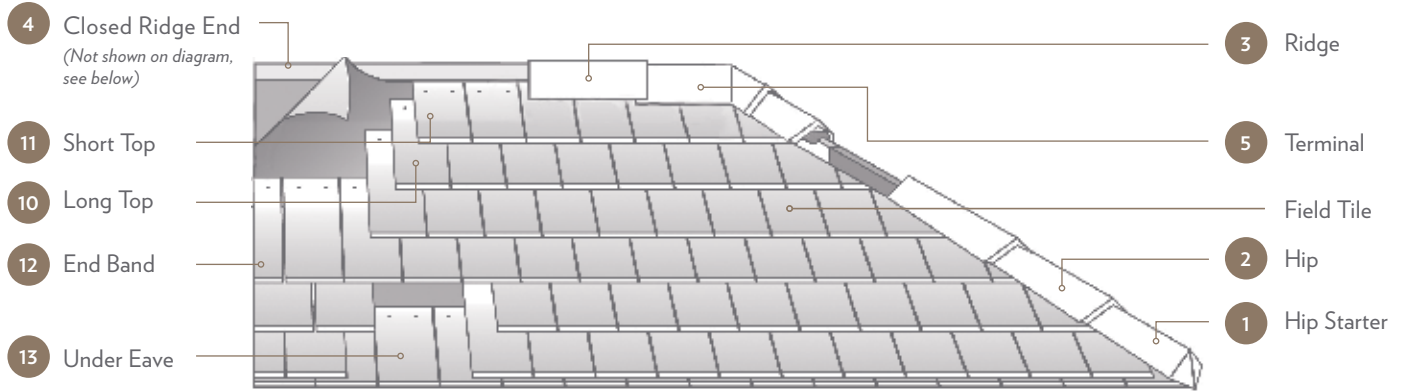

HIP & RIDGE							
Visit <a href="http://www.ludowici.com">www.ludowici.com</a> to download a detailed product sheet on Hip, Ridge and Decorative Hip Starters.							
PROFILE	1 HIP STARTER	2 HIP	3 RIDGE	4 CLOSED RIDGE END	5 TERMINAL		
<b>V-Hip &amp; Ridge Trim Group</b>	V-Hip Starter	V-Hip	V-Ridge	V-Closed Ridge End	V-2 Hip	1 Ridge Terminal	
<b>#118/#211 Hip &amp; Ridge Trim Group</b>	#168 Hip Starter	#118 Hip Roll	#211 Ridge	#211 Closed Ridge End	#118/#211 Hip	2 Hip 1 Ridge Terminal	
<b>Circular Cover Hip &amp; Ridge Trim Group</b>	CC-Hip Starter	CC-Hip	CC-Ridge	CC-Closed Ridge End	CC-2 Hip	1 Ridge Terminal	CC-Low Bump 2 Hip 1 Ridge Terminal
<b>#102/#206 Hip &amp; Ridge Trim Group</b>	#152 Hip Starter	#102 Hip Roll	#206 Ridge	#206 Closed Ridge End	#102/#206 Hip	2 Hip 1 Ridge Terminal	#405 High Bump 2 Hip 1 Ridge Terminal #406 High Bump Gable Terminal
<b>Old Style Trim Group</b>	Bonnet Hip Starter*	Bonnet Hip Roll* Aries Hip Plate*	Interlocking Ridge				

\* Roof slope on each intersecting roof plane needs to be identical to use these pieces.

FITTINGS					
PROFILE	10 LONG TOP	11 SHORT TOP	12 END BAND	13 UNDER EAVE	HEADER COURSE
<b>Actual Size</b>	7 3/8" x 10 1/2"	7 3/8" x 6 1/2"	3 1/2" x 14 5/8"	7 3/8" x 8 1/2"	7 3/8" x 14 5/8"
<b>Exposure</b>	7 3/8" x 6 5/16"	7 3/8" x 3 5/16"	3 1/2" x 6 5/16"	7 3/8"	7 3/8" x 11 5/8"
<b>Weight</b>	4.2 lbs./pc.	2.6 lbs./pc.	2.9 lbs./pc.	3.4 lbs./pc.	5.8 lbs./pc.



# AMERICANA 16" INTERLOCKING TILE



Part of the Legacy Collection, Americana 16" tile features a lightly pressed bark texture and a gently rounded butt. Reminiscent of weathered wood shake, Americana interlocking tile provides a refined yet rustic look to complement a variety of architectural styles. The larger profile means fewer pieces per square and a more economical installation. Americana is also available in a smaller 14" profile. Americana interlocking tiles are available in all standard and custom colors, mists and blends offered by Ludowici. See the *Colors of Ludowici* brochure for more information about our extensive color program.

## PHYSICAL CHARACTERISTICS

CHARACTERISTIC	AMERICANA 16" INTERLOCKING TILE	PROFILE
Weight Per Square	750 lbs.	
Pieces Per Square	109 pcs.	
Overall Size	10 3/4" x 16" x 7/8"	
Exposure	10 1/8" x 13" x 7/8"	
Minimum Slope	3:12	
Color Blends	Available in all standard and custom colors. For more information about Ludowici's color program, please see the <i>Colors of Ludowici</i> brochure.	
Base Texture	Lightly Pressed Bark Also available in custom textures.* Please see the <i>Terra Cotta Textures</i> brochure for more information.	

### APPROVALS & CERTIFICATIONS

- ◆ Miami-Dade NOA No: 13-0430.08
- ◆ State of Florida Approval No: FL 13777
- ◆ ASTM C1167 Grade 1 Roof Tile With Water Absorption Less Than 2%
- ◆ Class A Fire Rated
- ◆ IAMPO UES ER-452

### LUDOWICI WARRANTY

All Ludowici tiles are manufactured in the United States and carry a 75-year warranty against color fading and manufacturing defects. For complete warranty details, please visit [www.ludowici.com](http://www.ludowici.com).



\* Textures available include brushed butt, battered butt and top sand. Similar tile profiles available in additional textures. Please see a sales representative for more details. Photos are for representation purposes only and should not be used for final product selection. Tiles ordered should be chosen from actual samples available at the time of order. Ludowici reserves the right to alter and adjust products, colors and finishes at any time. Please contact a sales representative for more information.

# AMERICANA 16" INTERLOCKING TILE

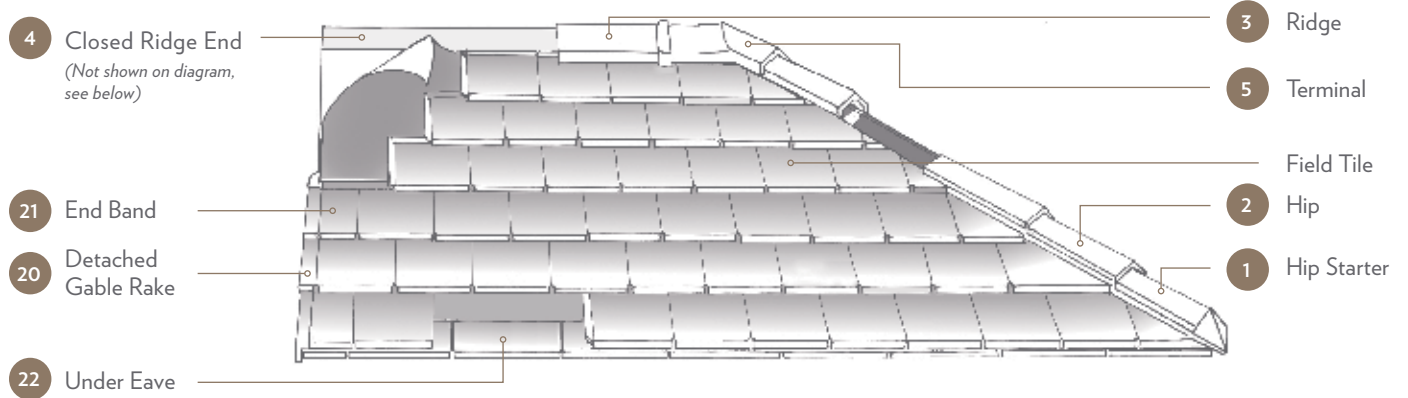

HIP & RIDGE							
Visit <a href="http://www.ludowici.com">www.ludowici.com</a> to download a detailed product sheet on Hip, Ridge and Decorative Hip Starters.							
PROFILE	1 HIP STARTER	2 HIP	3 RIDGE	4 CLOSED RIDGE END	5 TERMINAL		
V-Hip & Ridge Trim Group	V-Hip Starter	V-Hip	V-Ridge	V-Closed Ridge End	V-2 Hip	1 Ridge Terminal	
#118/#211 Hip & Ridge Trim Group	#168 Hip Starter	#118 Hip Roll	#211 Ridge	#211 Closed Ridge End	#118/#211	2 Hip 1 Ridge Terminal	
Circular Cover Hip & Ridge Trim Group	CC-Hip Starter	CC-Hip	CC-Ridge	CC-Closed Ridge End	CC-2 Hip	1 Ridge Terminal	CC-Low Bump 2 Hip 1 Ridge Terminal
#102/#206 Hip & Ridge Trim Group	#152 Hip Starter	#102 Hip Roll	#206 Ridge	#206 Closed Ridge End	#102/#206	2 Hip 1 Ridge Terminal	#405 High Bump 2 Hip 1 Ridge Terminal #406 High Bump Gable Terminal

FITTINGS				
PROFILE	20 DETACHED GABLE RAKE		21 END BAND	22 UNDER EAVE
	Left Rake	Right Rake	End Band	Under Eave
Length	16"		16"	12"
Exposure	13"		13"	12"
Weight	2.8 lbs./pc.		5.5 lbs./pc.	2.3 lbs./pc.

# AMERICANA 14" INTERLOCKING TILE



Part of the Legacy Collection, Americana 14" tile features a lightly pressed bark texture and a gently rounded butt. Reminiscent of weathered wood shake, Americana interlocking tile provides a refined yet rustic look to complement a variety of architectural styles. Americana is also available in a larger 16" profile. Americana interlocking tiles are available in all standard and custom colors, mists and blends offered by Ludowici. See the *Colors of Ludowici* brochure for more information about our extensive color program.

## PHYSICAL CHARACTERISTICS

CHARACTERISTIC	AMERICANA 14" INTERLOCKING TILE	PROFILE
Weight Per Square	800 lbs.	
Pieces Per Square	158 pcs.	
Overall Size	9" x 14" x 7/8"	
Exposure	8 1/4" x 11" x 7/8"	
Minimum Slope	3:12	
Color Blends	Available in all standard and custom colors. For more information about Ludowici's color program, please see the <i>Colors of Ludowici</i> brochure.	
Base Texture	Lightly Pressed Bark Also available in custom textures.* Please see the <i>Terra Cotta Textures</i> brochure for more information.	

### APPROVALS & CERTIFICATIONS

- ◆ Miami-Dade NOA No: 12-0904.14
- ◆ State of Florida Approval No: FL 13777
- ◆ ASTM C1167 Grade 1 Roof Tile With Water Absorption Less Than 2%
- ◆ Class A Fire Rated
- ◆ IAMPO UES ER-452

### LUDOWICI WARRANTY

All Ludowici tiles are manufactured in the United States and carry a 75-year warranty against color fading and manufacturing defects. For complete warranty details, please visit [www.ludowici.com](http://www.ludowici.com).



\* Textures available include brushed butt, battered butt and top sand. Similar tile profiles available in additional textures. Please see a sales representative for more details.

Photos are for representation purposes only and should not be used for final product selection. Tiles ordered should be chosen from actual samples available at the time of order. Ludowici reserves the right to alter and adjust products, colors and finishes at any time. Please contact a sales representative for more information.

# AMERICANA 14" INTERLOCKING TILE

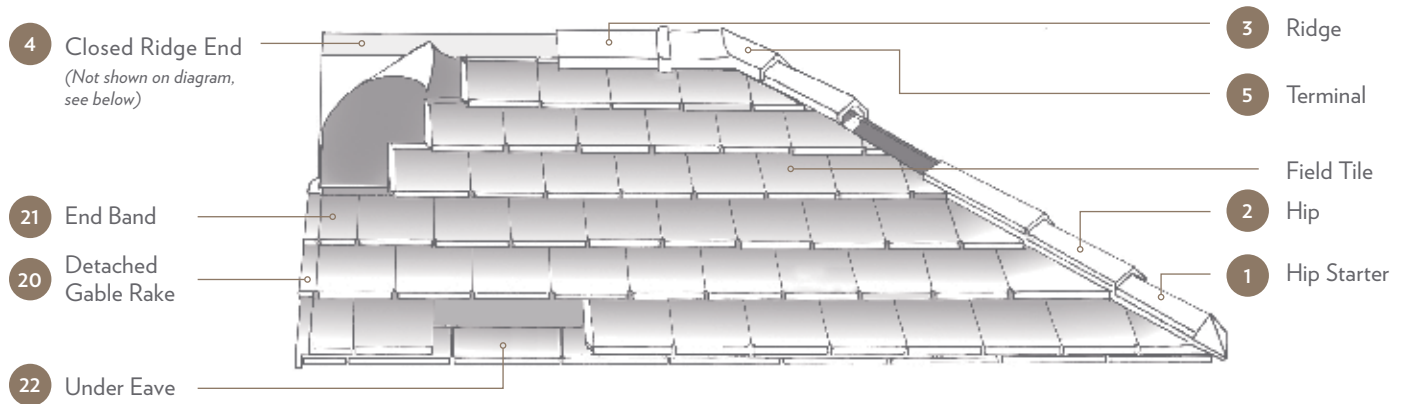

HIP & RIDGE							
Visit <a href="http://www.ludowici.com">www.ludowici.com</a> to download a detailed product sheet on Hip, Ridge and Decorative Hip Starters.							
PROFILE	1 HIP STARTER	2 HIP	3 RIDGE	4 CLOSED RIDGE END	5 TERMINAL		
V-Hip & Ridge Trim Group	V-Hip Starter	V-Hip	V-Ridge	V-Closed Ridge End	V-2 Hip	1 Ridge Terminal	
#118/#211 Hip & Ridge Trim Group	#168 Hip Starter	#118 Hip Roll	#211 Ridge	#211 Closed Ridge End	#118/#211	2 Hip 1 Ridge Terminal	
Circular Cover Hip & Ridge Trim Group	CC-Hip Starter	CC-Hip	CC-Ridge	CC-Closed Ridge End	CC-2 Hip	1 Ridge Terminal	CC-Low Bump 2 Hip 1 Ridge Terminal
#102/#206 Hip & Ridge Trim Group	#152 Hip Starter	#102 Hip Roll	#206 Ridge	#206 Closed Ridge End	#102/#206	2 Hip 1 Ridge Terminal	#405 High Bump 2 Hip 1 Ridge Terminal #406 High Bump Gable Terminal

FITTINGS				
PROFILE	20 DETACHED GABLE RAKE		21 END BAND	22 UNDER EAVE
	Left Rake	Right Rake		
Length	14"		14"	12"
Exposure	11"		11"	12"
Weight	2.0 lbs./pc.		3.3 lbs./pc.	2.3 lbs./pc.

# CENTURY SHAKE®



Century Shake® is a thick profile interlocking terra cotta tile with rugged texture and uneven surface. It's pressed grooves, scratching and rugged butt mirror the appearance of wood shake without all the maintenance. Three different tile sizes create a random width appearance for an even more authentic shake roof look. Available in five popular shake colors as well as custom colors or blends, Century Shake will never fade, rot or curl, ensuring your roof remains as beautiful as the day it was installed for years to come.

## PHYSICAL CHARACTERISTICS

CHARACTERISTIC	CENTURY SHAKE®			PROFILE
Weight Per Square	679 lbs.			
Pieces Per Square	141 pcs. (Full Tile: 100, Two-Thirds Tile: 28, Half Tile: 13)			
Overall Size	5 1/2" x 14 1/2" x 1"	7 3/16" x 14 1/2" x 1"	10 1/2" x 14 1/2" x 1"	
Exposure	5" x 11 1/2"	6 11/16" x 11 1/2"	10" x 11 1/2"	
Minimum Slope	3:12			
Color Blends	Aged Cedar, Earth Gray, Ebony Mist, Sienna, Western Cedar. Also available in all standard and matte color blends. For more information about Ludowici's color program, please see the <i>Colors of Ludowici</i> brochure.			
Base Texture	Scratched Shake			

## APPROVALS & CERTIFICATIONS

- ◆ Miami-Dade NOA No: 15-0820.03
- ◆ State of Florida Approval FL 133777
- ◆ ASTM C1167 Grade 1 Roof Tile With Water Absorption Less Than 2%
- ◆ Class A Fire Rated
- ◆ IAMPO UES ER-452



## LUDOWICI WARRANTY

All Ludowici tiles are manufactured in the United States and carry a 75-year warranty against color fading and manufacturing defects. For complete warranty details, please visit [www.ludowici.com](http://www.ludowici.com).







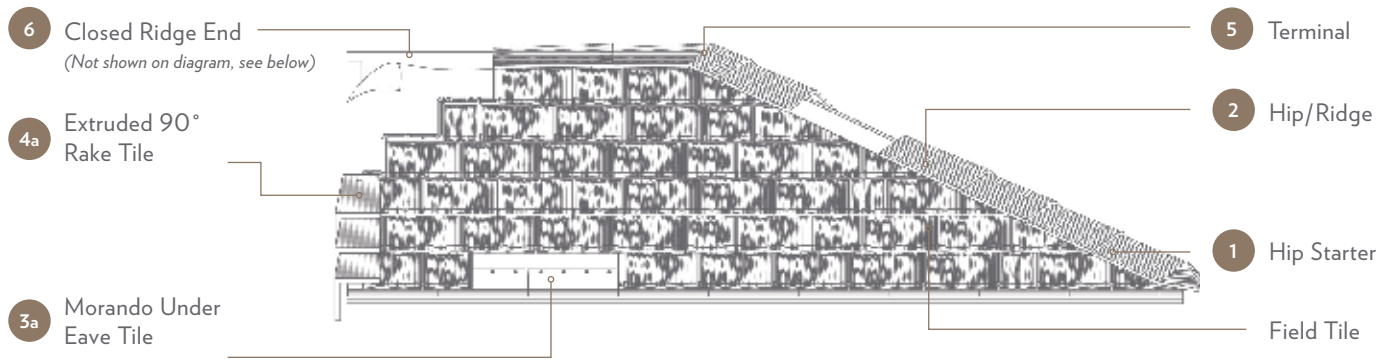

Photos are for representation purposes only and should not be used for final product selection. Tiles ordered should be chosen from actual samples available at the time of order. Ludowici reserves the right to alter and adjust products, colors and finishes at any time. Please contact a sales representative for more information.

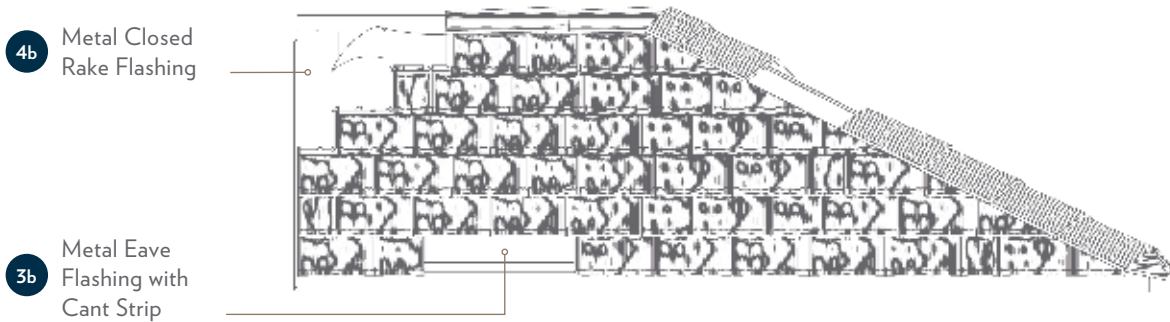
# CENTURY SHAKE®



## ALTERNATE PART OPTIONS (CONSULT INSTALLER FOR AVAILABILITY)



CENTURY SHAKE ACCESSORIES						
AVAILABLE THROUGH LUDOWICI	1	2	3a	4a	5	6
						
	Hip Starter	Hip/Ridge	Morando Under Eave Tile	Extruded 90° Rake Tile	Terminal	Closed Ridge End
NOT AVAILABLE Consult Installer	3b	4b				
						
	Metal Eave Flashing with Cant Strip	Metal Closed Rake Flashing				

Visit [www.ludowici.com](http://www.ludowici.com) to download a detailed product sheet on Hip, Ridge and Decorative Hip Starters.

# CLASSIC 16" INTERLOCKING TILE

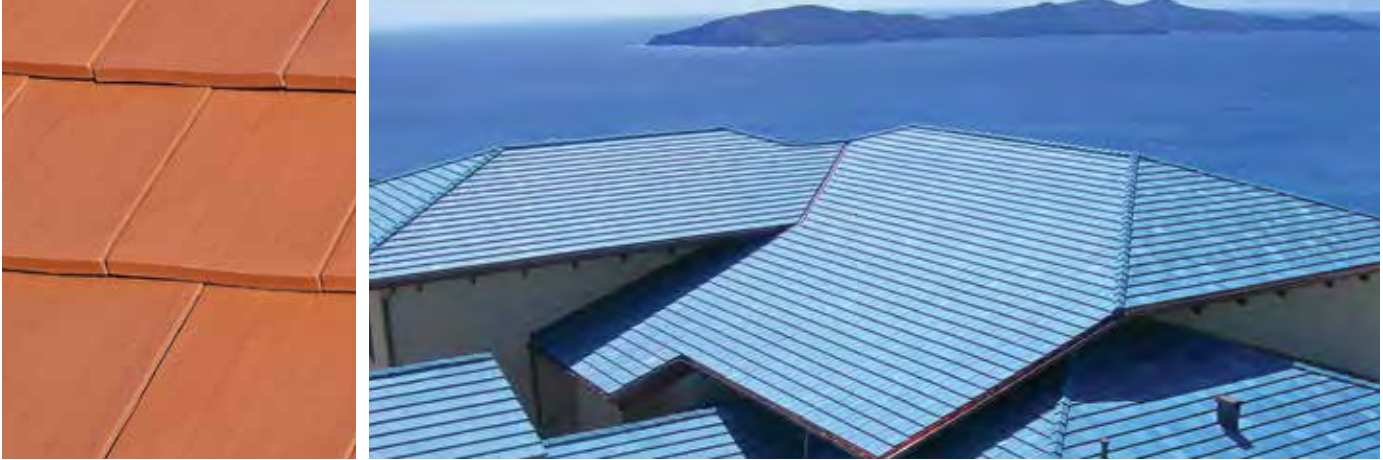

A smooth surface and flat butt give Ludowici's Classic 16" interlocking tile a clean look. The larger size means fewer pieces per square and a more economical installation. Classic interlocking tile is suitable for a full range of architectural styles and can be customized with a number of custom textures\* to fit your design aesthetic. Classic interlocking tiles are available in all standard and custom colors, mists and blends offered by Ludowici. See the *Colors of Ludowici* brochure for more information about our extensive color program.

## PHYSICAL CHARACTERISTICS

CHARACTERISTIC	CLASSIC 16" INTERLOCKING TILE	PROFILE
Weight Per Square	750 lbs.	
Pieces Per Square	109 pcs.	
Overall Size	10 3/4" x 16" x 7/8"	
Exposure	10 1/8" x 13" x 7/8"	
Minimum Slope	3:12	
Color Blends	Available in all standard and custom colors. For more information about Ludowici's color program, please see the <i>Colors of Ludowici</i> brochure.	
Base Texture	Smooth Also available in custom textures.* Please see the <i>Terra Cotta Textures</i> brochure for more information.	

## APPROVALS & CERTIFICATIONS

- ◆ Miami-Dade NOA No: 13-0430.08
- ◆ State of Florida Approval No: FL 13777
- ◆ ASTM C1167 Grade 1 Roof Tile With Water Absorption Less Than 2%
- ◆ Class A Fire Rated
- ◆ IAMPO UES ER-452



## LUDOWICI WARRANTY

All Ludowici tiles are manufactured in the United States and carry a 75-year warranty against color fading and manufacturing defects. For complete warranty details, please visit [www.ludowici.com](http://www.ludowici.com).



\* Textures available include brushed butt, battered butt and top sand. Similar tile profiles available in additional textures. Please see a sales representative for more details.

Photos are for representation purposes only and should not be used for final product selection. Tiles ordered should be chosen from actual samples available at the time of order. Ludowici reserves the right to alter and adjust products, colors and finishes at any time. Please contact a sales representative for more information.

# CLASSIC 16" INTERLOCKING TILE

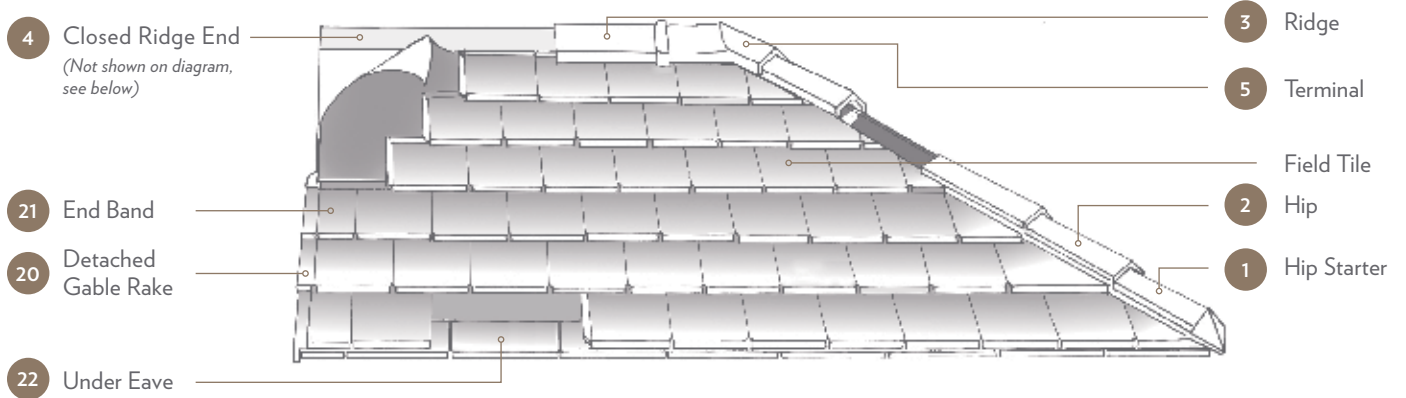

HIP & RIDGE							
Visit <a href="http://www.ludowici.com">www.ludowici.com</a> to download a detailed product sheet on Hip, Ridge and Decorative Hip Starters.							
PROFILE	1 HIP STARTER	2 HIP	3 RIDGE	4 CLOSED RIDGE END	5 TERMINAL		
V-Hip & Ridge Trim Group	V-Hip Starter	V-Hip	V-Ridge	V-Closed Ridge End	V-2 Hip	1 Ridge Terminal	
#118/#211 Hip & Ridge Trim Group	#168 Hip Starter	#118 Hip Roll	#211 Ridge	#211 Closed Ridge End	#118/#211	2 Hip 1 Ridge Terminal	
Circular Cover Hip & Ridge Trim Group	CC-Hip Starter	CC-Hip	CC-Ridge	CC-Closed Ridge End	CC-2 Hip	1 Ridge Terminal	CC-Low Bump 2 Hip 1 Ridge Terminal
#102/#206 Hip & Ridge Trim Group	#152 Hip Starter	#102 Hip Roll	#206 Ridge	#206 Closed Ridge End	#102/#206	2 Hip 1 Ridge Terminal	#405 High Bump 2 Hip 1 Ridge Terminal #406 High Bump Gable Terminal

FITTINGS				
PROFILE	20 DETACHED GABLE RAKE		21 END BAND	22 UNDER EAVE
	Left Rake	Right Rake		
Length	16"		16"	12"
Exposure	13"		13"	12"
Weight	2.8 lbs./pc.		5.5 lbs./pc.	2.3 lbs./pc.



# CLASSIC 14" INTERLOCKING TILE



A smooth surface and flat butt give Ludowici's Classic 14" interlocking tile a clean look. Classic interlocking tile is suitable for a full range of architectural styles and can be customized with a number of custom textures\* to fit your design aesthetic. Classic 14" interlocking tiles are available in all standard and custom colors, mists and blends offered by Ludowici. See the *Colors of Ludowici* brochure for more information about our extensive color program.

Classic interlocking tile is also available in a larger 16" profile.

## PHYSICAL CHARACTERISTICS

CHARACTERISTIC	CLASSIC 14" INTERLOCKING TILE	PROFILE
Weight Per Square	800 lbs.	
Pieces Per Square	158 pcs.	
Overall Size	9" x 14" x 7/8"	
Exposure	8 1/4" x 11" x 7/8"	
Minimum Slope	3:12	
Color Blends	Available in all standard and custom colors. For more information about Ludowici's color program, please see the <i>Colors of Ludowici</i> brochure.	
Base Texture	Smooth Also available in custom textures.* Please see the <i>Terra Cotta Textures</i> brochure for more information.	

## APPROVALS & CERTIFICATIONS

- ◆ Miami-Dade NOA No: 12-0904.14
- ◆ State of Florida Approval No: FL 13777
- ◆ ASTM C1167 Grade 1 Roof Tile With Water Absorption Less Than 2%
- ◆ Class A Fire Rated
- ◆ IAMPO UES ER-452

## LUDOWICI WARRANTY

All Ludowici tiles are manufactured in the United States and carry a 75-year warranty against color fading and manufacturing defects. For complete warranty details, please visit [www.ludowici.com](http://www.ludowici.com).



# CLASSIC 14" INTERLOCKING TILE

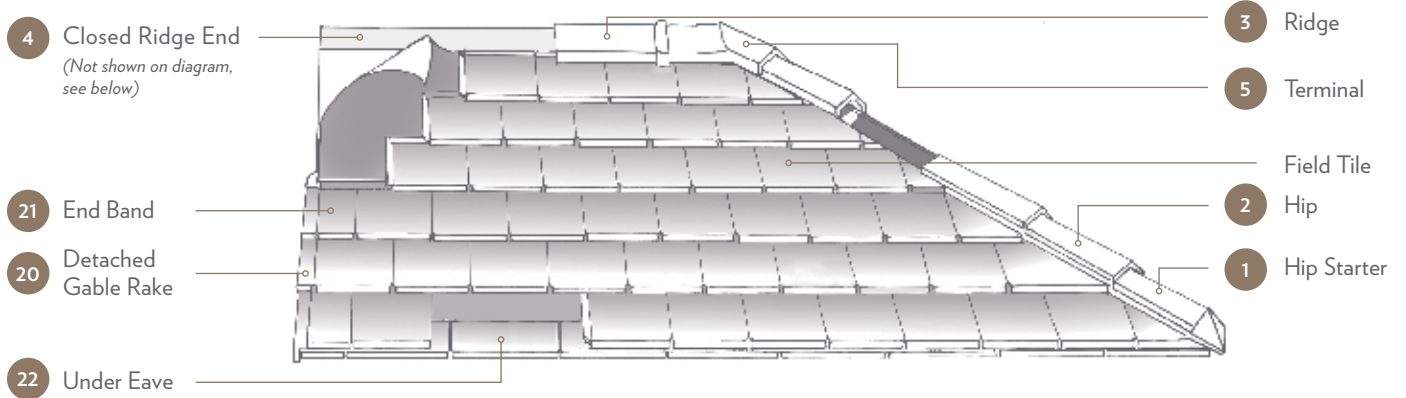

HIP & RIDGE							
Visit <a href="http://www.ludowici.com">www.ludowici.com</a> to download a detailed product sheet on Hip, Ridge and Decorative Hip Starters.							
PROFILE	1 HIP STARTER	2 HIP	3 RIDGE	4 CLOSED RIDGE END	5 TERMINAL		
V-Hip & Ridge Trim Group	V-Hip Starter	V-Hip	V-Ridge	V-Closed Ridge End	V-2 Hip	1 Ridge Terminal	
#118/#211 Hip & Ridge Trim Group	#168 Hip Starter	#118 Hip Roll	#211 Ridge	#211 Closed Ridge End	#118/#211 2 Hip 1 Ridge Terminal		
Circular Cover Hip & Ridge Trim Group	CC-Hip Starter	CC-Hip	CC-Ridge	CC-Closed Ridge End	CC-2 Hip	CC-Low Bump	2 Hip 1 Ridge Terminal
#102/#206 Hip & Ridge Trim Group	#152 Hip Starter	#102 Hip Roll	#206 Ridge	#206 Closed Ridge End	#102/#206 2 Hip 1 Ridge Terminal	#405 High Bump	#406 High Bump Gable Terminal

FITTINGS				
PROFILE	20 DETACHED GABLE RAKE		21 END BAND	22 UNDER EAVE
	Left Rake	Right Rake		
Length	14"		14"	12"
Exposure	11"		11"	12"
Weight	2.0 lbs./pc.		3.3 lbs./pc.	2.3 lbs./pc.

\* Textures available include brushed butt, battered butt and top sand. Similar tile profiles available in additional textures. Please see a sales representative for more details. Photos are for representation purposes only and should not be used for final product selection. Tiles ordered should be chosen from actual samples available at the time of order. Ludowici reserves the right to alter and adjust products, colors and finishes at any time. Please contact a sales representative for more information.

# FRENCH INTERLOCKING TILE



Introduced in the 1890s, Ludowici’s French low profile interlocking tile is a favorite of discriminating architects and one of the most sculptured and dimensional products in our product offering. Large and durable, French terra cotta tile has deep locks on all four sides, plus two prominent flutes on the surface for both a dramatic aesthetic and superior drainage. When applied to a roof, these flutes produce a shadow effect for a highly refined, distinctive appearance.

## PHYSICAL CHARACTERISTICS

CHARACTERISTIC	FRENCH INTERLOCKING TILE	PROFILE
Weight Per Square	1025 lbs.	
Pieces Per Square	133 pcs.	
Overall Size	9" x 16 1/4"	
Exposure	8 1/8" x 13 3/8"	
Minimum Slope	3:12	
Color Blends	Available in most standard and custom colors.* For more information about Ludowici’s color program, please see the <i>Colors of Ludowici</i> brochure.	
Base Texture	Smooth Also available in custom textures.* Please see the <i>Terra Cotta Textures</i> brochure for more information.	

## APPROVALS & CERTIFICATIONS

- ◆ Miami-Dade NOA No: 12-0904.16
- ◆ State of Florida Approval No: FL 13777
- ◆ ASTM C1167 Grade 1 Roof Tile With Water Absorption Less Than 2%
- ◆ Class A Fire Rated
- ◆ IAMPO UES ER-452



## LUDOWICI WARRANTY

All Ludowici tiles are manufactured in the United States and carry a 75-year warranty against color fading and manufacturing defects. For complete warranty details, please visit [www.ludowici.com](http://www.ludowici.com).



\* Excluding Impressionist Color Series. Textures available include top sand and weathered. Please see a sales representative for more details.

Photos are for representation purposes only and should not be used for final product selection. Tiles ordered should be chosen from actual samples available at the time of order. Ludowici reserves the right to alter and adjust products, colors and finishes at any time. Please contact a sales representative for more information.

# FRENCH INTERLOCKING TILE

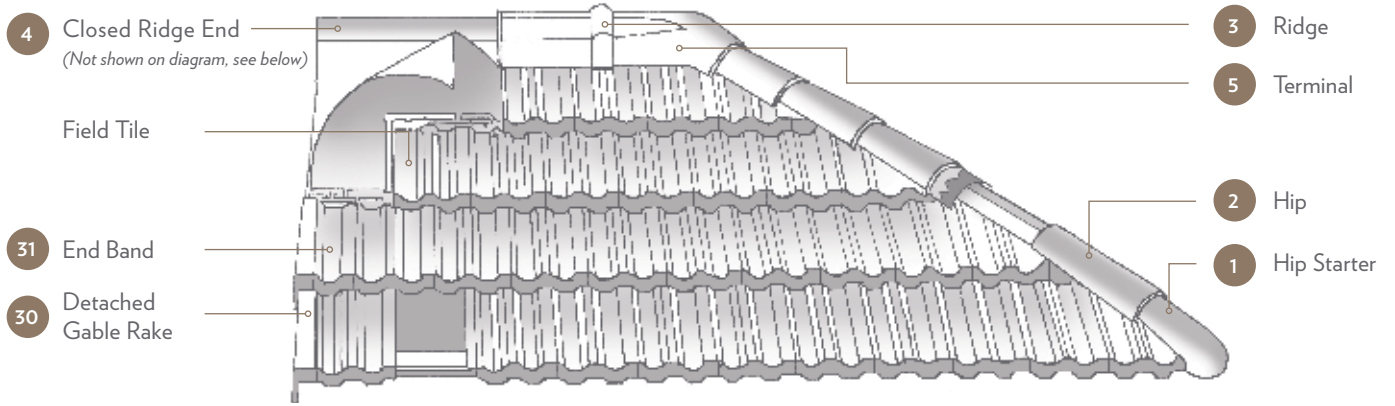

HIP & RIDGE		Visit <a href="http://www.ludowici.com">www.ludowici.com</a> to download a detailed product sheet on Hip, Ridge and Decorative Hip Starters.					
PROFILE	1 HIP STARTER	2 HIP	3 RIDGE	4 CLOSED RIDGE END	5 TERMINAL		
Circular Cover Hip & Ridge Trim Group	CC-Hip Starter	CC-Hip	CC-Ridge	CC-Closed Ridge End	CC-2 Hip 1 Ridge Terminal	CC-Low Bump 2 Hip 1 Ridge Terminal	
#102/#206 Hip & Ridge Trim Group	#152 Hip Starter	#102 Hip Roll	#206 Ridge	#206 Closed Ridge End	#102/#206 2 Hip 1 Ridge Terminal	#405 High Bump 2 Hip 1 Ridge Terminal	#406 High Bump Gable Terminal

FITTINGS		
PROFILE	30 DETACHED GABLE RAKE	31 END BAND
	Left Rake Right Rake	
Length	16 1/4"	16 1/4"
Exposure	13 3/8"	13 3/8"
Weight	2.9 lbs./pc.	5.7 lbs./pc.

# LANAI 16" INTERLOCKING TILE



Ludowici's Lanai 16" interlocking tile has a square butt and a weathered sandblasted surface giving it the aged look and character of centuries old tile. The clean, uniform look complements any architectural style. The larger size means fewer pieces per square and a more economical installation. Lanai is also available in a smaller 14" profile. Lanai tiles are available in all standard and custom colors, mists and blends offered by Ludowici. See the *Colors of Ludowici* brochure for more information about our extensive color program.

## PHYSICAL CHARACTERISTICS

CHARACTERISTIC	LANAI 16" INTERLOCKING TILE	PROFILE
Weight Per Square	750 lbs.	
Pieces Per Square	109 pcs.	
Overall Size	10 3/4" x 16" x 7/8"	
Exposure	10 1/8" x 13" x 7/8"	
Minimum Slope	3:12	
Color Blends	Available in all standard and custom colors. For more information about Ludowici's color program, please see the <i>Colors of Ludowici</i> brochure.	
Base Texture	Weathered Also available in custom textures.* Please see the <i>Terra Cotta Textures</i> brochure for more information.	

### APPROVALS & CERTIFICATIONS

- ◆ Miami-Dade NOA No: 13-0430.08
- ◆ State of Florida Approval No: FL 13777
- ◆ ASTM C1167 Grade 1 Roof Tile With Water Absorption Less Than 2%
- ◆ Class A Fire Rated
- ◆ IAMPO UES ER-452



### LUDOWICI WARRANTY

All Ludowici tiles are manufactured in the United States and carry a 75-year warranty against color fading and manufacturing defects. For complete warranty details, please visit [www.ludowici.com](http://www.ludowici.com).



\* Textures available include brushed butt, battered butt, hand roughed and top sand. Similar tile profiles available in additional textures. Please see a sales representative for more details.

Photos are for representation purposes only and should not be used for final product selection. Tiles ordered should be chosen from actual samples available at the time of order. Ludowici reserves the right to alter and adjust products, colors and finishes at any time. Please contact a sales representative for more information.

# LANAI 16" INTERLOCKING TILE

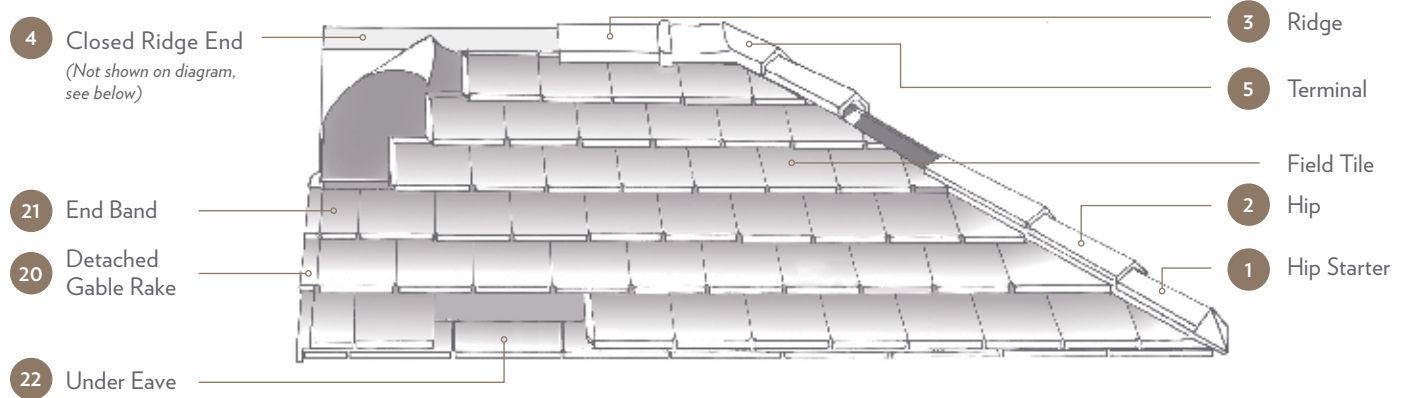

**HIP & RIDGE** Visit [www.ludowici.com](http://www.ludowici.com) to download a detailed product sheet on Hip, Ridge and Decorative Hip Starters.

PROFILE	1 HIP STARTER	2 HIP	3 RIDGE	4 CLOSED RIDGE END	5 TERMINAL		
<b>V-Hip &amp; Ridge Trim Group</b>	V-Hip Starter	V-Hip	V-Ridge	V-Closed Ridge End	V-2 Hip	1 Ridge Terminal	
<b>#118/#211 Hip &amp; Ridge Trim Group</b>	#168 Hip Starter	#118 Hip Roll	#211 Ridge	#211 Closed Ridge End	#118/#211 2 Hip 1 Ridge Terminal		
<b>Circular Cover Hip &amp; Ridge Trim Group</b>	CC-Hip Starter	CC-Hip	CC-Ridge	CC-Closed Ridge End	CC-2 Hip 1 Ridge Terminal	CC-Low Bump 2 Hip 1 Ridge Terminal	
<b>#102/#206 Hip &amp; Ridge Trim Group</b>	#152 Hip Starter	#102 Hip Roll	#206 Ridge	#206 Closed Ridge End	#102/#206 2 Hip 1 Ridge Terminal	#405 High Bump 2 Hip 1 Ridge Terminal	#406 High Bump Gable Terminal

**FITTINGS**

PROFILE	20 DETACHED GABLE RAKE		21 END BAND	22 UNDER EAVE
	Left Rake	Right Rake		
<b>Length</b>	16"		16"	12"
<b>Exposure</b>	13"		13"	12"
<b>Weight</b>	2.8 lbs./pc.		5.5 lbs./pc.	2.3 lbs./pc.

# LANAI 14" INTERLOCKING TILE



Ludowici's Lanai 14" interlocking tile has a square butt and a weathered sandblasted surface giving the aged look and character of centuries old tile. The clean, uniform look complements any architectural style. Lanai is also available in a larger 16" profile. Lanai tiles are available in all standard and custom colors, mists and blends offered by Ludowici. See the *Colors of Ludowici* brochure for more information about our extensive color program.

## PHYSICAL CHARACTERISTICS

CHARACTERISTIC	LANAI 14" INTERLOCKING TILE	PROFILE
Weight Per Square	800 lbs.	
Pieces Per Square	158 pcs.	
Overall Size	9" x 14" x 7/8"	
Exposure	8 1/4" x 11" x 7/8"	
Minimum Slope	3:12	
Color Blends	Available in all standard and custom colors. For more information about Ludowici's color program, please see the <i>Colors of Ludowici</i> brochure.	
Base Texture	Weathered Also available in custom textures.* Please see the <i>Terra Cotta Textures</i> brochure for more information.	

### APPROVALS & CERTIFICATIONS

- ◆ Miami-Dade NOA No: 12-0904.14
- ◆ State of Florida Approval No: FL 13777
- ◆ ASTM C1167 Grade 1 Roof Tile With Water Absorption Less Than 2%
- ◆ Class A Fire Rated
- ◆ IAMPO UES ER-452



### LUDOWICI WARRANTY

All Ludowici tiles are manufactured in the United States and carry a 75-year warranty against color fading and manufacturing defects. For complete warranty details, please visit [www.ludowici.com](http://www.ludowici.com).



\* Textures available include brushed butt, battered butt, hand roughed and top sand. Similar tile profiles available in additional textures. Please see a sales representative for more details.

Photos are for representation purposes only and should not be used for final product selection. Tiles ordered should be chosen from actual samples available at the time of order. Ludowici reserves the right to alter and adjust products, colors and finishes at any time. Please contact a sales representative for more information.

# LANAI 14" INTERLOCKING TILE

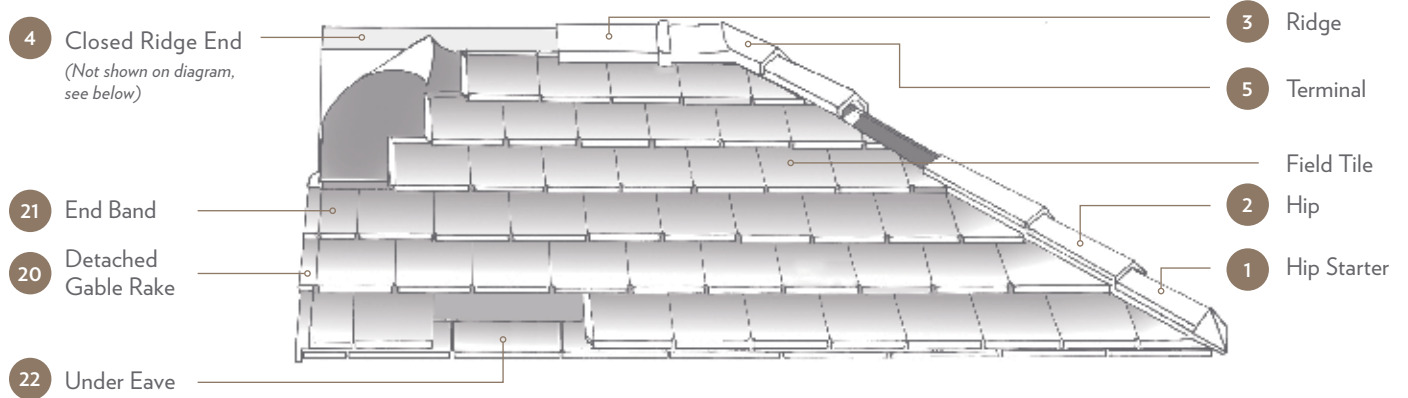

Visit [www.ludowici.com](http://www.ludowici.com) to download a detailed product sheet on Hip, Ridge and Decorative Hip Starters.

PROFILE	1 HIP STARTER	2 HIP	3 RIDGE	4 CLOSED RIDGE END	5 TERMINAL		
<b>V-Hip &amp; Ridge Trim Group</b>	V-Hip Starter	V-Hip	V-Ridge	V-Closed Ridge End	V-2 Hip	1 Ridge Terminal	
<b>#118/#211 Hip &amp; Ridge Trim Group</b>	#168 Hip Starter	#118 Hip Roll	#211 Ridge	#211 Closed Ridge End	#118/#211 Hip	2 Hip 1 Ridge Terminal	
<b>Circular Cover Hip &amp; Ridge Trim Group</b>	CC-Hip Starter	CC-Hip	CC-Ridge	CC-Closed Ridge End	CC-2 Hip	CC-Low Bump	2 Hip 1 Ridge Terminal
<b>#102/#206 Hip &amp; Ridge Trim Group</b>	#152 Hip Starter	#102 Hip Roll	#206 Ridge	#206 Closed Ridge End	#102/#206 Hip	#405 High Bump	#406 High Bump Gable Terminal

PROFILE	20 DETACHED GABLE RAKE		21 END BAND	22 UNDER EAVE
	Left Rake	Right Rake	End Band	Under Eave
<b>Length</b>	14"		14"	12"
<b>Exposure</b>	11"		11"	12"
<b>Weight</b>	2.0 lbs./pc.		3.3 lbs./pc.	2.3 lbs./pc.



# LEXINGTON SLATE®

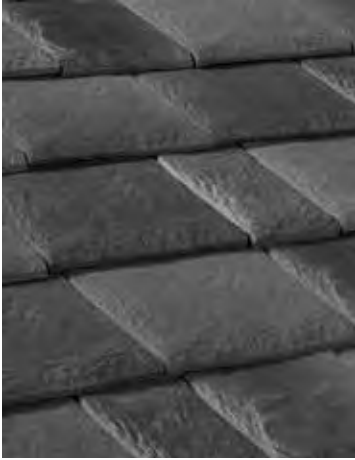

Lexington Slate® is an interlocking terra cotta tile featuring a natural quarried slate texture and is offered in three sizes to create a random width appearance. This slate alternative features all the beauty of natural slate with the enhanced durability and longevity of terra cotta. Lexington Slate is available in our top five most popular slate color blends, as well as custom colors or blends. Unlike other slate alternatives, Lexington Slate will never fade or curl and is Class A fire resistant, easy to install and maintenance-free.

## PHYSICAL CHARACTERISTICS

CHARACTERISTIC	LEXINGTON SLATE®			PROFILE
Weight Per Square	783 lbs.			
Pieces Per Square	152 pcs. (Full Tile: 110, Three-Quarters Tile: 28, Half Tile: 14)			
Overall Size	7 5/8" x 10 1/2" x 1"	11 3/8" x 10 1/2" x 1"	14 3/4" x 10 1/2" x 1"	
Exposure	7" x 7 1/2"	10 1/2" x 7 1/2"	14" x 7 1/2"	
Minimum Slope	3:12			
Color Blends	Brunswick Black, Ebony Mist, Montpelier Green, Slate Gray, Vermont Gray Black Also available in all standard and matte color blends. For more information about Ludowici's color program, please see the <i>Colors of Ludowici</i> brochure.			
Base Texture	Quarried Slate			

### APPROVALS & CERTIFICATIONS

- ◆ Miami-Dade NOA No: 15-1019.01
- ◆ State of Florida Approval FL 13777
- ◆ ASTM C1167 Grade 1 Roof Tile With Water Absorption Less Than 2%
- ◆ Class A Fire Rated
- ◆ IAMPO UES ER-452



### LUDOWICI WARRANTY

All Ludowici tiles are manufactured in the United States and carry a 75-year warranty against color fading and manufacturing defects. For complete warranty details, please visit [www.ludowici.com](http://www.ludowici.com).



Photos are for representation purposes only and should not be used for final product selection. Tiles ordered should be chosen from actual samples available at the time of order. Ludowici reserves the right to alter and adjust products, colors and finishes at any time. Please contact a sales representative for more information.

# LEXINGTON SLATE®

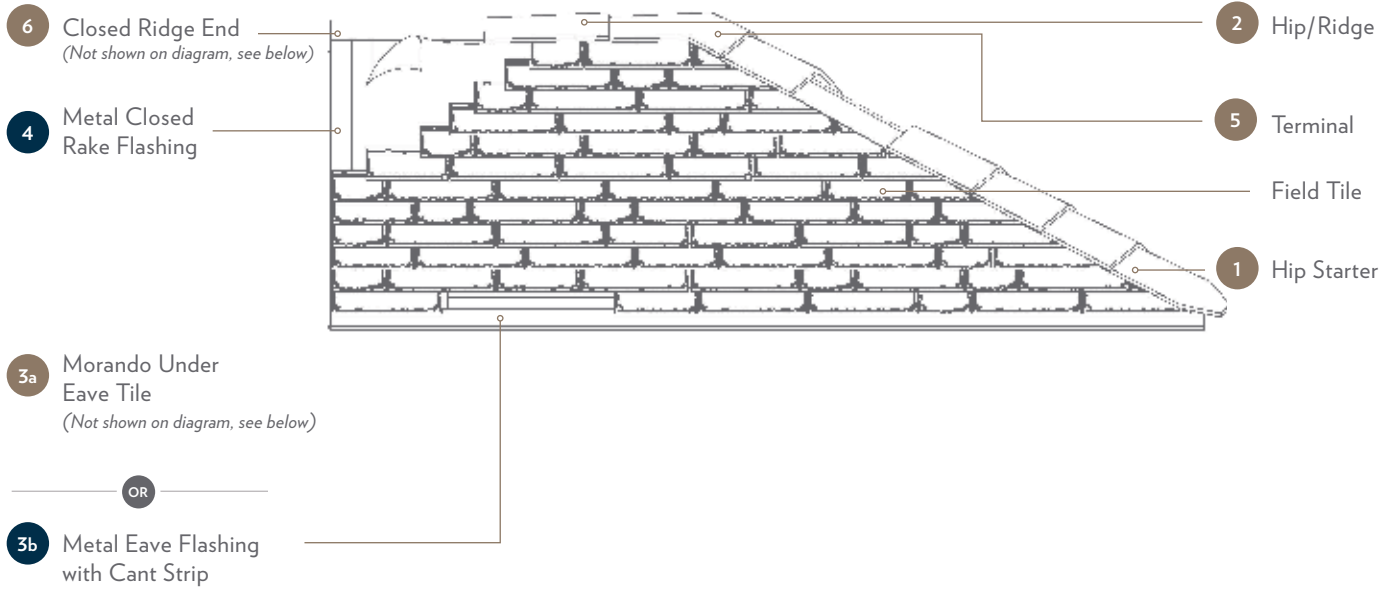

LEXINGTON SLATE ACCESSORIES					
AVAILABLE THROUGH LUDOWICI	1 Hip Starter	2 Hip/Ridge	3a Morando Under Eave Tile	5 Terminal	6 Closed Ridge End
NOT AVAILABLE Consult Installer	3b Metal Eave Flashing with Cant Strip	4b Metal Closed Rake Flashing			

Visit [www.ludowici.com](http://www.ludowici.com) to download a detailed product sheet on Hip, Ridge and Decorative Hip Starters.

# LUDOSHAKE



LudoShake is a lightweight interlocking terra cotta roof tile featuring the texture and varied thickness of hand split wood that can be installed in straight rows or staggered for a more rustic look. Random width tiles are available in LudoShake Premier. Available in six popular shake colors as well as custom colors or blends, LudoShake will never fade, rot or curl. And unlike wood, rubber or plastic shakes, LudoShake tiles are Class A fire resistant, easy to install, maintenance-free and have fewer pieces per square than most alternatives.

## PHYSICAL CHARACTERISTICS

CHARACTERISTIC	LUDOSHAKE	LUDOSHAKE PREMIER			PROFILE
Weight Per Square	598 lbs.	676 lbs.			
Pieces Per Square	111 pcs.	119 pcs. (Full Tile: 100, Two-thirds Tile: 9, Half Tile: 10)			
Overall Size	10 3/4" x 16"	5 3/4" x 16"	7 3/4" x 16"	10 3/4" x 16"	
Exposure	10 1/8" x 13"	5" x 13"	7" x 13"	10 1/8" x 13"	
Minimum Slope	3:12	3:12			
Color Blends	Aged Cedar, Earth Gray, Golden Red Cedar, Sienna, Western Cedar, White Cedar Also available in all standard and custom colors. Please see the <i>Colors of Ludowici</i> brochure for more information.				
Base Texture	Scratched Shake Also available in custom textures. Please see the <i>Terra Cotta Textures</i> brochure for more information.				

## APPROVALS & CERTIFICATIONS

- ◆ Miami-Dade NOA No: 13-0430.08
- ◆ State of Florida Approval No: FL 13777
- ◆ ASTM C1167 Grade 1 Roof Tile With Water Absorption Less Than 2%
- ◆ Class A Fire Rated
- ◆ IAMPO UES ER-452

## LUDOWICI WARRANTY

All Ludowici tiles are manufactured in the United States and carry a 75-year warranty against color fading and manufacturing defects. For complete warranty details, please visit [www.ludowici.com](http://www.ludowici.com).



Photos are for representation purposes only and should not be used for final product selection. Tiles ordered should be chosen from actual samples available at the time of order. Ludowici reserves the right to alter and adjust products, colors and finishes at any time. Please contact a sales representative for more information.

# LUDOSHAKE

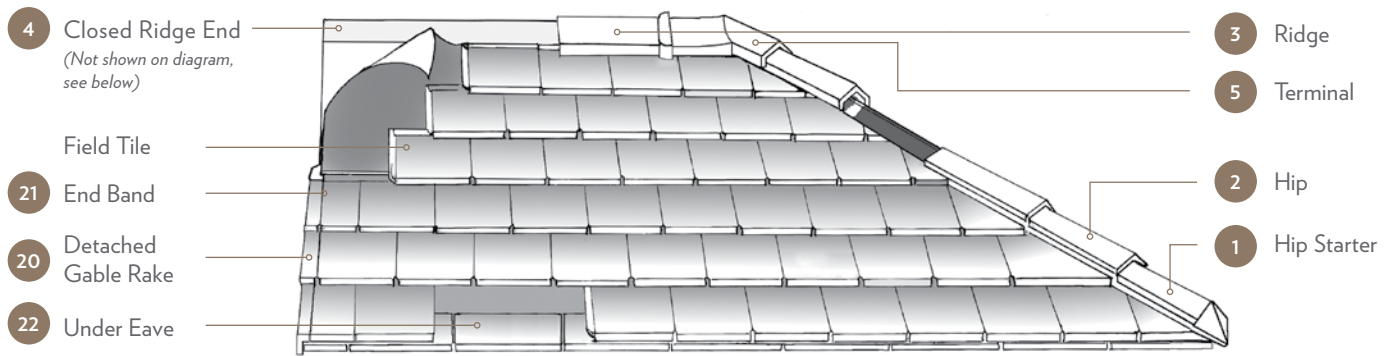

HIP & RIDGE							
Visit <a href="http://www.ludowici.com">www.ludowici.com</a> to download a detailed product sheet on Hip, Ridge and Decorative Hip Starters.							
PROFILE	1 HIP STARTER	2 HIP	3 RIDGE	4 CLOSED RIDGE END	5 TERMINAL		
V-Hip & Ridge Trim Group	V-Hip Starter	V-Hip	V-Ridge	V-Closed Ridge End	V-2 Hip	1 Ridge Terminal	
#118/#211 Hip & Ridge Trim Group	#168 Hip Starter	#118 Hip Roll	#211 Ridge	#211 Closed Ridge End	#118/#211 2 Hip 1 Ridge Terminal		
Circular Cover Hip & Ridge Trim Group	CC-Hip Starter	CC-Hip	CC-Ridge	CC-Closed Ridge End	CC-2 Hip 1 Ridge Terminal	CC-Low Bump 2 Hip 1 Ridge Terminal	
#102/#206 Hip & Ridge Trim Group	#152 Hip Starter	#102 Hip Roll	#206 Ridge	#206 Closed Ridge End	#102/#206 2 Hip 1 Ridge Terminal	#405 High Bump 2 Hip 1 Ridge Terminal	#406 High Bump Gable Terminal

FITTINGS				
PROFILE	20 DETACHED GABLE RAKE		21 END BAND	22 UNDER EAVE
	Left Rake	Right Rake		
Length	16"		16"	12"
Exposure	13"		13"	12"
Weight	2.8 lbs./pc.		5.5 lbs./pc.	2.3 lbs./pc.

# LUDOSLATE



LudoSlate is a lightweight interlocking terra cotta roof tile featuring the texture and chiseled edges of natural slate and can be installed in straight rows or staggered for a more authentic look. Random width tiles are available in LudoSlate Premier. Available in 11 popular slate colors as well as custom colors or blends, LudoSlate will never fade or curl like other slate alternatives. LudoSlate tiles are Class A fire resistant, easy to install and maintenance-free. LudoSlate is a Grade 1 ASTM tile.

## PHYSICAL CHARACTERISTICS

CHARACTERISTIC	LUDOSLATE	LUDOSLATE PREMIER			PROFILE
Weight Per Square	598 lbs.	676 lbs.			
Pieces Per Square	111 pcs.	119 pcs. (Full Tile: 100, Two-thirds Tile: 9, Half Tile: 10)			
Overall Size	10 3/4" x 16"	5 3/4" x 16"	7 3/4" x 16"	10 3/4" x 16"	
Exposure	10 1/8" x 13"	5" x 13"	7" x 13"	10 1/8" x 13"	
Minimum Slope	3:12	3:12			
Color Blends	Antiqued Brunswick Black, Antiqued Montpelier Green, Antiqued Slate Gray, Brunswick Black, Montpelier Green, Mottled Green Purple, Plumstone, Slate Gray, Slate Red, Strata Gray, Vermont Gray Black Also available in all standard and custom colors. Please see the <i>Colors of Ludowici</i> brochure for more information.				
Base Texture	Quarried Slate Also available in custom textures. Please see the <i>Terra Cotta Textures</i> brochure for more information.				

## APPROVALS & CERTIFICATIONS

- ◆ Miami-Dade NOA No: 13-0430.08
- ◆ State of Florida Approval No: FL 13777
- ◆ ASTM C1167 Grade 1 Roof Tile With Water Absorption Less Than 2%
- ◆ Class A Fire Rated
- ◆ IAMPO UES ER-452

## LUDOWICI WARRANTY

All Ludowici tiles are manufactured in the United States and carry a 75-year warranty against color fading and manufacturing defects. For complete warranty details, please visit [www.ludowici.com](http://www.ludowici.com).



# LUDOSLATE

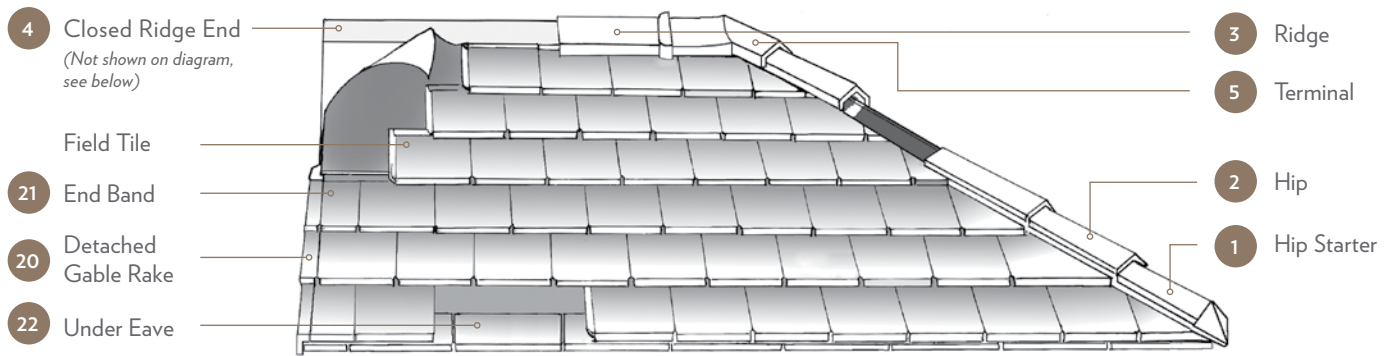

Visit [www.ludowici.com](http://www.ludowici.com) to download a detailed product sheet on Hip, Ridge and Decorative Hip Starters.

PROFILE	1 HIP STARTER	2 HIP	3 RIDGE	4 CLOSED RIDGE END	5 TERMINAL		
<b>V-Hip &amp; Ridge Trim Group</b>	V-Hip Starter	V-Hip	V-Ridge	V-Closed Ridge End	V-2 Hip	1 Ridge Terminal	
<b>#118/#211 Hip &amp; Ridge Trim Group</b>	#168 Hip Starter	#118 Hip Roll	#211 Ridge	#211 Closed Ridge End	#118/#211	2 Hip 1 Ridge Terminal	
<b>Circular Cover Hip &amp; Ridge Trim Group</b>	CC-Hip Starter	CC-Hip	CC-Ridge	CC-Closed Ridge End	CC-2 Hip	1 Ridge Terminal	CC-Low Bump 2 Hip 1 Ridge Terminal
<b>#102/#206 Hip &amp; Ridge Trim Group</b>	#152 Hip Starter	#102 Hip Roll	#206 Ridge	#206 Closed Ridge End	#102/#206	2 Hip 1 Ridge Terminal	#405 High Bump 2 Hip 1 Ridge Terminal #406 High Bump Gable Terminal

PROFILE	20 DETACHED GABLE RAKE		21 END BAND	22 UNDER EAVE
	Left Rake	Right Rake	End Band	Under Eave
<b>Length</b>	16"		16"	12"
<b>Exposure</b>	13"		13"	12"
<b>Weight</b>	2.8 lbs./pc.		5.5 lbs./pc.	2.3 lbs./pc.

Photos are for representation purposes only and should not be used for final product selection. Tiles ordered should be chosen from actual samples available at the time of order. Ludowici reserves the right to alter and adjust products, colors and finishes at any time. Please contact a sales representative for more information.

# WILLIAMSBURG 16" INTERLOCKING TILE



Ludowici's Williamsburg 16" interlocking tile has a scored sawn wood shake texture and a square butt giving it the same texture and character of wood shakes. Williamsburg 16" terra cotta roof tiles have a permanent non-fading finish and will never rot or curl. And unlike wood, rubber or plastic shakes, Williamsburg tiles are Class A fire resistant, easy to install, maintenance-free and have fewer pieces per square than most alternatives. They are Grade 1 ASTM tile and carry Ludowici's 75-year material warranty, so year after year you can enjoy the beauty of a shake-look roof in even the harshest climates. Williamsburg tiles are also available in a smaller 14" profile.

## PHYSICAL CHARACTERISTICS

CHARACTERISTIC	WILLIAMSBURG 16" INTERLOCKING TILE	PROFILE
Weight Per Square	750 lbs.	
Pieces Per Square	109 pcs.	
Overall Size	10 3/4" x 16" x 7/8"	
Exposure	10 1/8" x 13" x 7/8"	
Minimum Slope	3:12	
Color Blends	Available in all standard and custom colors. For more information about Ludowici's color program, please see the <i>Colors of Ludowici</i> brochure.	
Base Texture	Scratched Also available in custom textures.* Please see the <i>Terra Cotta Textures</i> brochure for more information.	

## APPROVALS & CERTIFICATIONS

- ◆ Miami-Dade NOA No: 13-0430.08
- ◆ State of Florida Approval No: FL 13777
- ◆ ASTM C1167 Grade 1 Roof Tile With Water Absorption Less Than 2%
- ◆ Class A Fire Rated
- ◆ IAMPO UES ER-452



## LUDOWICI WARRANTY

All Ludowici tiles are manufactured in the United States and carry a 75-year warranty against color fading and manufacturing defects. For complete warranty details, please visit [www.ludowici.com](http://www.ludowici.com).



# WILLIAMSBURG 16" INTERLOCKING TILE

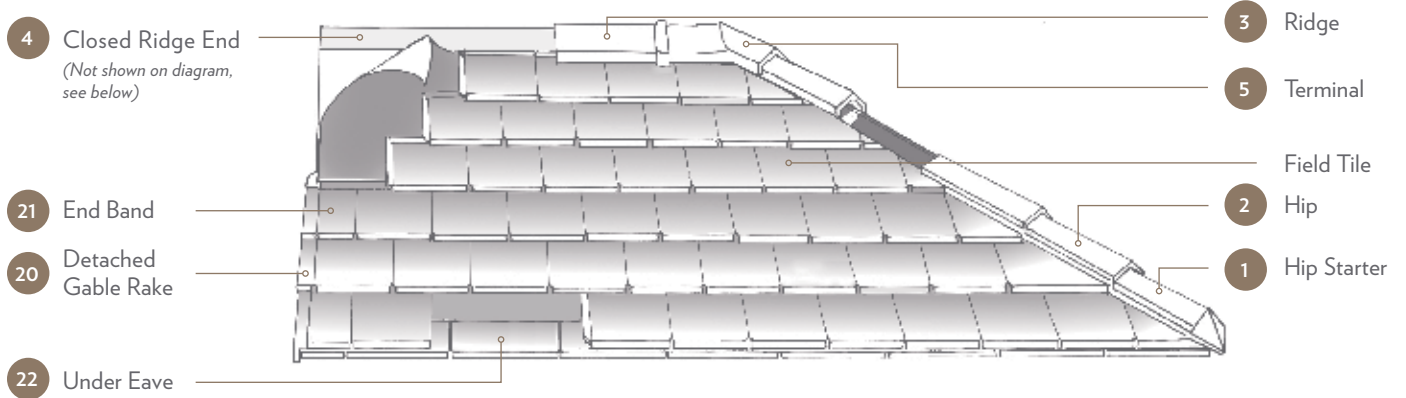

Visit [www.ludowici.com](http://www.ludowici.com) to download a detailed product sheet on Hip, Ridge and Decorative Hip Starters.

HIP & RIDGE							
PROFILE	1 HIP STARTER	2 HIP	3 RIDGE	4 CLOSED RIDGE END	5 TERMINAL		
<b>V-Hip &amp; Ridge Trim Group</b>	V-Hip Starter	V-Hip	V-Ridge	V-Closed Ridge End	V-2 Hip 1 Ridge Terminal		
<b>#118/#211 Hip &amp; Ridge Trim Group</b>	#168 Hip Starter	#118 Hip Roll	#211 Ridge	#211 Closed Ridge End	#118/#211 2 Hip 1 Ridge Terminal		
<b>Circular Cover Hip &amp; Ridge Trim Group</b>	CC-Hip Starter	CC-Hip	CC-Ridge	CC-Closed Ridge End	CC-2 Hip 1 Ridge Terminal	CC-Low Bump 2 Hip 1 Ridge Terminal	
<b>#102/#206 Hip &amp; Ridge Trim Group</b>	#152 Hip Starter	#102 Hip Roll	#206 Ridge	#206 Closed Ridge End	#102/#206 2 Hip 1 Ridge Terminal	#405 High Bump 2 Hip 1 Ridge Terminal	#406 High Bump Gable Terminal

FITTINGS				
PROFILE	20 DETACHED GABLE RAKE		21 END BAND	22 UNDER EAVE
	Left Rake	Right Rake		
<b>Length</b>	16"		16"	12"
<b>Exposure</b>	13"		13"	12"
<b>Weight</b>	2.8 lbs./pc.		5.5 lbs./pc.	2.3 lbs./pc.

\* Textures available include brushed butt, battered butt, top sand and weathered. Similar tile profiles available in additional textures. Please see a sales representative for more details. Photos are for representation purposes only and should not be used for final product selection. Tiles ordered should be chosen from actual samples available at the time of order. Ludowici reserves the right to alter and adjust products, colors and finishes at any time. Please contact a sales representative for more information.



# WILLIAMSBURG 14" INTERLOCKING TILE

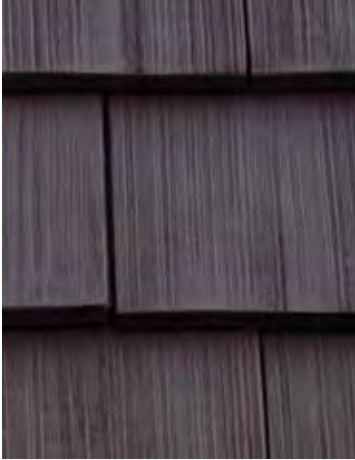

Ludowici's Williamsburg 14" interlocking tile has a scored sawn wood shake texture and a square butt giving it the same texture and character of wood shakes. Williamsburg 14" terra cotta roof tiles have a permanent non-fading finish and will never rot or curl. And unlike wood, rubber or plastic shakes, Williamsburg tiles are Class A fire resistant, easy to install and maintenance-free. They are ASTM Grade 1 tile and carry Ludowici's 75-year material warranty, so year after year you can enjoy the beauty of a shake-look roof in even the harshest climates. Williamsburg is also available in a larger 16" profile.

## PHYSICAL CHARACTERISTICS

CHARACTERISTIC	WILLIAMSBURG 14" INTERLOCKING TILE	PROFILE
Weight Per Square	800 lbs.	
Pieces Per Square	158 pcs.	
Overall Size	9" x 14" x 7/8"	
Exposure	8 1/4" x 11" x 7/8"	
Minimum Slope	3:12	
Color Blends	Available in all standard and custom colors. For more information about Ludowici's color program, please see the <i>Colors of Ludowici</i> brochure.	
Base Texture	Scratched Also available in custom textures.* Please see the <i>Terra Cotta Textures</i> brochure for more information.	

### APPROVALS & CERTIFICATIONS

- ◆ Miami-Dade NOA No: 12-0904.14
- ◆ State of Florida Approval No: FL 13777
- ◆ ASTM C1167 Grade 1 Roof Tile With Water Absorption Less Than 2%
- ◆ Class A Fire Rated
- ◆ IAMPO UES ER-452



### LUDOWICI WARRANTY

All Ludowici tiles are manufactured in the United States and carry a 75-year warranty against color fading and manufacturing defects. For complete warranty details, please visit [www.ludowici.com](http://www.ludowici.com).



\* Textures available include brushed butt, battered butt, top sand and weathered. Similar tile profiles available in additional textures. Please see a sales representative for more details.

Photos are for representation purposes only and should not be used for final product selection. Tiles ordered should be chosen from actual samples available at the time of order. Ludowici reserves the right to alter and adjust products, colors and finishes at any time. Please contact a sales representative for more information.

# WILLIAMSBURG 14" INTERLOCKING TILE

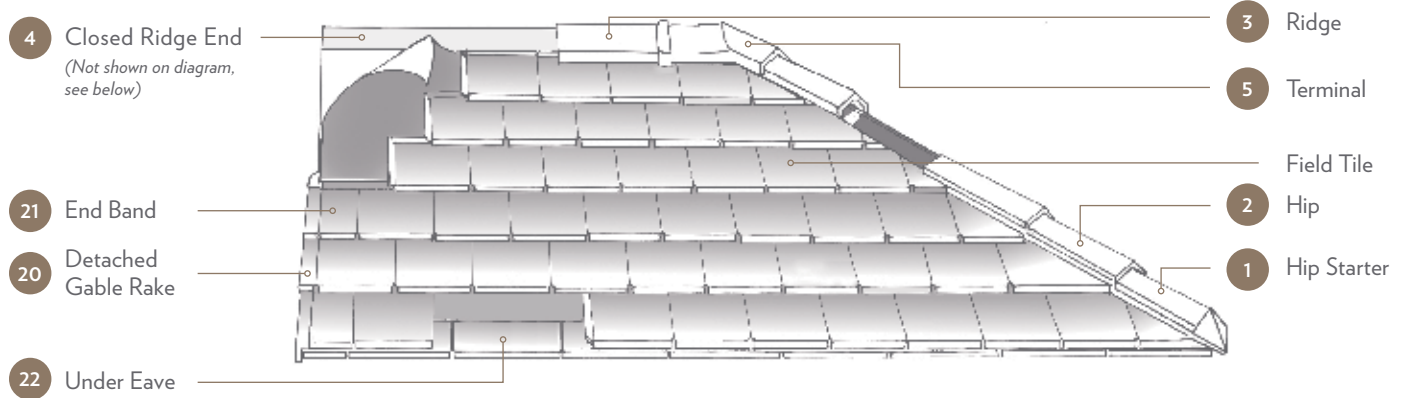

HIP & RIDGE							
Visit <a href="http://www.ludowici.com">www.ludowici.com</a> to download a detailed product sheet on Hip, Ridge and Decorative Hip Starters.							
PROFILE	1 HIP STARTER	2 HIP	3 RIDGE	4 CLOSED RIDGE END	5 TERMINAL		
V-Hip & Ridge Trim Group	V-Hip Starter	V-Hip	V-Ridge	V-Closed Ridge End	V-2 Hip	1 Ridge Terminal	
#118/#211 Hip & Ridge Trim Group	#168 Hip Starter	#118 Hip Roll	#211 Ridge	#211 Closed Ridge End	#118/#211	2 Hip 1 Ridge Terminal	
Circular Cover Hip & Ridge Trim Group	CC-Hip Starter	CC-Hip	CC-Ridge	CC-Closed Ridge End	CC-2 Hip	CC-Low Bump	2 Hip 1 Ridge Terminal
#102/#206 Hip & Ridge Trim Group	#152 Hip Starter	#102 Hip Roll	#206 Ridge	#206 Closed Ridge End	#102/#206	#405 High Bump	#406 High Bump Gable Terminal

FITTINGS				
PROFILE	20 DETACHED GABLE RAKE		21 END BAND	22 UNDER EAVE
	Left Rake	Right Rake	End Band	Under Eave
Length	14"		14"	12"
Exposure	11"		11"	12"
Weight	2.0 lbs./pc.		3.3 lbs./pc.	2.3 lbs./pc.



# ACCESSORIES AND TRIM

Beautifully detailed trim pieces are a signature element of a Ludowici roof. Ludowici offers a wide range of trim, from the stylized ornate #206 and #211 to the clean and simple lines of the V-Hip/Ridge and Circular Covers. Ludowici trim pieces are designed to be compatible with all profiles.

Ludowici also continues to produce numerous historic trim parts as well as custom trim in addition to standard trim parts. Please contact your Ludowici representative for more detailed information regarding your needs.

**#102/#206 TRIM GROUP**  
 Ludowici's signature #102/#206 trim group has been adorning buildings small and large for over 130 years. Combined with Ludowici's High Bump terminals, they make a statement of style and distinction. This is a universal trim group and can be used with all profiles.

HIP STARTER		HIP		RIDGE	
#152 Hip Starter		#102 Hip Roll		#206 Ridge	
				#206 Ridge Vented Type 2 Dormer	
GABLE ENDS			TERMINALS		
Closed Ridge End (starter shown)			#406 Gable Terminal – High Bump; also available with Low Bump (finisher shown)		
		#102/#206 2 Hip 1 Ridge Terminal No Bump (finisher shown)		#102/#206 2 Hip 1 Ridge Terminal Low Bump (finisher shown)	
			#102/#206 2 Hip 1 Ridge Terminal High Bump (finisher shown)		

**CIRCULAR COVER TRIM GROUP**  
 The Circular Cover trim group is a clean simple barrel that is the same part for either a hip or ridge. Used in Europe for centuries, the Circular Cover has an understated elegance that does not distract from the architecture and can be used with all Ludowici profiles.

HIP STARTER		HIP & RIDGE		GABLE END		TERMINALS	
Circular Cover Hip Starter		Circular Cover Hip & Ridge		Circular Cover Closed Ridge End		Circular Cover Terminal 2 Hip 1 Ridge No Bump*	
						Circular Cover Terminal 2 Hip 1 Ridge Low Bump*	

**V-HIP AND RIDGE TRIM GROUP**

V-Hip and Ridge trim is typically used with flat interlocking and shingle tiles. This creates a clean look that can be tailored to match the color, finish and texture of the field tile.

HIP STARTER	HIP & RIDGE		GABLE END	TERMINAL
				
V-Hip Starter	V-Hip	V-Ridge	V-Closed Ridge End	V-2 Hip 1 Ridge Terminal*

**#118/#211 TRIM GROUP**

The 118/#211 trim group has a refined and detailed appearance. Used with any of Ludowici's flat shingle tiles or interlocking tiles, this trim group adds style and character to the clean lines of flat shingle tiles.









HIP STARTER	HIP	RIDGE	GABLE END	TERMINAL
				
#168 Hip Starter	#118 Hip Roll	#211 Ridge	#211 Closed Ridge End	#118/#211 2 Hip 1 Ridge Terminal*

**BONNET, ARIES AND ROUNDED RIDGE TRIM GROUP**

Bonnet hip rolls are inspired by the cottages and estates of rural England. These pieces nestle into the field of the tiles to give a seamless, more organic finish to the hips. The Aries hip plate provides a sharper edge to the hip roll, typically used with formal shingle tiles. Rounded interlocking ridge tiles are the companion ridge typically used with bonnet hips.

HIP STARTER	HIP		RIDGE
			
Bonnet Hip Starter	Bonnet Hip Roll	Aries Hip Plate	Rounded Interlocking Ridge

**DECORATIVE HIP STARTERS AND RIDGE END CAPS**

				
Lion's Head	Lion's Head Old Style	Dolphin	3 Leaf	5 Leaf
		<p><b>CUSTOM</b> Ludowici can work with you to create custom designs to complete your design vision.</p>		
Flower & Leaf	Shell			

\*Ludowici makes ridge/hip terminals to fit any roof geometry. Contact your Ludowici representative for assistance.



## GRADUATED AND TOWER TILE

Crafting tile to fit curved roofs has been a specialty of Ludowici's since the late 1800s. To accommodate the geometry of a curved roof, Ludowici artfully tapers tile to become progressively smaller from the bottom to the top of a curved roof. These graduated tiles are custom designed to fit a specific roof. This custom process requires Ludowici to send technicians to the jobsite to take detailed field measurements of the physical structure. Ludowici craftsmen use these drawings to design patterns and molds for each row of tiles. Graduated tiles are then pressed from these molds and are finished to match the rest of the roof tiles. Ludowici crafts graduated tiles to match all of its tile profiles as well as decorative finials.

## CHIMNEY POTS AND WALL COPING

Not only can chimney pots enhance the efficiency of your fireplace, but they also add architectural charm and a finished, polished look to your building. Whether you are looking for an ornate Tudor design or the clean lines of a classic chimney pot, Ludowici offers a variety of chimney pot designs and sizes to fit your style. Ludowici also offers rainguards and architectural wall coping to help add the final touch to your design.



These products are offered in the following standard colors:



CP Buff



CP Sandstone



CP Gray Limestone



CP Blue Limestone



CP Terra Cotta



CP Brick Red



CP Salt Glaze











CP Black Glaze

Custom colors are also available for chimney pots. Wall coping is available in standard chimney pot colors, as well as all Ludowici standard and custom color blends.

# ADDITIONAL PROFILES

Ludowici has created hundreds of thousands of roof tile and accessory profiles over the last century. There are many more options from the Legacy Collection available to view online at [Ludowici.com](http://Ludowici.com), including:

ADDITIONAL PROFILES							
STRAIGHT BARREL MISSION	TAPERED BARREL MISSION	CUBANA	ROMAN	GREEK	FLAT SLAB	GREENWICH	MORANDO CLOSED SHINGLE
							
16" & 14 1/4"	14 1/4"	18 3/8"			3/8" & 5/8" Thickness		

## UNDERLAYMENT AND FASTENERS

A Ludowici roof is crafted to last a lifetime and your underlayment and fasteners should be just as durable. Ludowici Pro 70 Underlayment provides superior roof deck coverage versus traditional felt underlayment. It does not curl or scuff and its rubberized asphalt content provides a more pliable membrane, proving itself to be less susceptible to damage during installation and saving on installation time by laying smoother. Ludowici Pro 70 does not decompose like felt, providing a much more stable and long lasting underlayment for your new Ludowici roof.

Ludowici also offers a number of installation accessories such as hurricane clips, Quick-Tach brackets, and stainless steel screws. Please contact your Ludowici representative for more information.





PRIVATE RESIDENCE  
*Orlando, FL*

## OLD WORLD COLLECTION

If you are seeking old-world charm in a terra cotta roof that's modestly priced, you'll love Ludowici's unique Old World Collection. This special collection includes larger dimension barrel tiles and other tile profiles made popular long ago in Europe and Mexico and treated to look centuries old. Manufactured by TERREAL and exclusive partners, these clay tiles come in a range of profiles, colors and sizes and are available through Ludowici.

# LANGUEDOCIENNE



CHARTREUSE DE LA VERNE  
St. Tropez, France

Prominent in the architecture across the Mediterranean and the south of France, the Languedocienne mission barrel system features generously curved terra cotta tiles comprised of tapered mission caps and pans with a smooth surface. The long length tile results in fewer pieces per square, creating one of the most economical roof tile systems on the market. Available in five standard finishes and five special order finishes, Languedocienne is the perfect roof tile for restoration and new construction projects alike. Languedocienne is manufactured in France by TERREAL and is sold exclusively by Ludowici in North America.

CHARACTERISTIC	LANGUEDOCIENNE	PROFILE
Weight Per Square	948 lbs.	
Pieces Per Square	158 pcs.	
Overall Size	19 1/2" x 8" x 6"	
Exposure	11" C.C. x 16 1/2"	
Minimum Slope	4:12	

## STANDARD COLORS



CATHEDRAL



FIRED EARTH



MANOR



OLD PANACHE



OLDISH

## SPECIAL ORDER FINISHES



DARK PANACHE



NATURAL RED



TERRE DE SUD



TOBACCO



VIEUX MIDI

## APPROVALS AND CERTIFICATIONS

- ◆ Miami-Dade NOA: 12-0913.09
- ◆ ASTM C 1167 Grade 1 Roof Tile
- ◆ TDI Evaluation Report RC-469





ROCKEFELLER OBSERVATORY  
New York, NY

# QUARRY TILE FLOORING

Ludowici quarry tile can be found at institutions across the country, including the White House, Ellis Island and Rockefeller Center. This high-traffic commercial-grade flooring is made from the same clay and firing techniques as our roof tiles. Available in standard and custom matte colors\* and smooth or non-skid surfaces, it's suitable for any climate or application and comes with a 75-year material warranty.

CHARACTERISTIC	PROMENADE 6"x9"	PROMENADE 9"x9"	PROMINENCE	VALENCIA
Profile				
Weight Per Square Foot	11.26 lbs.	11.66 lbs.	4.75 lbs.	5.5 lbs.
Pieces Per Square Foot	2.37 pcs. with a 7/16" grout joint	1.62 pcs. with a 7/16" grout joint	3.41 pcs. with a 7/16" grout joint	4.03 pcs. with a 7/16" grout joint
Overall Size	6" x 9" x 3/4"	9" x 9" x 1"	6" x 9" x 1/2"	7" x 7 7/8" x 1/2"

## APPROVALS & CERTIFICATIONS

- ◆ ASTM C-373
- ◆ ASTM C-501
- ◆ ASTM C-648
- ◆ ASTM C-1028-96
- ◆ Water Absorption Less Than 2%

\*Gloss colors are not available for flooring products.

# DIABOLO®



Ludowici is excited to offer a new landscape paver system imported from France designed for tomorrow's urban landscapes, like building plazas and green roofs. The Diabolo system is an architectural idea specially developed by TERREAL and world renowned architect Renzo Piano.

Diabolo is a self-draining outdoor floor covering with a terra cotta and turf finish. The system involves laying down a series of layers of granular materials and fine sand and then placing the terra cotta Diabolos above them using polyamide clips. The terra cotta Diabolos' long format (up to 130 cm) gives you perfectly horizontal lines over large surfaces.

CHARACTERISTIC	DIABOLO®	PROFILE
Dimensions	125 x 5.75 x 10 cm	
Pieces Per Square Meter	11 pcs.	

## AVAILABLE COLORS



RED



RED ORANGE



CHOCOLATE BROWN



VIOLINE



EBONY



For more information about Diabolo, please visit: [ludowici.com/products/floor-tiles](http://ludowici.com/products/floor-tiles)



LIBERTY UNITED METHODIST CHURCH  
*Liberty, MO*

## MODERN USES OF THE MOST TRADITIONAL BUILDING MATERIAL

### TERRA COTTA WALL CLADDING

Through our subsidiary Terreal North America, Ludowici offers a wide variety of highly innovative terra cotta wall cladding products. Beautiful, durable ventilated façades, acoustic claddings and terra cotta panels offer limitless architectural possibilities for projects in any climate.

# SOLAR SHADES

Terra cotta solar shades provide a beautiful way to absorb and diffuse sunlight from building exteriors, creating an effective barrier against summer heat. Ludowici offers TERREAL solar shades that come in a wide range of lengths, cross-sections and colors.

Tap into our engineers for help designing a cladding and/or shade system that meets the specific functional and decorative needs of your project.

*For more information, please visit [terrealna.com](http://terrealna.com) or call 888-582-9052.*





## FACTORY OF IDEAS

Ludowici's Factory of Ideas design center is a unique hands-on facility where visitors work one-on-one with our experts to design their new roof. Housed in a renovated 128-year-old factory building, visitors can browse our entire product line including decorative and historic tiles and trim, select clay tiles for their project, experiment with colors and blends and build mock-ups at the correct pitch and proper orientation for their project.

Visitors can study transitions, explore different trim styles and solve unique construction challenges with Ludowici experts, all with full-size tile and trim pieces. Once approved by the client, the mock-up serves as the template for the project.

And be sure to leave time in your schedule for a tour of our manufacturing facility. See firsthand how we create your tile and visit with Ludowici artisans at work.

### HANDS ON EXPERIENCE

Our unique cart system allows you to take your mock-up outside and view it at the proper pitch and sun exposure.



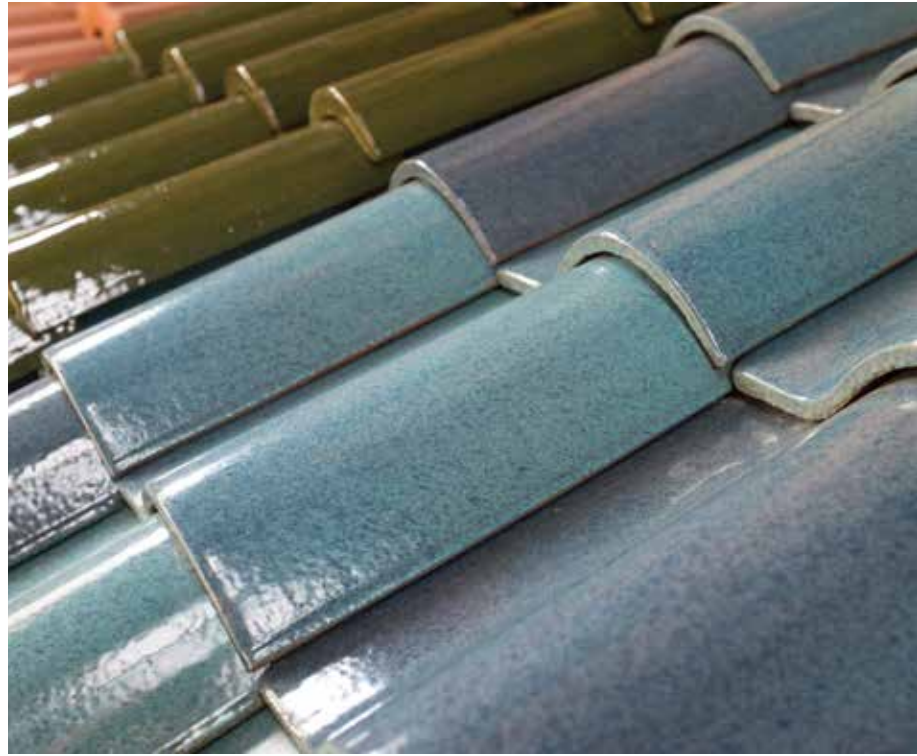



# LUDOWICI®

4757 Tile Plant Road  
P.O. Box 69  
New Lexington, Ohio 43764

800-945-TILE (8453)  
[www.ludowici.com](http://www.ludowici.com)

Ludowici and Terreal North America are your premier source for architectural terra cotta roof tiles, quarry tile flooring, wall cladding and solar shades.

For more information please visit [www.ludowici.com](http://www.ludowici.com) and [www.terrealna.com](http://www.terrealna.com).

Get Social with Ludowici:  
[www.ludowici.com/social](http://www.ludowici.com/social)



# ENERGY EFFICIENCY



## We take saving energy seriously.

Saving energy is important to us. That goes for the energy efficiency of the windows and doors we make and also for our manufacturing processes that produce them.

## The easy way to compare energy efficiency.

If you'd like a quick, accurate way to compare the energy efficiency of windows and doors, just look for the National Fenestration Rating Council (NFRC) information. For details see page 18.

## Energy-saving glass for any climate.

Andersen has the glass you need to get the performance you want, including a variety of Low-E glass options to help you control heating and cooling costs in any climate, including SmartSun™ glass that filters out 95% of harmful UV rays.



## Take comfort in superior weather resistance.

Andersen patio doors feature unique locking systems that pull the door panel snugly tight. The result is an enhanced weather seal, plus improved security.

Our weather-resistant construction seals out drafts, wind and water so well, you can relax in comfort whatever the weather. We carefully select weatherstripping to match each style of window and door to make sure you enjoy superior comfort and reliability.

# DURABILITY

## Tough, time-tested Perma-Shield® exteriors.

The exclusive Andersen® Perma-Shield® system gives our windows and doors a tough, protective shell that safeguards the wood inside. It repels water, resists dents\* and stays beautiful for years.

# RELIABILITY

## OWNER2OWNER® LIMITED WARRANTY

## Quality so solid, the warranty is transferable.\*

Most other window and door warranties end when a home is sold, but our coverage — 20 years on glass, 10 years on non-glass parts — transfers from each owner to the next. And, because it is not prorated, the coverage offers full benefits, year after year, owner after owner. So it can add real value when you decide to sell your home.



## Never needs painting.

The Perma-Shield exteriors on Andersen windows and doors won't peel, blister, flake or corrode,\* so they are virtually maintenance free. They come in seven popular colors: White, Canvas, Sandtone, Terratone, Forest Green, Dark Bronze and Black\*\*.

## Built for years\* to come.

Our products are built strong to last long.† We use the right materials in the right places, including solid wood, fiberglass and our own Fibrex® composite material. These give our windows and doors superior strength, stability and long-term beauty.



## We offer options for the harshest weather environments.

400 Series windows with Stormwatch® protection meet building code requirements in coastal areas.† Products with Stormwatch protection are energy efficient, resist the effects of salt water\* and stand up to hurricane-force winds and wind-borne debris.†† For details visit: [andersenwindows.com/coastal](http://andersenwindows.com/coastal).



\*Visit [andersenwindows.com/warranty](http://andersenwindows.com/warranty) for details. \*\*See your Andersen dealer for availability. †See your local code official for building code requirements in your area. ††AAMA/WDMA/CSA 101/I.S.2/A440-08 PG 70.



# HOW WILL **YOU DESIGN** WITH WINDOWS & DOORS?

Are you matching an existing look? Creating a new look? Seeking architectural authenticity? Through colors, materials, shapes, trim, accessories and more, Andersen gives you the critical tools to achieve your look, style and unique vision.



When designing a new home, you use floor plans, but it's also a good idea to use wall plans.



## REPLACING

When choosing replacement products, look at the materials used to make them. Andersen® replacement windows and doors have rich wood interiors that add value to your home. So you're not just replacing, you're upgrading.



When you have a look and style you want to emulate, you can accomplish it with Andersen through our array of choices.

Window location can make a dramatic difference. Position a large window to celebrate your home's surroundings. Or configure your windows or doors to accentuate the light or warm the room.

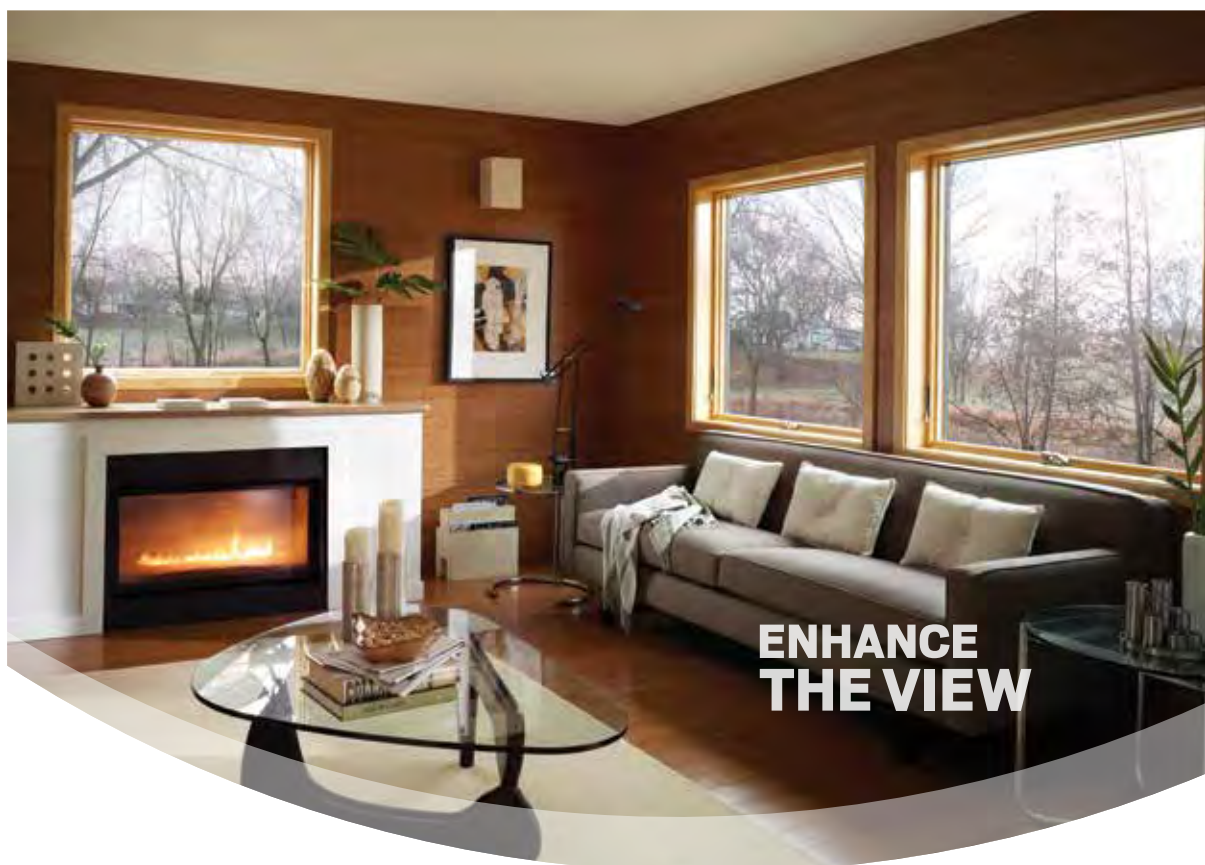

# 1

## SELECT YOUR WINDOW & DOOR TYPES

### WINDOW TYPES

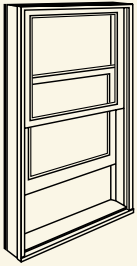

#### DOUBLE-HUNG

A double-hung window has two vertically sliding sash in a single frame. Double-hungs lift open while remaining flush with the wall, making them ideal around patios, decks and walkways.

See page 32.

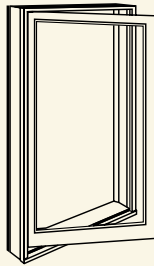

#### CASEMENT

Casement windows are hinged windows that, with a turn of a crank, open outward to the right or to the left. Casements are common above kitchen sinks and give you flexibility to group in stunning combinations.

See page 34.

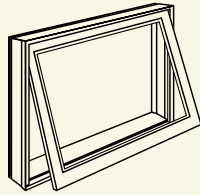

#### AWNING

Awning windows are hinged at the top and open outward. They catch breezes from the left or right and are often used above, below or alongside stationary windows.

See page 34.

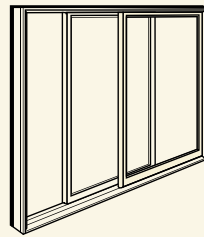

#### GLIDING

Gliding windows feature two sash, with at least one of the sash sliding horizontally past the other. They give you the advantages of double-hung windows with a more contemporary look.

See page 34.

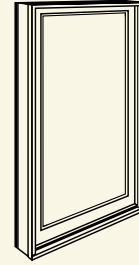

#### STATIONARY

Stationary windows, as the name states, are windows that don't open. Often referred to as picture windows, they're typically used in combination with venting windows.

See page 36.

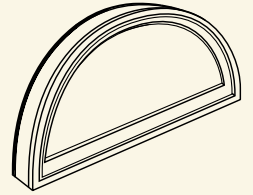

#### SPECIALTY

Specialty windows are stationary windows characterized by their special shapes, including curves and dramatic angles. They can make a signature statement in your home and provide a delicate lighting accent.

See page 36.

**COMBINATIONS** : Explore the many possibilities of putting shapes and sizes together.

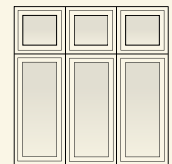
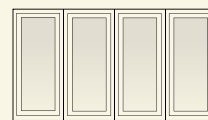
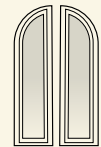
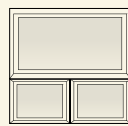
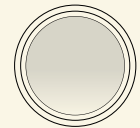
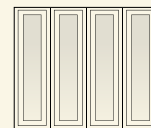
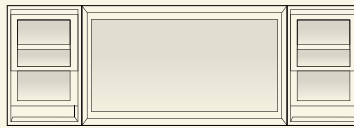
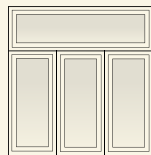
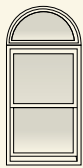

To create your own design go to [andersenwindows.com/windowcentrics](http://andersenwindows.com/windowcentrics).

# 2

## CHOOSE YOUR GLASS

Glass can affect energy efficiency more than any other part of a window or patio door — and not all glass performs the same. Some types of glass do a better job at insulating your home. Others provide greater clarity. You can even choose glass to filter out specific kinds of light. Andersen offers one of the industry's widest arrays of glass options, so you're sure to find the right choice for your climate and your home.

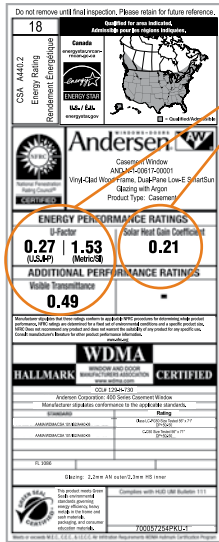

National Fenestration Rating Council (NFRC) Energy Performance Ratings



**U-Factor** indicates how well a product prevents heat from escaping. The lower the number the better.

**Solar Heat Gain Coefficient** measures how well a product blocks heat caused by sunlight. A lower number is typically better.

**Visible Transmittance** refers to how much visible light comes through a product. The higher the number the better.

NFRC ratings for Andersen® products are available at [andersenwindows.com](http://andersenwindows.com).





## REPLACING, REMODELING OR BUILDING

No matter what type of project you're doing, choosing your glass is key. Andersen® high-performance Low-E4® SmartSun™ glass blocks unwanted solar heat while allowing light to stream through. The result is lower energy costs and protection for furniture, carpets and drapes by blocking out 95% of the damaging ultraviolet rays that can cause fading.

### BEST-IN-CLASS GLASS



#### Low-E4® Glass

Outstanding thermal performance for climates where both heating and cooling costs are a concern. It is up to 56% more energy efficient than ordinary dual-pane glass.\*



#### Low-E4 SmartSun™ Glass

It gives you the benefits of Low-E4® glass, plus it helps shield your home from the sun's heat and filters out 95% of harmful UV rays while letting sunlight shine through.



#### Low-E4 Sun Glass

It's tinted for maximum protection from the effects of intense sunlight while providing all the benefits of Low-E4® glass.

Additional glass options including tinted, laminated, tempered and clear dual-pane are available. Contact your Andersen dealer for details.

### Patterned Glass

Patterned glass lets in light while obscuring vision and adds a unique decorative touch to your home.



Cascade



Fern



Obscure



Reed

### PERFORMANCE COMPARISON OF ANDERSEN® GLASS OPTIONS

GLASS	E N E R G Y		L I G H T	
	U-FACTOR	SOLAR HEAT GAIN COEFFICIENT	VISIBLE LIGHT TRANSMITTANCE	UV PROTECTION
<b>SmartSun™</b> Our best overall thermal performance.	★★★★☆	★★★★★	★★★★☆	★★★★★
<b>Low-E4®</b> Outstanding overall thermal performance for climates where both heating and cooling costs are a concern.	★★★★☆	★★★★☆	★★★★☆	★★★★☆
<b>Sun</b> Outstanding thermal performance in southern climates where less solar heat gain is desired.	★★★★☆	★★★★★	★☆☆☆☆	★★★★☆
<b>Dual-Pane</b> Basic thermal performance with high visibility.	★★☆☆☆	☆☆☆☆☆	★★★★★	☆☆☆☆☆

Center of glass performance only. Visit [andersenwindows.com](http://andersenwindows.com) for ENERGY STAR® map and NFRC total unit performance data.

\*Low-E4® glass in summer. Based on comparison of Andersen® 400 Series tilt-wash double-hung window SHGC to the SHGC for clear dual-pane glass non-metal frame default values from the 2006, 2009 and 2012 International Energy Conservation Code "Glazed Fenestration" Default Tables.

# 3

## CHOOSE YOUR EXTERIOR & INTERIOR OPTIONS

### CHOOSE YOUR EXTERIOR WINDOW OR DOOR COLOR

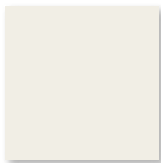

White

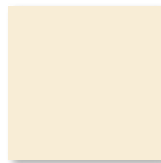

Canvas



Sandtone



Terratone



Forest Green



Dark Bronze



Black\*

### CHOOSE YOUR EXTERIOR TRIM OPTIONS

For more curb appeal, add optional Andersen® exterior trim. It's available in 11 colors, so you can match or complement your window or door colors to create a variety of looks. Made of Fibrex® material, our trim never needs painting, and it won't fade, flake, blister, chalk or peel no matter what the climate! For select shapes, we offer curved trim made of highly durable factory-finished urethane material.



Watch videos and use our visualizer tool to create your own look at:  
[andersenwindows.com/exteriortrim](http://andersenwindows.com/exteriortrim).



Red Rock trim with Sandtone window

#### WINDOW AND DOOR COLORS\*\*

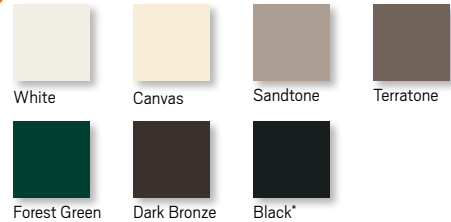

#### TRIM COLORS



### STYLES



**2" Brick Mould**  
Dove Gray trim  
Terratone window



**3 1/2" Flat Casing**  
Dark Bronze trim  
White window



**4 1/2" Flat Casing**  
Canvas trim  
Forest Green window

### HEAD TRIM OPTIONS



**Decorative Drip Cap**



**2" Cornice**



**3 5/8" Cornice**



## REPLACING, REMODELING OR BUILDING

All Andersen® windows and doors are available with a low-maintenance white interior. It not only saves you the time and the trouble of painting, it also creates a smoother, more uniform surface that you just can't achieve with a brush.

## CHOOSE FROM FOUR INTERIOR OPTIONS

The interiors of all Andersen® windows and patio doors are available in unfinished stain-grade pine or with a long-lasting,\* low-maintenance white finish.

Frenchwood® patio doors and Woodwright® windows can also be ordered with unfinished oak or maple interiors. Perma-Shield® patio door interior colors match exterior colors.



Pine



Maple



Oak

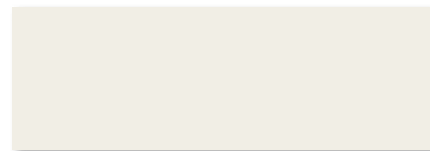

White



# 4

## ADD STYLE WITH GRILLES

Andersen® grilles add character to any home. They are available in a wide selection of standard patterns, semi-custom patterns or custom patterns for a truly signature look.

### GRILLE OPTIONS

MATCH ACROSS ALL PRODUCTS



Colonial Double-Hung



Colonial Picture Window



Colonial Frenchwood® Door

#### Colonial Upper Sash



#### Standard Prairie



#### Semi-Custom

Choose any number of same-size rectangles across or down.



3x1 Upper Sash Only



2x2



3x3

#### Simulated Double-Hung



#### Diamond



#### Custom



#### Custom



#### Your Pattern Here



Our 2 1/4-inch-wide grille can make a casement window look like a double-hung. See page 35.



#### DESIGN YOUR OWN PATTERN

Andersen gives you complete flexibility to design your own custom grille style. You sketch it, our craftsmen will create it.

SHOWN: Andersen 400 Series casements with custom circle pattern grilles in transoms.





## REPLACING OR REMODELING

Grilles influence style, and the choices at Andersen are endless. You can use grilles to make your casement windows look like double-hung windows. Or you can match existing grille patterns. If you want to match existing windows, it's a good idea to take a picture of your current windows before seeing your contractor or Andersen dealer.

## GRILLE CONFIGURATIONS

### Full Divided Light

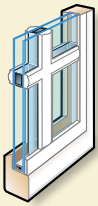

Give your window an authentic look with full divided light grilles that are permanently applied to the interior and exterior of your window with a spacer between the glass.

Permanent Exterior  
Permanent Interior with Spacer



Permanent Exterior  
Permanent Interior

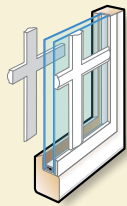

Permanent Exterior  
Removable Interior

### Simulated Divided Light

Simulated divided light offers permanent grilles on the exterior and interior with no spacer between the glass. We also offer permanent exterior grilles with removable interior grilles, available in natural wood or prefinished white.

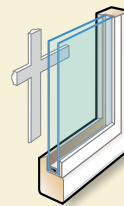

Removable  
Interior Grille



Finelight™ Grilles  
Between-the-Glass

### Convenient Cleaning Options

Removable interior grilles come off for easy cleaning. Andersen® Finelight™ grilles are installed between the glass panes and feature a contoured 1" or 3/4" profile.

### Grille Widths (actual size shown)

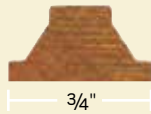

3/4"



7/8"

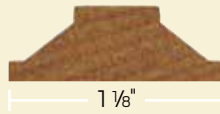

1 1/8"

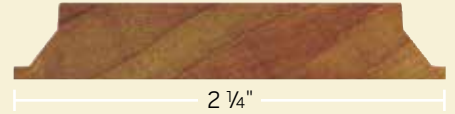

2 1/4"



# WHAT ARE THE DIFFERENT **ANDERSEN**<sup>®</sup> WINDOWS & DOORS?

On the following pages, we present our window and patio door selections according to the different window and door types. Within each type, you'll see our offerings listed by product line. To the right is a quick guide to help you gauge what each product line represents.



**DOUBLE-HUNG**  
Page 32



**CASEMENT / AWNING**  
**GLIDING**  
Page 34



**STATIONARY**  
Page 36

**W I N D O W S**

## ANDERSEN® 400 SERIES WINDOWS & DOORS

The Andersen® 400 Series product line delivers **superior craftsmanship and top performance**. These windows and doors feature the widest range of sizes, styles and accessories.

## ANDERSEN 200 SERIES WINDOWS & DOORS

The 200 Series product line concentrates on the **most popular sizes and options**, delivering on our promise to provide renowned Andersen quality at an uncommon value.

## ANDERSEN COMPLEMENTARY WINDOWS & DOORS

Our complementary windows and doors are **custom-crafted in dramatic sizes and shapes** to accompany our 400 Series products.

## ANDERSEN ENTRY DOORS

Handcrafted from the finest wood available, Andersen entranceways offer **uncommon elegance and exceptional beauty** to enhance the character of your home.



**GLIDING**  
Page 38



**HINGED**  
Page 40



**ENTRY**  
Page 42

**D O O R S**

# DOUBLE-HUNG WINDOWS

Andersen® 400 Series Woodwright® insert replacement windows with pine interiors.



## 400 SERIES WOODWRIGHT® WINDOWS

Make new homes look old and old homes like new.

Woodwright windows are a great choice for traditional architecture. With their thick, sloped sills, precision-milled wood interiors and historically accurate grille patterns, these windows bring authentic old-world character to homes of all ages.



Woodwright full-frame windows offer you the ability to select from a simple rectangular shape or create a distinct, architecturally inspired look with graceful arches.

### REPLACING A WINDOW?

Woodwright insert windows can save you time and money. (See opposite page.)



## 400 SERIES TILT-WASH WINDOWS

Our most popular double-hung window.

Year after year, the Andersen 400 Series tilt-wash window is our best-selling double-hung window — and for good reason. Extremely energy efficient, it gives you a wide array of decorative and performance options.



Andersen® 400 Series tilt-wash full-frame windows are available with impact-resistant glass and structural upgrades to meet the tough building codes of hurricane-prone coastal areas. See your local code official for specific requirements.

### REPLACING A WINDOW?

400 Series tilt-wash insert windows can save you time and money. (See opposite page.)



## 200 SERIES TILT-WASH WINDOWS

Our 200 Series tilt-wash double-hung window comes in our most popular sizes and gives you our most requested options. You still get low-maintenance exteriors and real wood interiors, along with our renowned Owner-2-Owner® limited warranty.\*

## NARROLINE® WINDOW CONVERSION KIT

If your home has Andersen Narroline® windows that were made after 1967, our quick conversion kit can turn them into convenient, tilt-wash double-hung windows with high-performance Low-E4® glass. It installs easily with less mess than ordinary window replacement. Plus, it matches your existing window inside and out and is backed by our full Owner-2-Owner limited warranty.\*



Visit [andersenwindows.com/narroline](http://andersenwindows.com/narroline), where you can download measuring guides and watch an installation video.



## REPLACING

There are many reasons to replace your old windows, and just as many advantages. Whether you want to increase energy efficiency, update the style of your home or simply replace windows that just don't operate like they should, Andersen has replacement solutions that are perfect for the job. Look for them on these two pages, plus pages 34–35.



### Double-hung replacement made easy.

Insert replacement windows are specially designed to save you time and money. They fit into your existing wood window frame without removing interior or exterior trim, so there's less disruption to your home, and its original character is preserved. You simply remove your old window and install the new insert window in the existing opening. Another advantage: You can do it from inside your home — which makes a big difference if you're replacing windows on the second level. All Andersen® insert windows come with screws, shims and flexible foam backer rod to make installation easier.



To see if an Andersen insert window is right for your home, visit [andersenwindows.com/replacement](http://andersenwindows.com/replacement), where you can download a measuring guide and watch an installation video.

### OPENING CONTROL DEVICE KIT

Window opening control devices for 400 Series and 200 Series double-hung windows limit the opening of the lower sash to less than 4 inches when the window is first opened. Release of the device allows the sash to fully open for maximum ventilation, escape or rescue. Once the lower sash is returned to the closed position the device automatically resets. The device is available in White and Stone finishes.



See your local code official for building code requirements in your area. See the \*\* disclaimer on page 35 for additional details.

DOUBLE-HUNG WINDOW FEATURES		400 SERIES WOODWRIGHT®	400 SERIES WOODWRIGHT INSERT	400 SERIES TILT-WASH	400 SERIES TILT-WASH INSERT	200 SERIES TILT-WASH	NARROLINE® CONVERSION KIT
<b>Low-Maintenance Exteriors</b>							
	White	●	●	●	●	●	●
	Canvas	●	●	●	●		
	Sandtone	●	●	●	●	●	●
	Terratone	●	●	●	●		●
	Forest Green	●	●	●	●		
	Dark Bronze	●	●	●	●		
	Black†	●	●	●	●		
<b>Interiors</b>							
	Maple	●	●				
	Oak	●	●				
	Pine	●	●	●	●	●	●
	White	●	●	●	●	●	●
<b>Easy Cleaning</b>							
	Tilt-to-Clean Sash	●	●	●	●	●	●
<b>Grilles</b>							
	Full Divided Light	●	●	●	●		●
	Simulated Divided Light	●	●	●	●	●	●
	Finelight™ (Grilles-Between-the-Glass)	●	●	●	●	●	●
	Removable Interior Grilles	●	●	●	●	●	●
<b>Performance Options</b>							
	Stormwatch® Protection			●			
<b>Glass</b>							
	Low-E4®	●	●	●	●		●
	Low-E4 Sun	●	●	●	●		●
	Low-E4 SmartSun™	●	●	●	●		●
	Low-E					●	
	Low-E Sun						
	Low-E SmartSun					●	
	Dual-Pane					●	
<b>Unit Sizes</b>							
	Minimum Width	1'-9 5/8"	1'-4 1/2"	1'-9 5/8"	1'-9 1/4"	1'-7 1/2"	Fits Narroline® windows made after 1967
	Maximum Width	3'-9 5/8"	3'-9 5/8"	3'-9 5/8"	3'-8 7/8"	3'-3 1/2"	
	Minimum Height	3'-0 7/8"	2'-3 3/4"	3'-0 7/8"	3'-0 3/8"	2'-11 1/2"	
	Maximum Height	6'-4 7/8"	6'-5"	7'-8 7/8"	7'-6 5/8"	5'-11 1/2"	
	<b>Custom Sizes</b> ▲	●	●		●		

†See your Andersen dealer for availability. For complete product details, visit [andersenwindows.com/windows](http://andersenwindows.com/windows). Printing limitations prevent exact color duplication.

# CASEMENT | AWNING | GLIDING WINDOWS



## 400 SERIES CASEMENT WINDOWS

**Made like no other.**

Andersen® 400 Series casement windows start with a design that is extremely energy efficient. Add to that a solid-wood sash covered inside and out by low-maintenance Perma-Shield® cladding to protect against water damage. Then give them rich, natural pine interiors and it's easy to see why they have become our best-selling window.



Conventional 400 Series casement windows are available with upgrades to meet the tough building codes of hurricane-prone areas. See your local code official for specific requirements.

### REPLACING A WINDOW?

**400 Series replacement casement windows** can save you time and money. (See opposite page.)



## 400 SERIES AWNING WINDOWS

**Beautiful...versatile...practical.**

Andersen 400 Series awning windows give you the same features and outstanding performance platform as our casement windows. In addition, they add design options. For example, placed high on a wall, awning windows can bring light and fresh air into your home without compromising privacy.



Conventional 400 Series awning windows are available with upgrades to meet the tough building codes of hurricane-prone areas. See your local code official for specific requirements.

### REPLACING A WINDOW?

**400 Series replacement awning windows** can save you time and money. (See opposite page.)



## 400 SERIES GLIDING WINDOWS

**Designed to be one of the best-engineered windows of its kind.**

In addition to providing top energy efficiency, reliable performance and uncommon beauty, both sash on our 400 Series gliding windows can be opened to the left or right to give you improved ventilation.



## 200 SERIES GLIDING WINDOWS

**Easy operation. Excellent energy efficiency.**

Andersen 200 Series gliding windows feature a single operating sash. These windows are available in our most popular sizes with our most requested options and give you low-maintenance exteriors, real wood interiors and the security of our renowned Owner-2-Owner® limited warranty.\*



## REPLACING OR REMODELING

If you're remodeling or replacing windows, you should know that building codes sometimes require egress windows\* — ones that can be used as an emergency exit. Casement windows are often your best choice for egress, because they provide a larger passageway than double-hung or gliding windows. And here's another Andersen advantage: If the other windows in your home are double-hungs, our 2 ¼-inch-width grille running across the center of a casement window simulates the look of a double-hung. See page 22 for example.



### Casement and awning window replacement made easy.

If you're replacing old casement or awning windows, Andersen makes replacement windows specifically for the job. They come fully prepped for easy installation with the nailing flange removed, holes predrilled, and a convenient installation kit including screws, shims and flexible foam backer rod to help you install like a pro.

### OPENING CONTROL DEVICE KIT\*\*

Window opening control devices for 400 Series casement windows feature a simple, orange push-button clearly identifying the release mechanism of the device, and an innovative flip cap that shields it from accidental release. Made of corrosion-resistant stainless steel, the opening control device can operate with the insect screen in place and automatically reengages when the window closes.

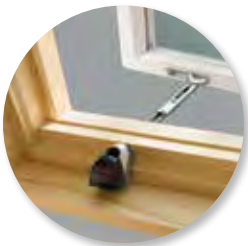

### SINGLE-ACTUATION LOCK

This Andersen® lock is engineered to secure casement windows firmly at multiple points with just one handle. The single-actuation lock also features a “reach-out” action that pulls in the sash for a weathertight seal.



CASEMENT, AWNING & GLIDING WINDOW FEATURES		400 SERIES CASEMENT	400 SERIES REPLACEMENT CASEMENT	400 SERIES AWNING	400 SERIES REPLACEMENT AWNING	400 SERIES GLIDING	200 SERIES GLIDING
<b>Low-Maintenance Exteriors</b>							
	White	●	●	●	●	●	●
	Canvas	●	●	●	●	●	
	Sandtone	●	●	●	●	●	●
	Terratone	●	●	●	●	●	
	Forest Green	●	●	●	●	●	
	Dark Bronze	●	●	●	●	●	
	Black <sup>1</sup>	●	●	●	●	●	
<b>Interiors</b>							
	Pine	●	●	●	●	●	●
	White	●	●	●	●	●	●
<b>Grilles</b>							
	Full Divided Light	●	●	●	●	●	
	Simulated Divided Light	●	●	●	●	●	●
	Finelight™ (Grilles-Between-the-Glass)	●	●	●	●	●	●
	Removable Interior Grilles	●	●	●	●	●	●
<b>Performance Options</b>							
	Stormwatch® Protection	●		●			
<b>Glass</b>							
	Low-E4®	●	●	●	●	●	
	Low-E4 Sun	●	●	●	●	●	
	Low-E4® SmartSun™	●	●	●	●	●	
	Low-E						●
	Low-E Sun						
	Low-E SmartSun						●
	Dual-Pane	●	●	●	●		●
<b>Unit Sizes</b>							
	Minimum Width	1'-5"	1'-5"	2'-0 1/8"	2'-0 1/8"	2'-11 1/4"	2'-11 1/2"
	Maximum Width	7'-0 5/8"	7'-0 5/8"	5'-11 7/8"	5'-11 7/8"	5'-11 1/4"	5'-11 1/2"
	Minimum Height	2'-0 1/8"	2'-0 1/8"	1'-5"	1'-5"	1'-10 1/4"	1'-5 1/2"
	Maximum Height	5'-11 7/8"	5'-11 7/8"	4'-0"	4'-0"	4'-11 1/4"	4'-11 1/2"
	<b>Custom Sizes</b> 	●	●	●	●		

\*See your local code official for specific requirements. \*\*Window opening control devices may provide a potential alternative (compared to a window guard) to meet minimum sill height code requirements contained in the 2006, 2009 and 2012 editions of the International Residential Code (IRC) and International Building Code (IBC). Check with your local code official for local code requirements as well as to determine if the minimum window sill height code has been adopted in your area and if this device is accepted as an alternative to the minimum sill height requirement. <sup>1</sup>See your Andersen dealer for availability. For complete product details, visit [andersenwindows.com/windows](http://andersenwindows.com/windows). Printing limitations prevent exact color duplication.