

7/22/2021

CERTIFICATE OF APPROPRIATENESS

John Olszewski
Bedrock LLC.
630 Woodward Ave.
48226

RE: Application Number #21-7301; 660 Woodward Ave., Detroit Financial Historic District

Dear Mr. Olszewski,

At the regular meeting held 7/14/2021, the Detroit Historic District Commission reviewed the above-referenced application for building permit. Pursuant to Section 5(10) of the Michigan Local Historic District Act, as amended, being MCL 399.205(10), MSA 5-3407(5)(10); Section 25-2-57(b) of the 1984 Detroit City Code; Detroit Historic District Commission Resolution 97-01 (adopted August 13, 1997); Detroit Historic District Commission Resolution 97-02 (adopted October 8, 1997); and Detroit Historic District Commission Resolution 98-01 (adopted February 11, 1998), the staff of the Detroit Historic District Commission has reviewed the above-referenced application for building permit and hereby issues a Certificate of Appropriateness, which is effective as of 7/14/2021:

The following work proposed at the as per the attached drawings, meets the Secretary of the Interior's Standards for Rehabilitation Standards and the Elements of Design for the Detroit Financial Historic District:

- Install a new permanent enclosed awning at the building's north elevation, first story, as per the attached drawings

Please retain this Certificate of Appropriateness for your files. You should now proceed to the City of Detroit Building, Safety, Engineering and Environmental Department. The Detroit Historic District Commission's approval and issuance of a Certificate of Appropriateness does not waive the applicant's responsibility to comply with any other applicable ordinances or statutes. If you have any questions regarding this letter, please contact me at (313) 224-8907.

For the Commission:



Jennifer Ross
Staff, Detroit Historic District Commission



June 21, 2021

City of Detroit
Ms. Jennifer Ross
Historic District Commission
2 Woodward Ave., Suite 800
Detroit, MI 48226

RE: First National Building
660 Woodward Ave, Detroit, MI

Dear Ms. Ross,

Bedrock Detroit, on behalf of 660 Woodward Associates LLC, is writing to the City of Detroit Historic District Commission (HDC) regarding the building located at 660 Woodward Ave, historically known as the First National Building. The building has been undergoing an extensive rehabilitation since 2011, including numerous retail storefront modifications previously approved by HDC. At the February 11, 2015 meeting, a seasonal outdoor seating awning assembly was approved by the HDC, and later approved by City Council. (see attached documentation) The awning assembly was installed at that time, and has been in use by the restaurant tenant since. Due to aging materials and COVID protocol updates, the original structure was removed, and a new structure was proposed in its place. The new structure was given a temporary Notice to Proceed (per COVID protocol) by HDC staff on March 25, 2021, and we are now requesting permanent approval from the HDC.

Physical Characteristics

The proposed awning assembly is similar in character to the original. The structure is composed of a sloped frame roof structure made of thin aluminum struts, sitting atop a 6" structural column and beam frame that is anchored to the sidewalk and independent from the building façade. Like the original awning, there are no structural connections to the façade or physical impact or damage to historic materials. (see attached photos of the façade after removal of the original awning)

The aluminum roof frame is wrapped with a black canvas awning material. The awning roof is sloped its entire length with a 30" tall fascia panel at the front for tenant signage. This is a slight modification from the original awning, which was composed of three awnings tied together. The end awnings had a simple 30" tall square profile fascia with no sloped roof. The middle section continued the 30" tall black fascia panel, but with a sloped roof on top made of beige canvas. Similar to the original, a removable gasket is installed at the top and bottom of the roof structure with flashing along the top to protect from water intrusion.

The sides of the awning assembly are characterized by removable glazing panels attached to the structural columns. The original black steel pipe railing running along the bottom of the awning assembly remains. The glazing panels sit behind the railing. The original glazing panels were characterized by clear panes of glazing with 8" wide fabric "frames" around the perimeter for reinforcement. Those fabric frames attached to the structural columns and roof framing above. There was a 12" tall, continuous solid aluminum panel along the bottom of the assembly. The

>>>



proposed glazing panels are composed of a series of single hung window assemblies attached to a thin aluminum frame that is mounted directly to the structural columns. Each window frame has a 12" solid aluminum panel at the bottom and clear fixed panel above. See attached shop drawings and renderings.

The original awning structure had signage at various locations, including a large "CENTRAL" written across the top of the center sloped roof structure, lighted channel letters mounted to the granite over the south end of the awning, and small lettering at the center of the fascia panel. The proposed awning looks to remove the large roof signage and channel letter signage from the facade. Small "Central Kitchen + Bar" lettering will be placed along the fascia panel in several locations.

New furniture, string lighting, and heaters, similar to the original, shall be installed under the new awning assembly.

Year-round arborvitae in concrete planters will be installed around the exterior of the awning assembly, similar to the original.

>>>



Conclusion

In total, the new awning assembly is similar in appearance to the previously approved structure and does not significantly alter the appearance of the façade. The awning assembly has the same approximate overall dimensions in length, width, and height. The structure itself will continue to be self-supporting and not structurally connected to the building. Removal of the awning will result in no damage to the façade. The predominant color of the fabric will remain the same, and the 30" fascia, which was the dominant visual feature of the awning also remains the same. The glazing panels nominally increase the amount of glazing on the structure. Moreover, by removing the center beige roof structure with large signage, and replacing with a continuous sloped roof, the overall assembly has a more consistent appearance than the original. The lit channel letter signage is also being removed, which simplifies the appearance even more.

The items listed above provide a synopsis of the proposed scope of work for the rehabilitation of the building. Further detail is provided in the attached drawings, renderings, reports, and photos. Please contact me if you have further questions.

Sincerely,

John Olszewski
Vice President of Construction

Bedrock Detroit
(313) 402-9526

JohnOlszewski@bedrockdetroit.com

>>>



Figure #1: Central Kitchen Awning and Enclosure BEFORE REMOVAL. May 2021



Figure #2: Central Kitchen Awning and Enclosure BEFORE REMOVAL. May 2021

First National Building
660 Woodward, Detroit, MI



Figure #3: Central Kitchen Awning and Enclosure BEFORE REMOVAL. May 2021

First National Building
660 Woodward, Detroit, MI



Figure #4: Central Kitchen AFTER REMOVAL. June 2021

First National Building
660 Woodward, Detroit, MI



Figure #5: Central Kitchen AFTER REMOVAL. June 2021



Figure #6: Central Kitchen AFTER REMOVAL. June 2021

First National Building
660 Woodward, Detroit, MI

THIS IS A 3-PAGE FORM - ALL INFORMATION IS REQUIRED FOR PROJECT REVIEW

HISTORIC DISTRICT COMMISSION PROJECT REVIEW REQUEST

City of Detroit - Planning & Development Department
2 Woodward Avenue, Suite 808
Detroit, Michigan 48226

DATE: _____

PROPERTY INFORMATION

ADDRESS(ES): _____ AKA: _____

PARCEL ID: _____ HISTORIC DISTRICT: _____

SCOPE OF WORK: (Check ALL that apply)

<input type="checkbox"/> Windows/ Doors	<input type="checkbox"/> Walls/ Siding	<input type="checkbox"/> Painting	<input type="checkbox"/> Roof/Gutters/ Chimney	<input type="checkbox"/> Porch/Deck/ Balcony	<input type="checkbox"/> Addition
<input type="checkbox"/> Demolition	<input type="checkbox"/> Signage	<input type="checkbox"/> New Building	<input type="checkbox"/> Major Alteration (3+ scope items)	<input type="checkbox"/> Site Improvements (landscape, trees, fences, patios, etc.)	

BRIEF PROJECT DESCRIPTION: _____

APPLICANT IDENTIFICATION

Property Owner/
Homeowner

Contractor

Tenant or
Business Occupant

Architect/Engineer/
Consultant

NAME: _____ COMPANY NAME: _____

ADDRESS: _____ CITY: _____ STATE: _____ ZIP: _____

PHONE: _____ MOBILE: _____ EMAIL: _____

PROJECT REVIEW REQUEST CHECKLIST

Please attach the following documentation to your request:

PLEASE KEEP FILE SIZE OF ENTIRE SUBMISSION UNDER 30MB

Completed Building Permit Application (highlighted portions only)

ePLANS Permit Number (only applicable if you've already applied for permits through ePLANS)

Photographs of ALL sides of existing building or site

Detailed photographs of location of proposed work (photographs to show existing condition(s), design, color, & material)

Description of existing conditions (including materials and design)

Description of project (if replacing any existing material(s), include an explanation as to why replacement--rather than repair--of existing and/or construction of new is required)

Detailed scope of work (formatted as bulleted list)

Brochure/cut sheets for proposed replacement material(s) and/or product(s), as applicable

NOTE:

Based on the scope of work, additional documentation may be required.

See www.detroitmi.gov/hdc for scope-specific requirements.

Upon receipt of this documentation, staff will review and inform you of the next steps toward obtaining your building permit from the Buildings, Safety Engineering and Environmental Department (BSEtED) to perform the work.

SUBMIT COMPLETED REQUESTS TO: **HDC@DETROITMI.GOV**

P2 - BUILDING PERMIT APPLICATION

Date: _____

PROPERTY INFORMATION

Address: _____ Floor: _____ Suite#: _____ Stories: _____

AKA: _____ Lot(s): _____ Subdivision: _____

Parcel ID#(s): _____ Total Acres: _____ Lot Width: _____ Lot Depth: _____

Current Legal Use of Property: _____ Proposed Use: _____

Are there any existing buildings or structures on this parcel? Yes No

PROJECT INFORMATION

Permit Type: New Alteration Addition Demolition Correct Violations

Foundation Only Change of Use Temporary Use Other: _____

Revision to Original Permit #: _____ (Original permit has been issued and is active)

Description of Work (Describe in detail proposed work and use of property, attach work list)

MBC use change No MBC use change

Included Improvements (Check all applicable; these trade areas require separate permit applications)

HVAC/Mechanical Electrical Plumbing Fire Sprinkler System Fire Alarm

Structure Type

New Building Existing Structure Tenant Space Garage/Accessory Building

Other: _____ Size of Structure to be Demolished (LxWxH) _____ cubic ft.

Construction involves changes to the floor plan? Yes No

(e.g. interior demolition or construction to new walls)

Use Group: _____ Type of Construction (per current MI Bldg Code Table 601) _____

Estimated Cost of Construction \$ _____ By Contractor \$ _____ By Department

Structure Use

Residential-Number of Units: _____ Office-Gross Floor Area _____ Industrial-Gross Floor Area _____

Commercial-Gross Floor Area: _____ Institutional-Gross Floor Area _____ Other-Gross Floor Area _____

Proposed No. of Employees: _____ List materials to be stored in the building: _____

PLOT PLAN SHALL BE submitted on separate sheets and shall show all easements and measurements (must be correct and in detail). SHOW ALL streets abutting lot, indicate front of lot, show all buildings, existing and proposed distances to lot lines. (Building Permit Application Continues on Next Page)

For Building Department Use Only

Intake By: _____ Date: _____ Fees Due: _____ DngBld? No

Permit Description: _____

Permit #: _____ Current Legal Land Use: _____ Proposed Use: _____

Permit#: _____ Date Permit Issued: _____ Permit Cost: \$ _____

Zoning District: _____ Zoning Grant(s): _____

Lots Combined? Yes No (attach zoning clearance)

Revised Cost (revised permit applications only) Old \$ _____ New \$ _____

Structural: _____ Date: _____ Notes: _____

Zoning: _____ Date: _____ Notes: _____

Other: _____ Date: _____ Notes: _____



IDENTIFICATION (All Fields Required)

Property Owner/Homeowner

Property Owner/Homeowner is Permit Applicant

Name: John Olszewski Company Name: 660 Woodward Associates LLC

Address: 630 Woodward Ave City: Detroit State: MI Zip: 48226

Phone: 888-300-9833 Mobile: 313-402-9526

Driver's License #: _____ Email: JohnOlszewski@bedrockdetroit.com

Contractor

Contractor is Permit Applicant

Representative Name: Scott Richardson Company Name: Advanced Building Group

Address: 20260 Sherwood City: Detroit State: MI Zip: 48234

Phone: 313.974.6153 Mobile: 313.400.6884 Email: SRichardson@advancedbg.com

City of Detroit License #: _____

TENANT OR BUSINESS OCCUPANT

Tenant is Permit Applicant

Name: Central Kitchen + Bar Phone: _____ Email: _____

ARCHITECT/ENGINEER/CONSULTANT

Architect/Engineer/Consultant is Permit Applicant

Name: Marygrove Awnings State Registration#: _____ Expiration Date: _____

Address: 12700 Merriman Rd City: Livonia State: MI Zip: 48150

Phone: (734) 250-9069 Mobile: _____ Email: _____

HOMEOWNER AFFIDAVIT (Only required for residential permits obtained by homeowner.)

I hereby certify that I am the legal owner and occupant of the subject property and the work described on this permit application shall be completed by me. I am familiar with the applicable codes and requirements of the City of Detroit and take full responsibility for all code compliance, fees and inspections related to the installation/work herein described. I shall neither hire nor sub-contract to any other person, firm or corporation any portion of the work covered by this building permit.

Print Name: _____ Signature: _____ Date: _____
(Homeowner)

Subscribed and sworn to before me this _____ day of _____ 20____ A.D. _____ County, Michigan

Signature: _____ My Commission Expires: _____
(Notary Public)

PERMIT APPLICANT SIGNATURE

I hereby certify that the information on this application is true and correct. I have reviewed all deed restrictions that may apply to this construction and am aware of my responsibility thereunder. I certify that the proposed work is authorized by the owner of the record and I have been authorized to make this application as the property owner(s) authorized agent. Further I agree to conform to all applicable laws and ordinances of jurisdiction. **I am aware that a permit will expire when no inspections are requested and conducted within 180 days of the date of issuance or the date of the previous inspection and that expired permits cannot be**

Print Name: John Olzsewski Signature: [Signature] Date: 06-21-21
(Permit Applicant) DocuSigned by: D4470126C598437

Driver's License #: 610 45-2468798 Expiration: _____

Subscribed and sworn to before me this 18th day of June 2021 A.D. Wayne County, Michigan

Signature: [Signature] My Commission Expires: April 12, 2025
(Notary Public)

Section 23a of the state construction code act of 1972, 1972PA230, MCL 125.1523A, prohibits a person from conspiring to circumvent the licensing requirements of this state relating to persons who are to perform work on a residential building or a residential structure. Visitors of Section 23a are subject to civil fines.

This application can also be completed online. Visit detroitmi.gov/bseed/elaps for more information.



TRACY O'KEEFE
NOTARY PUBLIC, STATE OF MI
COUNTY OF WAYNE
MY COMMISSION EXPIRES Apr 12, 2025
ACTING IN COUNTY OF Wayne

HISTORIC DISTRICT COMMISSION REVIEW & PERMIT PROCESS

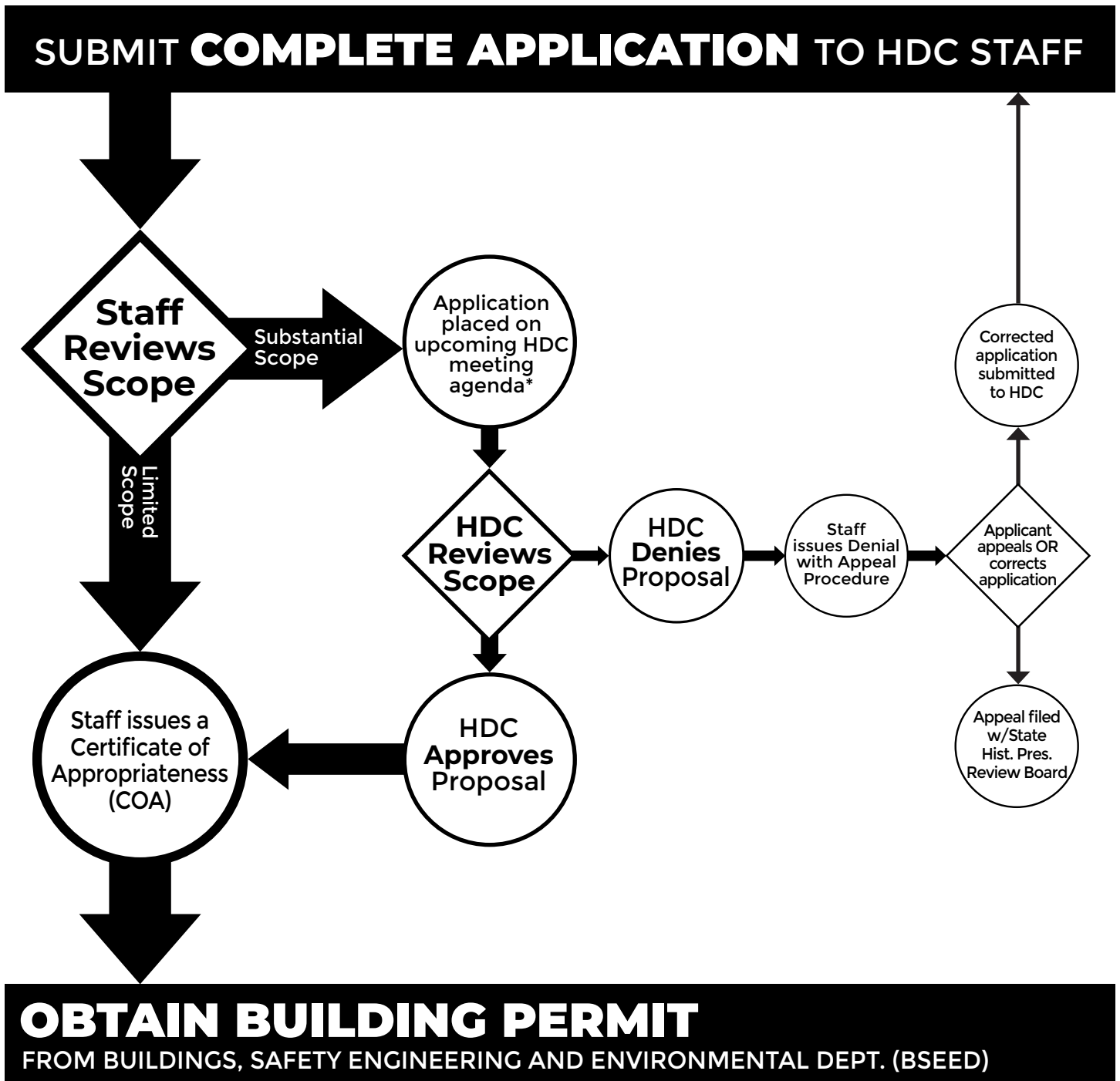

* THE COMMISSION MEETS REGULARY AT LEAST ONCE PER MONTH, TYPICALLY ON THE SECOND WEDNESDAY OF THE MONTH.
(SEE WEBSITE FOR MEETING SCHEDULE/AGENDAS)

FIND OUT MORE AT: www.detroitmi.gov/hdc



City of Detroit
Buildings, Safety Engineering and Environmental Department
Building Division
Coleman A. Young Municipal Center
2 Woodward Avenue, 4th Floor, Suite 408, Detroit, Michigan 48226
(313) 224-3202

BUILDING PERMIT

SITE ADDRESS:	660 WOODWARD		PERMIT NO.: BLD2021-00546
PARCEL NUMBER:	01004105.	SECTOR:	APPLIED: 02/10/2021
TYPE OF WORK:	Alteration		ISSUED: 03/25/2021
ESTIMATED COST :	\$54,987.00		EXPIRES: 09/21/2021
USE:	Restaurant		PMR No.: PMR2021-00579
PERMIT DESCRIPTION:	Per HDC Cert#21-7150, erect free standing accessory Enclosure & Awning over outdoor seating area per plans. Separate Sign, DPW Right-of-Way Permits req. Subject to Field Approval, HDC Certificate Conditions, and all Applicable Federal, State, and Local Executive Orders.		

ZONING DISTRICT: B5-Major Business	USE GRP:	FL AREA:
BLDG TYPE CODE:	STORIES: 1	GROUND AREA:
BETWEEN: Between	and	SIZE: 45578.00
LOT NO.: SUBDIVISION: 01004105.		

<u>Owner</u>	<u>Applicant</u>	<u>Contractor</u>
660 WOODWARD ASSOCIATES LLC 1092 WOODWARD AVENUE DETROIT, MI 48226	American Roll Shutter and Awning 12700 Merriman Rd Livonia, MI 48150	

Fees			
Type	Status	Date	Amount
Building Permit Fee Balance (70%)	INVOICED	02/15/2021	\$847.00
Building Permit Deposit	INVOICED	02/15/2021	\$363.00
Total:			\$1,210.00

Please be advised per the **2015** Michigan Building Code: Each permit issued by the code official under the provisions of the code shall expire by limitation and become null and void if the work authorized by the permit has not begun within 180 days from the issued date of the permit or if not inspected, after the work has begun for a period of 180 days. Before the work may be restarted, the permit shall be reinstated if the code has not changed. If the code has changed and the work was not started, a new permit is required based on the current requirements.

March 25, 2021

NOTICE TO PROCEED
FOR TEMPORARY WORK IN RESPONSE TO COVID-19

James Witherspoon /
Bedrock LLC.
630 Woodward Ave.
48226

RE: Application Number #21-7150; 660 Woodward Ave., Detroit Financial Historic District

Dear James,

The staff of the Detroit Historic District Commission has reviewed the above-referenced application for temporary work in response to the COVID-19 emergency, pursuant to Section 5(10) of the Michigan Local Historic District Act, as amended, being MCL 399.205(10), MSA 5-3407(5)(10); Sections. 21-2-57 and 21-2-73 of the 2019 Detroit City Code and Detroit Historic District Commission Resolution 20-02 (adopted June 10, 2020) and Resolution 20-06 (adopted October 14, 2020), and finds the following work to be inappropriate per the defined Elements of Design for the West Village Historic District and the Secretary of the Interior's Standards for Rehabilitation (36 CFR Part 67):

PROJECT SCOPE:

- **Central Kitchen: Removal and replacement of existing awning / covered patio structure and replace with new awning / covered patio structure, as proposed, in the same foot print as existing.**

However, pursuant to Detroit Historic District Commission Resolutions 20-02 and 20-06, the Detroit Historic District Commission has authorized the above-referenced temporary work to proceed via the issuance of a Notice to Proceed (NTP) because the following condition prevails:

Retaining the resource is not in the interest of the majority of the community.

Please retain this document for your files. This NTP is issued only for temporary work installed and removed prior to June 30, 2021, or as otherwise extended by the Commission in response to the ongoing COVID-19 emergency. Environments altered via benefit of this NTP shall be restored to an appropriate historic condition no later than 180 days after the final expiration of Resolution 20-02, absent the issuance of a Certificate of Appropriateness or NTP for permanent work or other extension by the Commission. The Detroit Historic District Commission's approval does not waive the applicant's responsibility to comply with any other applicable ordinances or statutes.

For the Commission:



Brendan Cagney
Staff
Detroit Historic District Commission

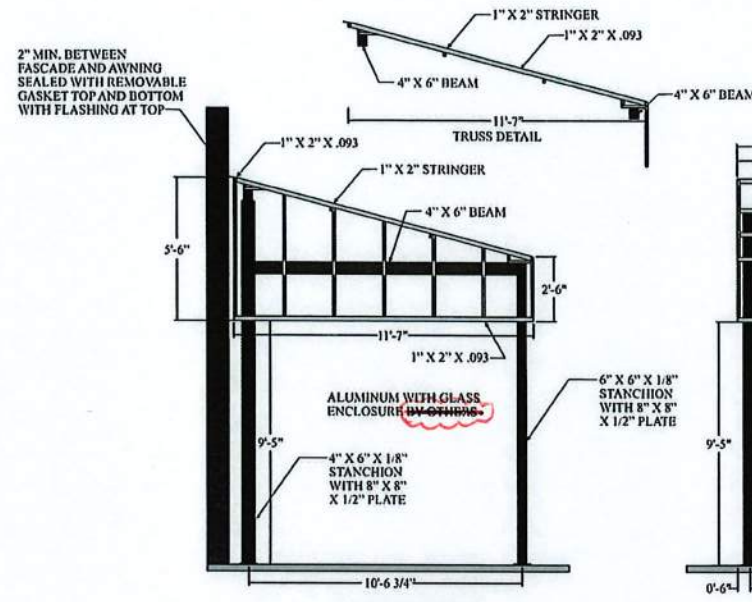

SIDE ELEVATION DIMENSIONS V.I.F.

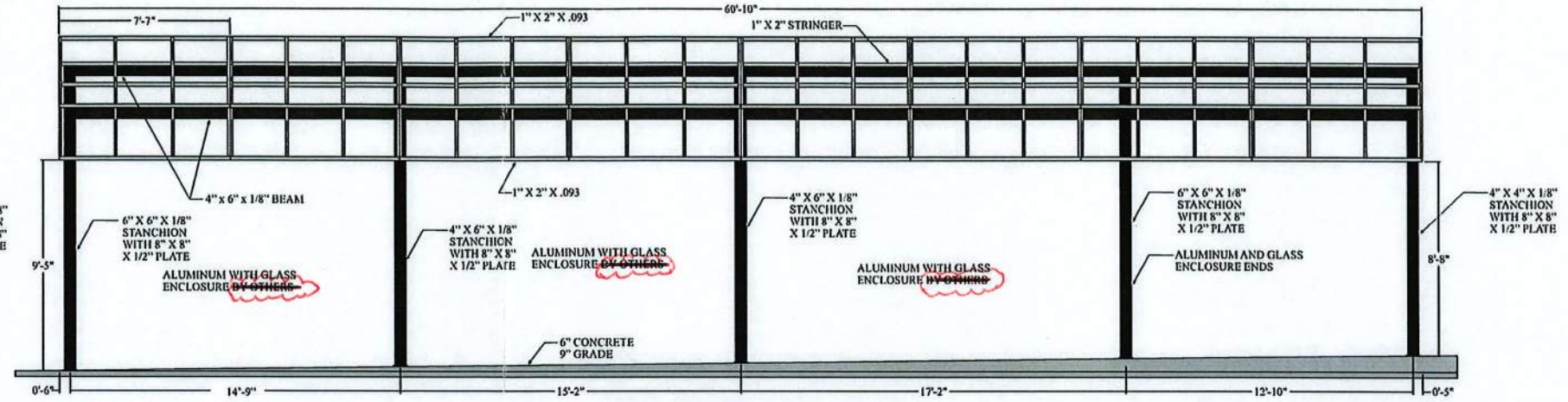

FRONT ELEVATION DIMENSIONS V.I.F.

AWNING IS FREE STANDING

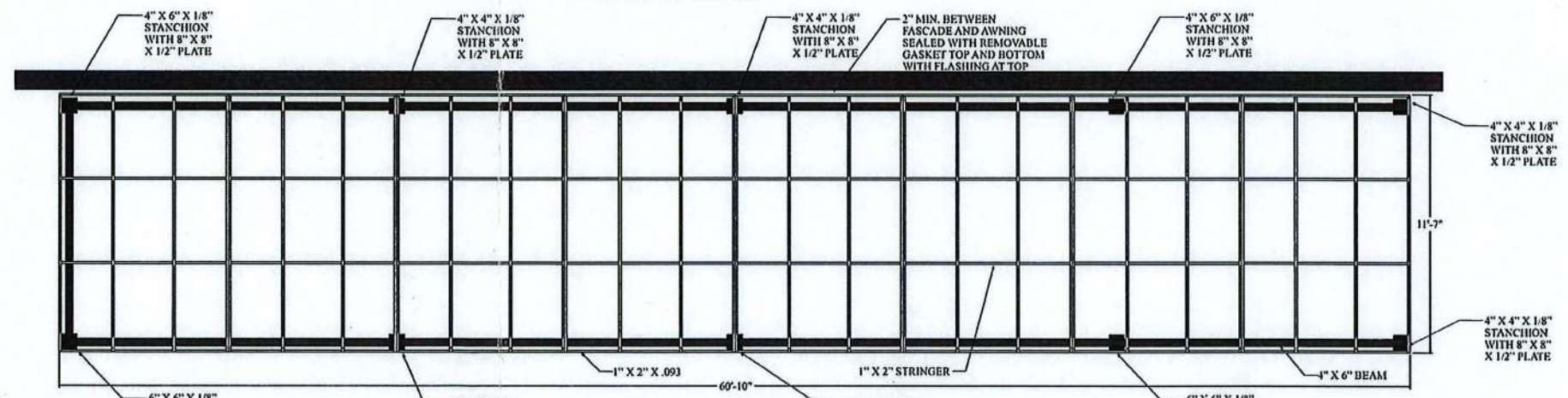
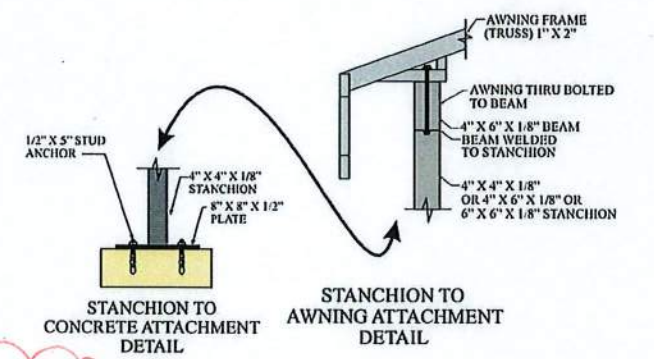

PLAN VIEW DIMENSIONS V.I.F.

AWNING IS FREE STANDING DIMENSIONS V.I.F.

Rev: 02/24/2021
 ENTIRE SCOPE OF
 AWNING + ENCLOSURE
 BY MARYGROVE
 BLD 2021-00546



NOTES:
 ALL FRAMING ALUMINUM
 1\"/>



* TEMPORARY STRUCTURE DUE TO COVID-19 *

DETAIL 1.10: STOREFRONT SYSTEM CONCEPT BY OTHERS

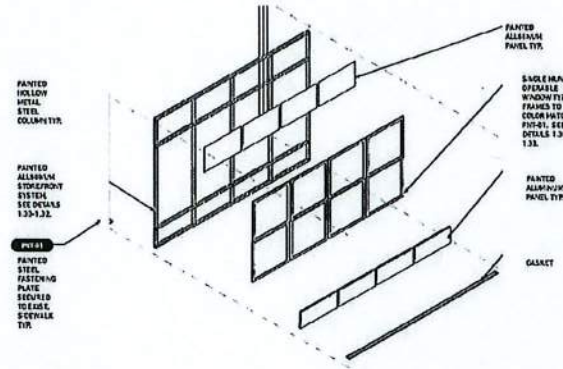

DIMENSIONS V.I.F.

DETAIL 1.20: STOREFRONT SYSTEM CONCEPT PLAN DETAIL BY OTHERS

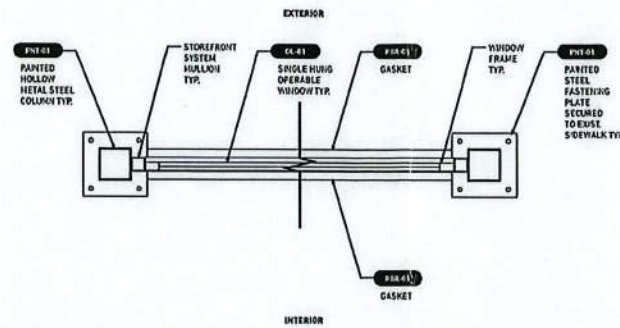

DIMENSIONS V.I.F.

DETAIL 1.30: STOREFRONT SYSTEM A BY OTHERS

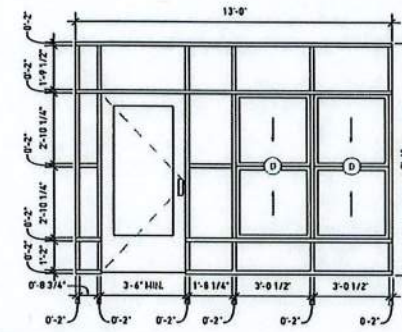

V.I.F. CENTER / ALIGN THE ENCLOSURE DOOR WITH THE EXISTING DOOR AT FND
 DOOR GLAZING TO BE CLEAR TEMP.
 DIMENSIONS V.I.F.

DETAIL 1.31: STOREFRONT SYSTEM B BY OTHERS

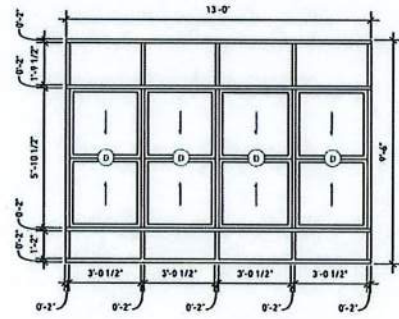

DIMENSIONS V.I.F.

DETAIL 1.32: STOREFRONT SYSTEM C BY OTHERS

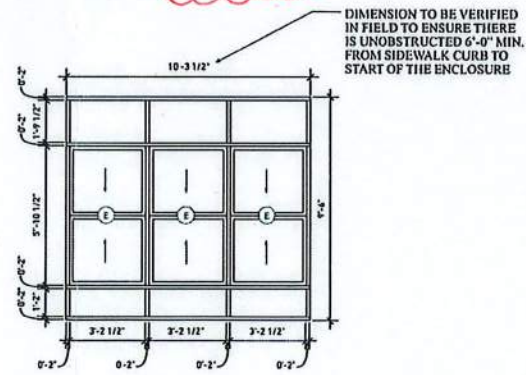

DIMENSIONS V.I.F.

DETAIL 1.33: WINDOW TYPES BY OTHERS

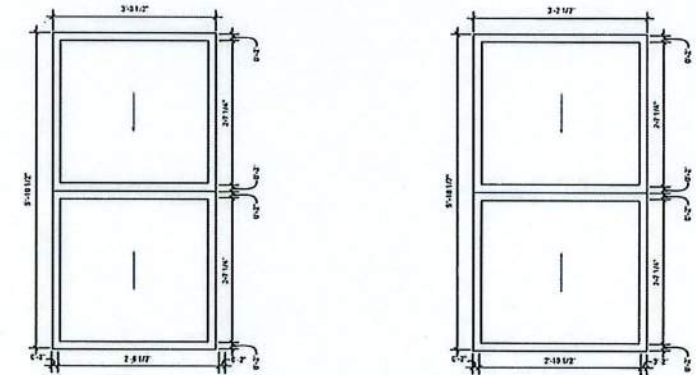

DIMENSIONS V.I.F.

Rev: 02/24/2021
 ENTIRE SCOPE OF
 AWNING + ENCLOSURE
 BY MARYGROVE

Marygrove AWNINGS
 DALE BACIE
 CENTRAL KITCHEN
 660 WOODWARD AVENUE
 DETROIT, MI 48216
 313.921

NOTES:
 ALL FRAMING ALUMINUM
 1" X 1" X .093 UNLESS NOTED
 FRAMES & SUBSTRUCTURE: BLACK
 FABRIC: NATURA BLACK NT7745



BLD 2021-00546

TEMPORARY STRUCTURE DUE TO COVID-19

RENDERING

CENTRAL KITCHEN + BAR
TEMPORARY STRUCTURE DUE TO COVID-19

BLD2021-00546



CENTRAL KITCHEN + BAR
NOVEMBER 2020 // BEDROCK

RENDERING

CENTRAL KITCHEN + BAR

TEMPORARY STRUCTURE DUE TO COVID-19

BLD2021-00546



CENTRAL KITCHEN + BAR
NOVEMBER 2020 // BEDROCK





CENTRAL KITCHEN + BAR

OUTDOOR SEATING PROPOSAL

PROJECT DESCRIPTION

CENTRAL KITCHEN + BAR

The proposed Central Kitchen and Bar Patio Awning is intended to replace the existing awning that is old and outdated. This patio space provides expanded dining options for Central Kitchen patrons and has become even more critical given current capacity restrictions caused by COVID-19.

While the intent with the design of the new Awning is a one-for-one replacement, some improvements are being recommended. The proposed awning will have one continuous roof profile in order to simplify and enhance the appearance from the street. The walls of the patio enclosure will be constructed of more durable materials and feature removable glazed panels rather than rolled plastic sheeting.

The new proposed Awning is a free-standing structure and does not connect to, alter, or impact the building's historic façade or storefront. Simple in material and profile, and constructed of timeless and quality material, this structure is designed to positively impact of the historical character of the building and contribute to the overall streetscape character of the neighborhood.



EXISTING CONDITIONS VS PROPOSED

CENTRAL KITCHEN + BAR



EXISTING CONDITIONS



RENDERING OF PROPOSED

EXISTING CONDITIONS VS PROPOSED

CENTRAL KITCHEN + BAR



EXISTING CONDITIONS



RENDERING OF PROPOSED

EXISTING CONDITIONS VS PROPOSED

CENTRAL KITCHEN + BAR



EXISTING CONDITIONS



RENDERING OF PROPOSED

EXISTING CONDITIONS VS PROPOSED

CENTRAL KITCHEN + BAR



EXISTING CONDITIONS

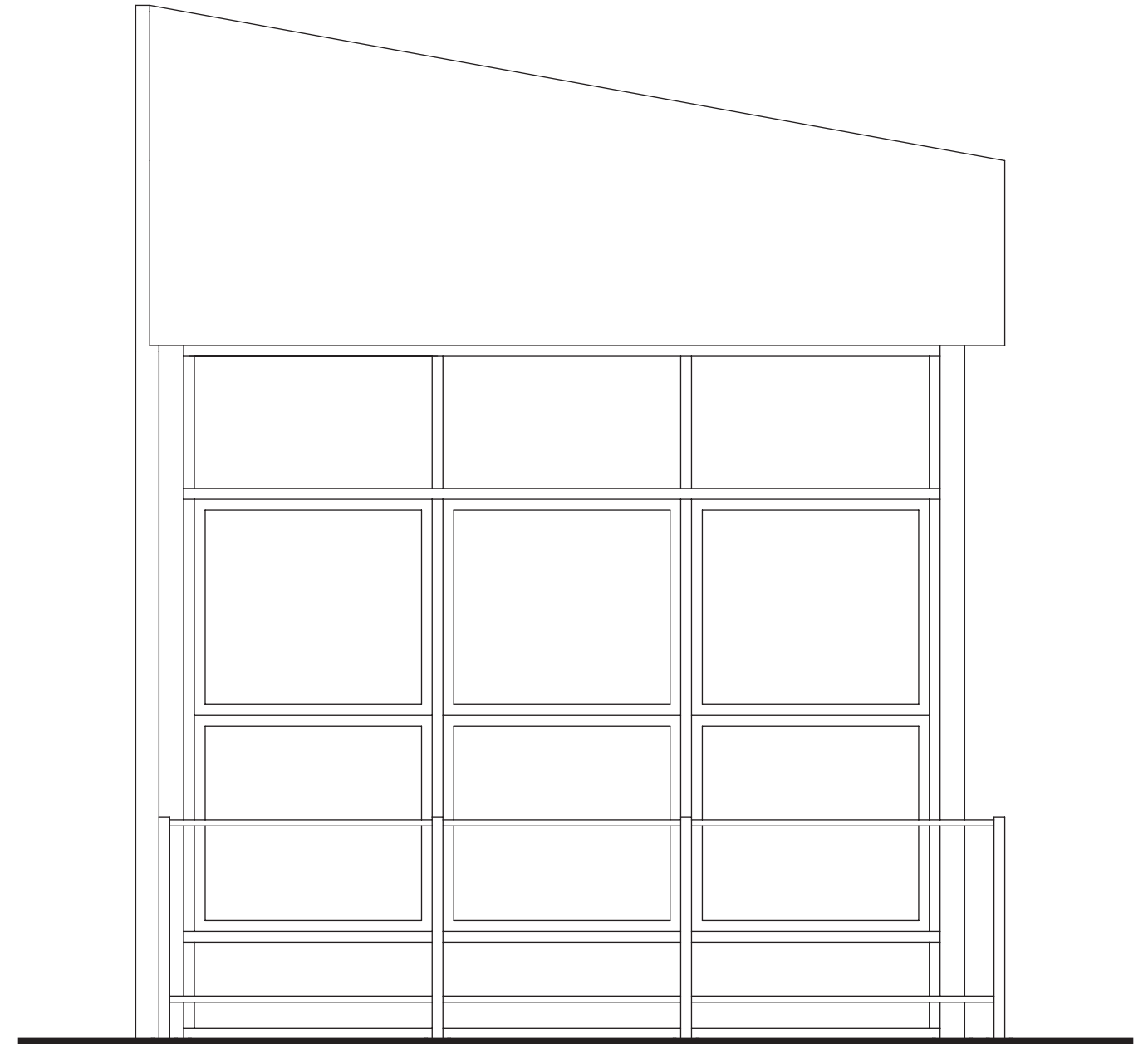

DRAWING OF PROPOSED

ELEVATION VIEW

60'-10"

2'-6"

CENTRAL
KITCHEN + B A R

CENTRAL
KITCHEN + B A R

CENTRAL
KITCHEN + B A R

CENTRAL
KITCHEN + B A R

GRAPHICS ARE 3'-6" WIDE
BY 1'-0" HIGH WITH A TOTAL
OF 3.5' SQFT (x4 = 14'SQFT)



Powered by Innovation ♦ Proven by Performance

Herculite Natura®

TYPICAL PROPERTIES REPORT

PROPERTY	TEST METHOD	TYPICAL TEST RESULTS	
PHYSICAL PROPERTIES		English	Metric
English	Metric		
Weight, oz. per sq. yd.	g/m ²	ASTM D3776 Method C	18 oz. +/- 10% 610 g +/- 10%
Adhesion. (lbs./2 in.)	N/50 mm	ASTM D751 (Free Peel)	Cannot Separate
Breaking Strength (lbs./in.)	N/25 mm	ASTM D5034	W 250 F 185 W 1112 F 823
Tear Strength (lbs.)	N	ASTM D2261/1	W 80 F 55 W 356 F 245
Hydrostatic Burst (PSI)	kPa	ASTM D751	370 2551
Waterproof			Yes
Flame Resistance	ASTM 6413		Pass Meets Calif. State Fire Marshal

Width: 60 inches
Roll Size: 50 Yards

The information contained in this report is believed to be reliable. It is offered in good faith and intended for use as a general guide. Herculite makes no guarantee of results and assumes no obligation or liability whatsoever in connection with the possible use of this information. This report, including any statements concerning the possible use of our products, is not a license to operate under, or intended to suggest infringement of any existing patents.

HERCULITE PRODUCTS, INC.
P.O. Box 435, Emigsville, PA 17318
(800) 772-0036 (717) 764-1192
FAX: (717) 764-5211
www.herculite.com customercare@herculite.com



HERCULITE®

Powered by Innovation • Proven by Performance

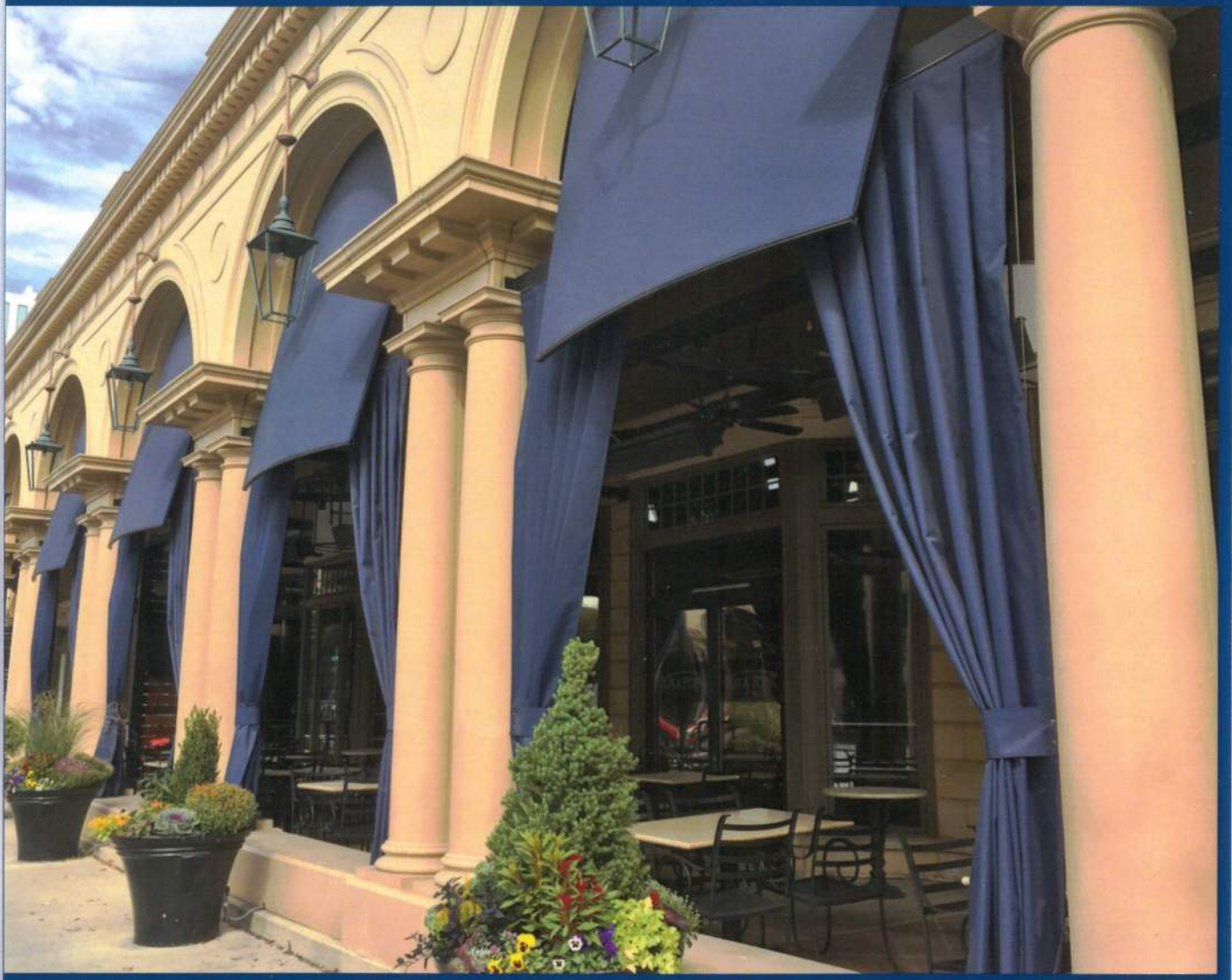

High Performance Awning Fabric

HERCULITE
NATURA®

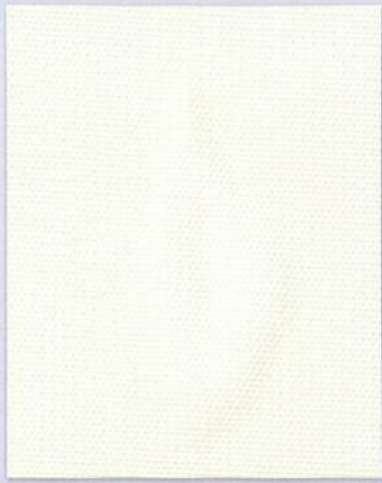

Antique White NT7739

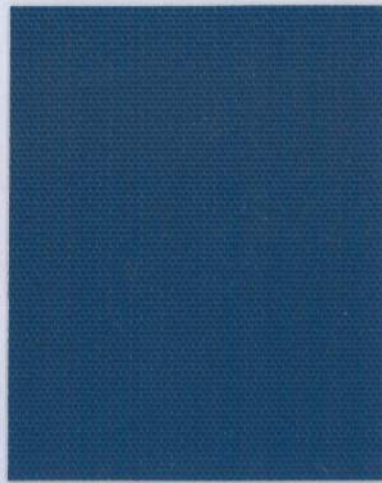

Midnight Blue NT7712



Burlywood NT7738

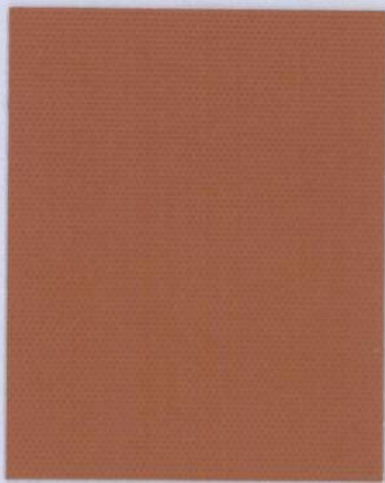

Barrel Tile NT7709

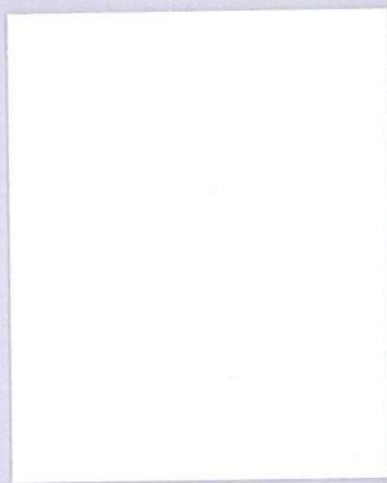

Digital White NT7788



Evergreen NT7711

HERCULITE
NATURA®

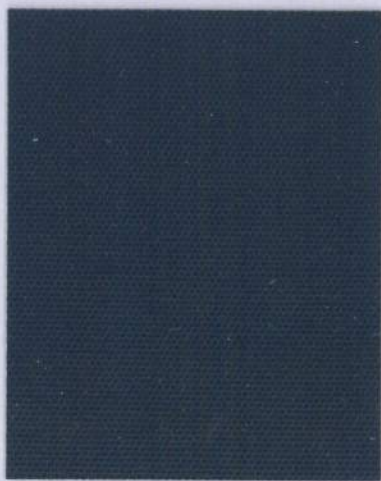

Navy Blue NT7747



Harbor Green NT7701

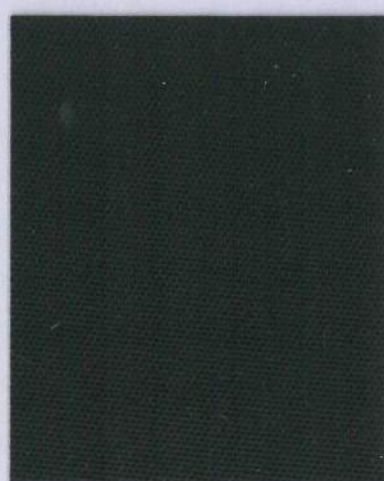

Black NT7745

Natura Awning Fabric features the look and feel of woven cloth on both sides, is completely waterproof, weather-tight and highly fire resistant. This high performance textile is perfect for commercial awnings and canopies designed to protect people and furnishings from the sun's harsh UV rays while providing a natural fabric design element.

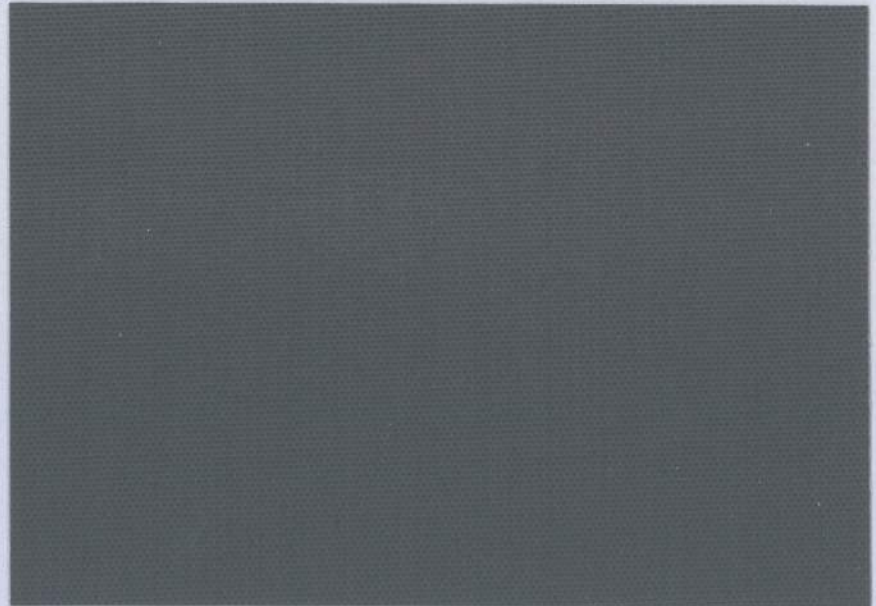

Charcoal Grey NT7718

* This fabric has a distinct face and reverse side that must be considered during fabrication. The underside or "reverse" is indicated by a small **N** within 1/2" of selvage edge.

- Fire Resistant
- Water Proof
- SPF 50+
- Can be sewn or welded using radio frequency, heat, solvent, hot air or wedge welding methods
- Stain & Mildew Resistant
- Dimensionally Stable
- Digitally Printable
- 8 Year Warranty
- Made in the USA



Typical Performance Properties (Average)

Width	60"
Roll Size	50 yd.
Weight	18 oz./sq yd.
Break Strength (lbs./in.)	W 250 F 185
Tear Strength (lbs.)	W 80 F 55
Hydrostatic Burst	370 PSI
Waterproof	Yes
Flame Retardant	CSFM Title 19, NFPA 701 ASTM E84 Class A

This information is offered for your general guidance and has been obtained by modern test methods. It is true and accurate to the best of our knowledge at the time of printing.

Natura® integrates into one product, a fabric-like technical textile with a natural fabric design element. Flame resistance, long term weathering, complete waterproofness, mildew/fungal resistance, self-cleaning, dimensionally stability and durability are achieved through a proprietary thermoplastic polymer formulation. This fabric can be sewn or welded and frame mounted over appropriate awning structures.



 **HERCULITE®**

Powered by Innovation ♦ Proven by Performance

P.O. Box 435, EMIGSVILLE, PA 17318 USA
 (800) 772-0036 (717) 764-1192 FAX (717) 764-5211
 WWW.HERCULITE.COM



Distributed by:

TRIVANTAGE

ORDER. DONE. GOOD CALL.



California		Missouri	(800) 786-7603
Howard	(800) 786-7607	New Jersey	(800) 786-7602
City of Industry	(800) 841-0555	No. Carolina	(877) 540-6803
Colorado	(800) 786-7609	Ohio	(800) 786-7601
Florida	(800) 786-7605	Texas	(800) 786-7610
Georgia	(800) 786-7606	Washington	(800) 213-1465
Illinois	(800) 786-7608		



BEDROCK

— DETROIT —



June 9, 2015

Detroit City Council
1340 Coleman A. Young Municipal Center
Detroit, Michigan 48226

RE: Petition No. 705 – Central Kitchen and Bar for Outdoor Café Permit at 660 Woodward

Honorable City Council:

The above named petitioner has requested permission for Outdoor Café Service. This service will convene every April 1st through November 30th, for a period of three (3) years, from the date of your Honorable Body's approval.

The Department of Public Works/City Engineering Division (DPW/CED) who has jurisdiction over temporary encroachment on City right-of-ways has approved this request contingent upon the petitioners compliance with applicable City ordinance related to outdoor café activities and the remittance of the annual use-permit fee to the Permit Section of the DPW/CED.

The Institute for Population Health (IPH) has approved this petition, subject to petitioner's strict adherence to the 1999 Food Code, Food Law of 2000 and City Ordinance, Chapter 21. No outdoor grilling is permitted without approval from The Institute of Population Health Food Safety Division.

This petition is subject to the approval of The Institute for Population Health (IPH) and is also subject to the petitioner's strict adherence to the 1999 Food Code, Food Law of 2000 and City Ordinance, Chapter 21. No outdoor grilling is permitted without approval from The Institute of Population Health Food Safety Division.

The Historic District Commission has issued the Certificate of Appropriateness for this location as of February 11, 2015.

The Planning and Development Department (P&DD) is not aware of any objections from any other City Agencies involved. It is the recommendation of the P&DD that the petitioner's request be granted subject to the terms and conditions provided in the attached Resolution and that this service will convene every April 1st through November 30th for a period of three years (3) from the date of your Honorable Body's approval.

Respectfully submitted,

John Saad, P.E.
Engineering Services Coordinator
Planning & Development Department

JS:PA:cdc

cc: Aliyah Sabree, Mayor's Office
A. Jemison, HRD
M. Cox, PDD
R. Brundidge, DPW
R. Doherty, DPW/CED
P. Aleobua, P&DD



st

00

000





February 16, 2015

CERTIFICATE OF APPROPRIATENESS

Roman and Roman
275 E. Frank Street
Birmingham, MI 48009

RE: Application Number 15-06: 660 Woodward; Detroit Financial Historic District

Dear Roman and Roman:

At the regular scheduled meeting that was held on February 11, 2015, the Detroit Historic District Commission reviewed the above-referenced application for building permit and hereby issues a Certificate of Appropriateness (COA), which is effective as of February 11, 2015.

A COA has been issued for the following work because it meets the "Secretary of the Interior's Standards for Rehabilitation and Guidelines for Rehabilitating Historic Building's standards 9) *New additions, exterior alterations, or related new construction shall not destroy historic materials that characterize the property. The new work shall be differentiated from the old and shall be compatible with the massing, size, scale, and architectural features to protect the historic integrity of the property and its environment.*

Reconfigure existing fenestration (windows) at the 9 easternmost bays:

- Remove existing 9-light fixed steel windows
- Install new aluminum windows in 5 bays, each of which consists of an operable 6-light floataway window panel (on existing sill) that is topped by a fixed 3-light transom
- In 4 bays, install a single aluminum door with full-light vision panel, an aluminum 4-light fixed window on the existing sill, and a three light fixed transom

Install new year-round arborvitae in concrete planters

- Planters shall be located at the base of each pilaster as per the attached

Install new seasonal outdoor eating/café area (at 4 bays)

- Add 10 new pruned arborvitae in concrete planters (22" high) on sidewalk
- Install new metal guardrail (painted black) to measure 36" in height
- Install three new canopies, each of which shall include be constructed on canvas mounted on painted metal frame and supported by painted metal posts mounted to the sidewalk. Please note that the canopies/awnings will be *free standing/will not be affixed* to the building and therefore will not result in the addition of bolt holes the building's exterior cladding
- Install string lights
- Install new lounge seating (couches, chairs, and tables) in addition to new 4-top (30"x48"x30") and 2-top (24"x30"x30") tables and associated chairs

Install new signage

- As per the attached, the new signage shall measure 10'-0" in length and shall include 4" polished flat cut, stainless steel letters mounted 3" off the face of the granite which read



CITY OF DETROIT
HISTORIC DISTRICT COMMISSION

65 CADILLAC SQ., SUITE 1300
DETROIT, MICHIGAN 48226
PHONE 313-224-6536
FAX 313-224-1310

“BAR” and “KITCHEN” and 10” high individual painted metal channel letters with white halo lighting which reads “CENTRAL”

However, please note that this COA has been issued with the following conditions:

- The applicant shall comply with installing removable outdoor café equipment that can be removed from the public right-of-way during the months of December through March. Also, and no off-premises advertising signs shall be installed within the outdoor café area
- All items associated with the canopies/awnings shall meet the structural conditions of required by the Detroit Building, Safety, Engineering and Environmental Department
- All work proposed for installation in the public right-of-way be approved by the Detroit Department of Public Works, City Engineering Division
- The applicant shall insure that the Detroit City Council approve the proposed sidewalk outdoor eating/café area prior to its installation
- The finish color of the aluminum at the proposed new doors and windows be consistent with the building’s existing first-story storefront fenestration

Please retain this Certificate of Appropriateness for your files. You should now proceed to the City of Detroit Buildings Safety and Engineering Department to obtain a building permit. The Detroit Historic District Commission’s approval and issuance of a Certificate of Appropriateness does not waive the applicant’s responsibility to comply with any other applicable ordinances or statutes. If you have any questions regarding this letter, please contact me at (313) 224-6543.

For the Commission:

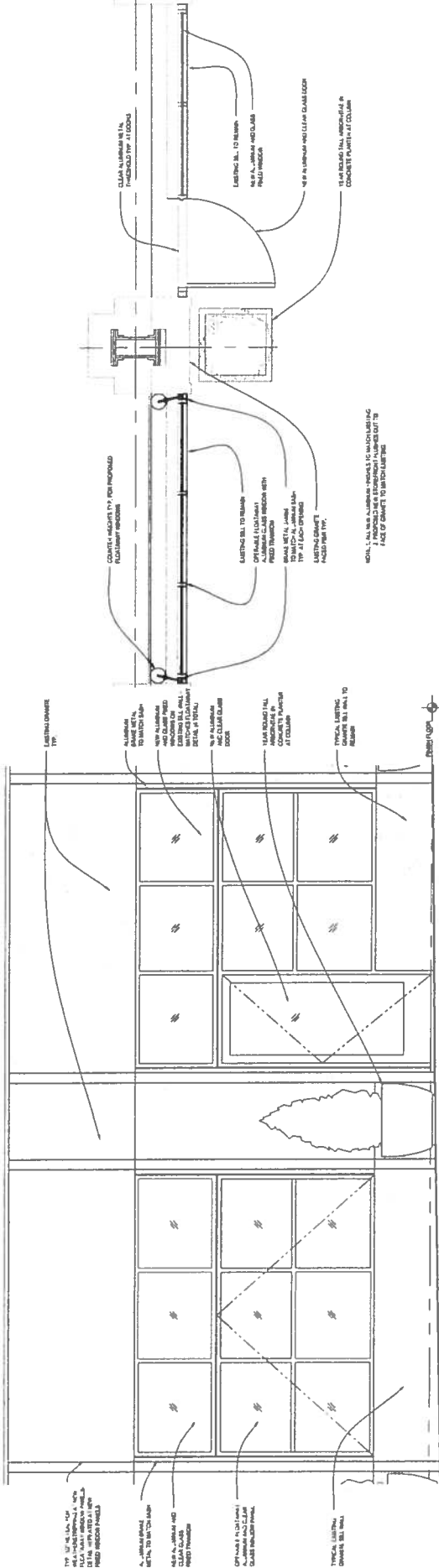

Jennifer Ross, Staff

Detroit Historic District Commission

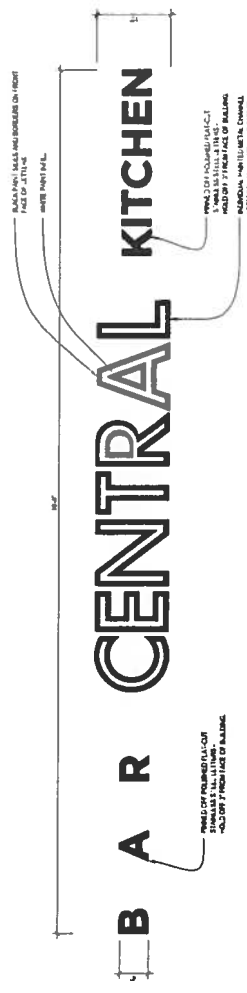

1 ENLARGED FLOOR PLAN
 1/8" = 1'-0"

2 ENLARGED ELEVATION
 1/8" = 1'-0"



1 ENLARGED FLOOR PLAN
 1/8" = 1'-0"

2 ENLARGED ELEVATION
 1/8" = 1'-0"

PERMANENT WALL SECTION
 1/8" = 1'-0"

PERMANENT WALL SECTION
 1/8" = 1'-0"

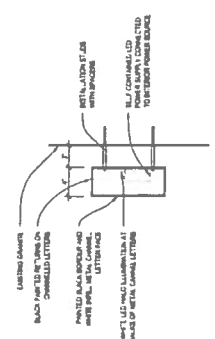

1 ENLARGED FLOOR PLAN
 1/8" = 1'-0"

2 ENLARGED ELEVATION
 1/8" = 1'-0"

PERMANENT WALL SECTION
 1/8" = 1'-0"

APPLICATION NUMBER 15-06

ADDRESS: 660 WOODWARD

APPLICANT: JOHN OLSZEWSKI (BEDROCK ENTERPRISES)

HISTORIC DISTRICT: DETROIT FINANCIAL

PROPOSAL

The property, the First National Bank Building, is located at 660 Woodward in the Detroit Financial Historic District. Albert Kahn, Inc., architect provided the design for the Neo-Classical style building, which was erected in 1920-1922. The building rises 25 stories in height. The primary facades front on Woodward Avenue and Cadillac Square and feature ground-level storefronts that are finished with grey granite. The ground-level storefront bays are arranged in a rhythmic pattern and are composed of fixed steel frame windows that are flanked by 4'-0"- wide pilasters which extend approximately 2" from the building's face. Massive fluted limestone Corinthian columns in antis rise from the second story on the primary facades, repeating/reinforcing the rhythm established by the ground-level granite pilasters. The building's side façade, which faces on to Cadillac Square, and rear, alley-facing façades are finished with limestone and buff colored common brick.

At the Commission's 10-23-2013 meeting, this body approved an extensive scope of work to be undertaken at 660 Woodward's north façade, first-story storefront in order to accommodate the location of a new retail establishment (Papa Joe's Gourmet Market and Catering) within the building's interior space. Specific work items approved by this body at the 10-23-2013 meeting include the replacement of the existing fixed steel and glass storefront windows at the building's north elevation, with a combination of new fixed aluminum and glass storefront windows, bifold/operable aluminum and glass doors, and sliding aluminum and glass doors. The Commission also approved the installation of a new seasonal outdoor eating/café area at this location. Please see the **attached for the staff report**, and **Commission-approved drawings** which are associated with the 10-23-2013 submittal. It is noted that existing granite cladding and windows at the north façade, first-story storefront are not original and/or historic-age as they were installed ca. 1980.

The applicant recently contacted HDC staff to note that Papa Joe's Gourmet Market and Catering was no longer in cue to occupy the first-story retail space at the 660 Woodward. He further noted that a new tenant would be slated to lease the space (Central Bar and Kitchen), which would necessitate a revision of the previously-approved proposal for the building's north façade, first-story storefront. With the **current proposal**, the applicant is submitting the following work items to this body for your review and approval:

Reconfigure existing fenestration (windows) at the 9 easternmost bays as per the attached:

- Remove existing 9-light fixed steel windows
- Install new aluminum windows in 5 bays, each of which consists of an operable 6-light **floataway window panel** (on existing sill) that is topped by a fixed 3-light transom
- In 4 bays, install a single aluminum door with full-light vision panel, an aluminum 4-light fixed window on the existing sill, and a three light fixed transom

Install new year-round arborvitae in concrete planters

- Planters shall be located at the base of each pilaster **as per the attached**

Install new seasonal outdoor eating/café area (at 4 bays)

- Add 10 new pruned arborvitae in concrete planters (22” high) on sidewalk
- Install new metal guardrail (painted black) to measure 36” in height
- Install three new canopies, each of which shall include be constructed on canvas mounted on painted metal frame and supported by painted metal posts mounted to the sidewalk. Please note that the canopies/awnings will be *free standing/will not be affixed* to the building and therefore will not result in the addition of bolt holes the building’s exterior cladding
- Install string lights
- Install new **lounging seating** (couches, chairs, and tables) in addition to new 4-top (30”x48”x30”) and 2-top (24”x30”x30”) **tables and associated chairs**

Install new signage

- **As per the attached**, the new signage shall measure 10’-0” in length and shall include 4” polished flat cut, stainless steel letters mounted 3” off the face of the granite which read “BAR” and “KITCHEN” and 10” high individual painted metal channel letters with white halo lighting which reads “CENTRAL”

APPLICABLE ELEMENTS OF DESIGN .

- (1) *Proportion of Buildings' Front Façades.* The proportions of individual front façades vary greatly within the district. Buildings over ten (10) stories tall are significantly taller than wide, and are usually located on corners of blocks or occupy their entire block. Most other buildings in the district are also taller than wide, with notable exceptions of several buildings facing West Fort Street, the Detroit Fire Department Headquarters at 250 East Larned Avenue, and a few smaller buildings on Shelby Street, which are wider than tall or proportionally neutral. The non-contributing building at 501 Woodward Avenue and the building at 611 Woodward Avenue are significantly wider than tall. Buildings with front-facing light courts, such as the Dime Building at 719 Griswold Street, appear to have two tall towers projecting upward from a single, multi-story base. The façades of the Neoclassical style First National Building at 660 Woodward Avenue follow the irregular footprint of its site, and because of its substantial height, provide a backdrop to the small-scaled buildings adjacent to it on Woodward Avenue. Skyscraper buildings of the Art Deco have multiple setbacks in their wall surfaces as the buildings rise, with faceted and decorative results. The Detroit Free Press Building at 321 West Lafayette Street is composed of a center tower with two lower wings, neutralizing its proportions. Tall buildings of the International style tend to rise as a single slab. Where buildings that are individually taller than wide either share a party wall or abut each other, they may collectively form a row that is wider than tall, particularly on the east side of Woodward Avenue.
- (2) *Proportion of Openings Within the Façades.* The buildings within the Historic Detroit Financial District are each composed of approximately thirty-five (35) to sixty (60) per cent openings in their front façades. Shapes and sizes of openings

generally depend on the style and age of the buildings. Entrances are often centered prominently on the front façades, with revolving doors set back in an arched, covered area or portico. Large openings above the entrance openings, ground floors, and mezzanine levels in the base of the buildings frequently contain subdivided windows rising up through multiple stories. Plate glass storefront and display windows on the ground floors of commercial buildings are commonplace. Above the ornate bases of Neoclassical and Art Deco style buildings and simpler Victorian buildings are rows of double-hung sash windows that are twice as tall as wide and are often arranged in pairs or triples, sometimes divided vertically by spandrels. Subdivided glazing is often situated within large, ornate arched, square or rectangular openings in the attic stories. Replacement windows that are fitted to existing openings are common in the district. Some International style buildings with curtain wall construction feature undivided faces of fixed pane glass, or individualized treatments, such as hexagonal shaped window glass in precast concrete frames of 1 Woodward Avenue.

- (3) *Rhythm of Solids to Voids in the Front Façade.* Most buildings in the district are of steel-frame construction, which creates a structure for which windows are inserted in a regular arrangement of columns and rows between the base floor and the attic. The regular rhythm of windows arranged one over the other in a grid pattern prevails throughout the district. The base and attic stories of buildings are varied in architectural treatment, but may feature regular rhythms of arched, square or rectangular openings on first and attic stories. The Detroit Fire Department Headquarters at 250 West Larned Street features double firehouse doors within arcaded openings on its Washington Boulevard and West Larned Street façades. The International style building at 611 Woodward Avenue features a checkerboard pattern of window placement, while the Federal Reserve Bank Annex at 160 West Fort Street features alternating horizontal bands of glass and marble panels supported by a stainless steel grid above its all-glass tall first story. In general, the district displays a variety of regularly arranged fenestration patterns.
- (4) *Rhythm of Entrance and/or Porch Projections.* Most primary entrances are prominently centered on their front façades, especially on the classically derived buildings, and are commonly recessed within single or multiple ornamental openings. Some buildings have colonnades or monumental porticos, with their entrances set behind. International style buildings often have entire base stories recessed behind a colonnade of piers. The Guardian Building at 500 Griswold Street has its main entrance at its northwest corner, and Victorian commercial buildings along Woodward tend to have entrances to the sides of storefronts. Some corner buildings have corner entrances. Most entrances are at grade, with the exceptions of the buildings at 611 Woodward Avenue and the west elevation of 211 West Fort Street, which each feature a set of steps that rise with the slope of their sites, and United States District Court at 231 West Lafayette Street, which sits on a high basement and has steps leading to its main entrance.

- (5) *Relationship of Materials.* A great variety of building materials exist throughout the district, with concentrations of finished, pressed or glazed brick, limestone, Mankato stone, terra cotta, marble; cast and porcelain enamel and glass facing primary façades. Base stories are commonly faced or partially faced in granite. Materials utilized for window surrounds and frames are cast concrete, steel, aluminum, bronze and wood. Architectural embellishments tend to be in cast and carved stone, glazed terra cotta, Pewabic tile, and red sandstone. Common brick appears on side elevations that were not intended to be visible. Bronze grills, metal fire escapes, and aluminum and steel framing elements are also visible. In general, the district is rich in its varieties and relationships of materials.
- (6) *Relationship of Textures.* The smooth surfaces of glazed or painted brick, glazed terra cotta, polished marble, polished granite, and large expanses of glass contrast with the matte finishes of limestone and unpainted brick with mortar joints. Where the bases of buildings are rusticated, they contrast with the smoother wall surfaces above. Repetitive pilasters and ornamental detail in masonry, terra cotta or metal, primarily on belt courses and cornices, and the fluting of columns, contribute significantly to textural interest. Subdivided window sashes and treatments also contribute to textural interest, as do receding windows and wall planes, resulting in textural effects created by light and shade. Where those International style buildings have glass bases, a smooth, transparent textural effect results. In general, the district is extremely rich in textural relationships.
- (7) *Relationship of Colors.* Major materials of light colors, such as beige, white, and cream, dominate the district. The natural brick colors of red, orange, and buff are also contrasted with beige or light gray trim elements and details. Painted brick, where it exists on the east side of Woodward Avenue, is in dark red and cream. Granite bases, where they exist, are black, red or gray. Window surrounds and sashes are shades of green, black, cream or white. Window and curtain wall glass is either colorless or tinted in shades of light green, black or gray. Stainless steel and aluminum are silver in tone; grills and grates are green or black. The Guardian Building at 501 Griswold Avenue is a historic landmark featuring orange brick and colored tile. Light poles tend to be deep green, black or gray. Fire escapes, where they exist, are generally painted black. The original colors of any building, as determined by professional analysis, are always acceptable for that building and may provide guidance for similar buildings.
- (8) *Relationship of Significant Landscape Features and Surface Treatments.* Throughout the district, sidewalks are concrete and roadbeds are asphalt, with the primary exception of brick-paved areas around Campus Martius at the northeast corner of the district. Street furniture is abundant throughout the district; planter boxes for trees are positioned along the public sidewalk on the west side of Woodward Avenue and the north side of West Fort Street, and in-ground trees line the east side of Griswold Street within stylized metal grates reflecting the geometric designs of the Guardian Building at 500 Griswold Street. Wall-mounted lighting fixtures are often integrated with the designs of the buildings and are situated at the

tops of first story pilasters to illuminate the pedestrian way. Also sometimes integrated with the taller buildings is lighting at the upper extremities that identify the buildings from afar, such as the flashing red globe of the Penobscot Building at 645 Griswold Street. The reproduction street lighting along Woodward Avenue consists of a tall steel ornamental, fluted pole carrying a double pendent and lanterns. On Griswold Street, the lighting consists of old metal fluted poles with more recent lanterns. Old ornamental poles exist along Washington Boulevard south of Michigan Avenue; and the modern steel pole mounted variety are seen elsewhere. Some buildings have modern spotlights attached to light posts directed at their façade. Slender black, metal kiosks with directional information and a map are strategically placed at some prominent corners. Surface parking lots are few and provide intrusions to the otherwise dense concentration of buildings where they exist. Concrete columns supporting the Detroit People Mover are situated in the public rights-of-way on West Larned Street as well as Cass Avenue. A bronze sculpture is positioned in the plaza in front of 1 Woodward Avenue and the space between 211 and 201 West Fort Street, and a plaza with raised planting beds exists in front of the Annex of the Federal Reserve Bank at 160 West Fort Street. The curbed, landscaped median on Woodward Avenue identifies the roadway as Detroit's major thoroughfare.

- (9) *Scale of Façade and Façade Elements.* The façades range from small in scale to monumental. Small-and-medium scaled buildings that contribute to the continuous streetscapes contrast with the large scale of skyscrapers that define Detroit's skyline. Elements and details are often monumental, such as porticos, colonnades, architectural sculpture, and large openings, and are meant to provide a grand presence when seen from upfront and afar.
- (10) *Degree of Complexity Within the Façades.* The district contains façades with various degrees of complexity, depending on style. The Victorian commercial and Neoclassical buildings are straightforward in their massing, fenestration, and architectural detail. The Art Deco skyscrapers appear more complex in their details and ornamentation, but especially in their massing as the setbacks of the upper stories display different massing and heightened detail. Modern buildings may appear straightforward in their design but are complex in their geometric forms, use of materials, and subtle detail.
- (11) *Symmetric or Asymmetric Appearance.* While individual buildings display a high degree of symmetry in their major façades, the district on the whole is diverse in its array of quality building designs.
- (12) *General Environmental Character.* The Historic Detroit Financial District consists of a dense cluster of major, architect-designed commercial buildings in an eight-block, grid-plan section of downtown Detroit just north of Hart Plaza and the Detroit River. Its historical importance is emphasized by its number of iconic buildings that make up Detroit's skyline, and its smaller buildings that result in a walkable downtown. The Detroit Department of Transportation-operated bus

system and the People Mover provide transportation in and around the district, providing ease of access to major sporting events, conventions, and restaurants, in addition to the historic buildings that are destinations in and of themselves.

RECOMMENDATION

It is HDC staff's opinion that the work as proposed will not result in the removal of significant historic-age architectural elements at the building. HDC Staff therefore recommends that the Commission issue a Certificate of Appropriateness (COA) for the work as proposed because it meets the Secretary of the Interior's Standards for Rehabilitation standard number 9) *New additions, exterior alterations, or related new construction shall not destroy historic materials that characterize the property. The new work shall be differentiated from the old and shall be compatible with the massing, size, scale, and architectural features to protect the historic integrity of the property and its environment.*

However, staff recommends that the above-referenced COA be issued with the following conditions:

- The applicant shall comply with installing removable outdoor café equipment that can be removed from the public right-of-way during the months of December through March. Also, and no off-premises advertising signs shall be installed within the outdoor café area
- All items associated with the canopies/awnings shall meet the structural conditions of required by the Detroit Building, Safety, Engineering and Environmental Department
- All work proposed for installation in the public right-of-way be approved by the Detroit Department of Public Works, City Engineering Division
- The applicant shall insure that the Detroit City Council approve the proposed sidewalk outdoor eating/café area prior to its installation
- The finish color of the aluminum at the proposed new doors and windows be consistent with the building's existing first-story storefront fenestration